



WWW.MILL-MAX.COM

MALE PCB PINS





WWW.MILL-MAX.COM

MILL-MAX PRINTED CIRCUIT PINS ARE MACHINED INDIVIDUAL PINS USED FOR VARIOUS PLUG-IN APPLICATIONS AND ARE FUNCTIONALLY THE DYNAMIC BUILDING BLOCKS WITHIN AN INTERCONNECT SYSTEM.

Mill-Max offers a variety of pins in a broad range of diameters as well as turret, slotted, bifurcated (forked), soldercup and wrapost style pins. They are commonly fastened to printed circuit boards or other housings by being press-fit, swaged (riveted) or soldered.

PCB pins serve not only as a conductive path for an electrical circuit, but provide strength to an assembly module as a mechanical interface. Mill-Max Mfg. Corp. has developed thousands of state-of-the-art "basic pin" designs, featuring pin barrel geometries for our customers who require outside-the-box solutions to their interconnect needs.

In addition to the products found on the following pages, Mill-Max offers the following stock materials and diameters available for manufacture:

BRASS Alloy 360, 1/2 hard: .062/.072/.078/.093/.125/.156/.187/.250 diameters

PHOSPHOR BRONZE Alloy 544: .062/.072/.078 diameters

TELLURIUM COPPER Alloy 145: .079/.093/.125/.156 diameters

Mill-Max will gladly quote application specific products. Please complete the specification sheet on page **247** or send us your own drawings.

We assure you a fast response.

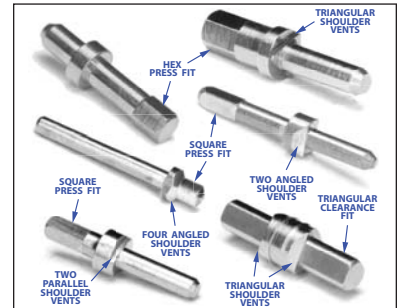
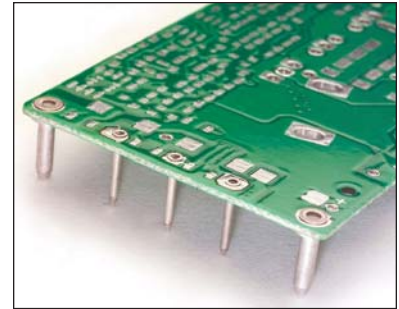

MALE PCB PINS

PRINTED CIRCUIT PINS • NAIL HEAD TYPE

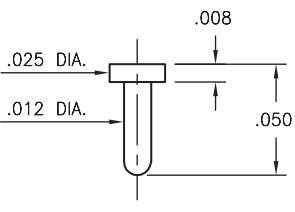
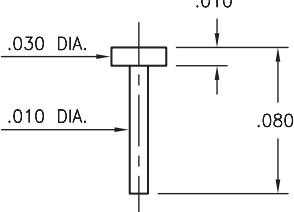
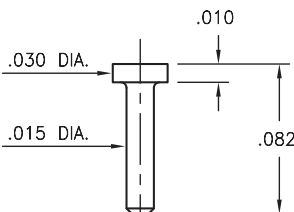
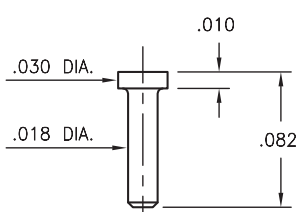
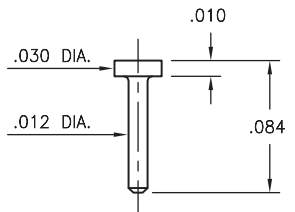
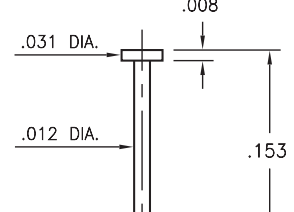
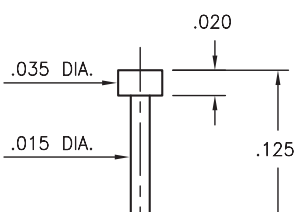
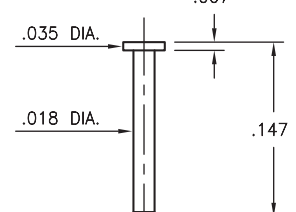
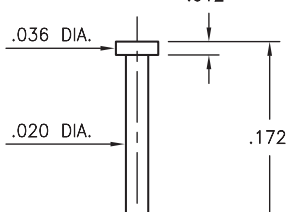
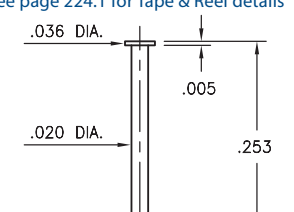
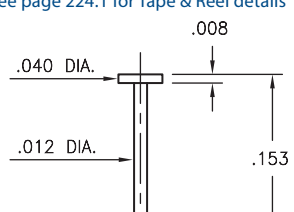
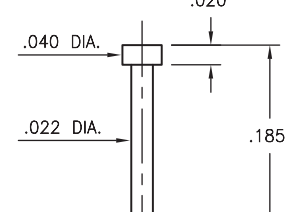
<p>9050 9050-0-00-XX-00-00-33-0 Solder mount in .016 mounting hole</p> 	<p>4184 4184-0-00-XX-00-00-33-0 Solder mount in .014 mounting hole</p> 	<p>4825 4825-0-00-XX-00-00-33-0 Solder mount in .019 mounting hole Also available on 16mm wide carrier tape: 3,250 parts per 13" reel. See page 224.1 for Tape & Reel details</p> 	<p>4288 4288-0-00-XX-00-00-33-0 Solder mount in .022 mounting hole Also available on 16mm wide carrier tape: 3,250 parts per 13" reel. See page 224.1 for Tape & Reel details</p> 
<p>4353 4353-0-00-XX-00-00-33-0 Solder mount in .016 mounting hole Also available on 16mm wide carrier tape: 3,040 parts per 13" reel. See page 224.1 for Tape & Reel details</p> 	<p>6083 6083-0-00-XX-00-00-03-0 Solder mount in .016 mounting hole</p> 	<p>4689 4689-0-00-XX-00-00-33-0 Solder mount in .019 mounting hole</p> 	<p>4068 4068-0-00-XX-00-00-33-0 Solder mount in .022 mounting hole Also available on 16mm wide carrier tape: 2,000 parts per 13" reel. See page 224.1 for Tape & Reel details</p> 
<p>5063 5063-0-00-XX-00-00-33-0 Solder mount in .024 mounting hole</p> 	<p>6547 6547-0-00-XX-00-00-33-0 Solder mount in .024 mounting hole Also available on 24mm wide carrier tape: 1,080 parts per 13" reel. See page 224.1 for Tape & Reel details</p> 	<p>9083 9083-0-00-XX-00-00-38-0 Solder mount in .016 mounting hole Also available on 16mm wide carrier tape: 1,950 parts per 13" reel. See page 224.1 for Tape & Reel details</p> 	<p>9185 9185-0-00-XX-00-00-33-0 Solder mount in .026 mounting hole</p> 

SPECIFICATIONS:

Pin Material: Brass Alloy 360, 1/2 Hard
(Except where noted)

Dimensions: Inches

Tolerances On: Lengths: $\pm .005$
Diameters: $\pm .002$
Angles: $\pm 2^\circ$



ORDER CODE: XXXX - X - 00 - XX - 00 - 00 - XX - 0

BASIC PART # →

SPECIFY PIN FINISH:

- 01 200 μ m TIN/LEAD OVER NICKEL
- ◆ 80 200 μ m TIN OVER NICKEL (RoHS)
- ◆ 15 10 μ m GOLD OVER NICKEL (RoHS)
- ◆ 21 20 μ m GOLD OVER NICKEL (RoHS)
- ◆ 34 50 μ m GOLD OVER NICKEL (RoHS)



MALE PCB PINS

PRINTED CIRCUIT PINS • NAIL HEAD TYPE

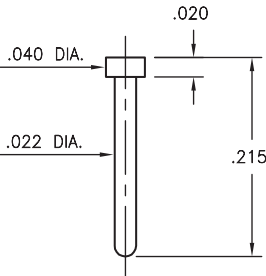
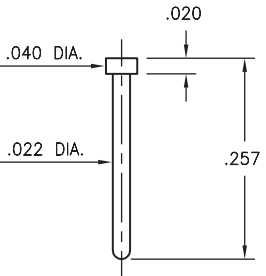
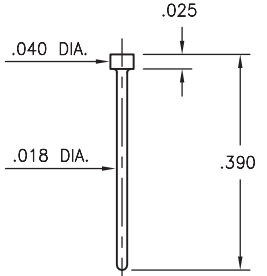
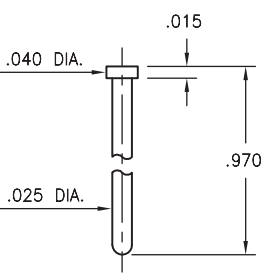
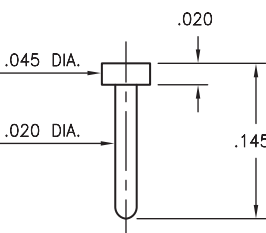
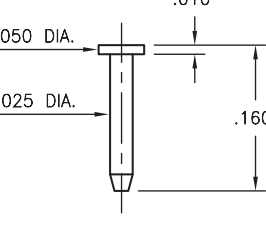
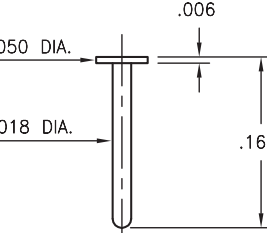
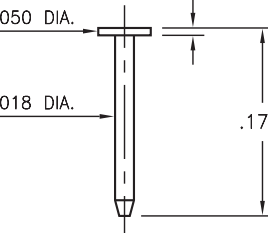
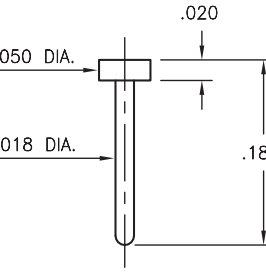
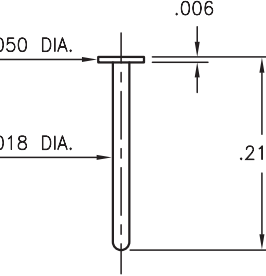
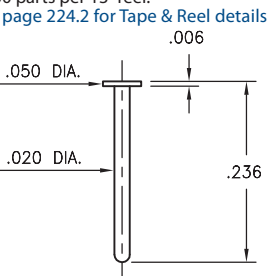
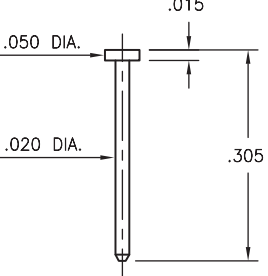
<p>8277 8277-0-00-XX-00-00-03-0 Solder mount in .026 mounting hole</p> 	<p>8257 8257-0-00-XX-00-00-33-0 Solder mount in .026 mounting hole</p> 	<p>4209 4209-0-00-XX-00-00-33-0 Solder mount in .022 mounting hole</p> 	<p>8451 8451-0-00-XX-00-00-33-0 Solder mount in .029 mounting hole</p> 
<p>5058 5058-0-00-XX-00-00-03-0 Solder mount in .024 mounting hole Also available on 16mm wide carrier tape: 2,000 parts per 13" reel. See page 224.2 for Tape & Reel details</p> 	<p>5035 5035-0-00-XX-00-00-33-0 Solder mount in .029 mounting hole</p> 	<p>9113 9113-0-00-XX-00-00-38-0 Solder mount in .022 mounting hole Also available on 16mm wide carrier tape: 1,800 parts per 13" reel. See page 224.2 for Tape & Reel details</p> 	<p>5068 5068-0-00-XX-00-00-03-0 Solder mount in .022 mounting hole</p> 
<p>9137 9137-0-00-XX-00-00-38-0 Solder mount in .022 mounting hole</p> 	<p>7113 7113-0-00-XX-00-00-03-0 Solder mount in .022 mounting hole</p> 	<p>4965 4965-0-00-XX-00-00-33-0 Solder mount in .024 mounting hole Also available on 24mm wide carrier tape: 1,300 parts per 13" reel. See page 224.2 for Tape & Reel details</p> 	<p>4071 4071-0-00-XX-00-00-33-0 Solder mount in .024 mounting hole</p> 

SPECIFICATIONS:

Pin Material: Brass Alloy 360, 1/2 Hard
(Except where noted)

Dimensions: Inches

Tolerances On: Lengths: $\pm .005$
Diameters: $\pm .002$
Angles: $\pm 2^\circ$



ORDER CODE: XXXX - X - 00 - XX - 00 - 00 - XX - 0

BASIC PART #

SPECIFY PIN FINISH:

- 01 200 μ " TIN/LEAD OVER NICKEL
- ◆ 80 200 μ " TIN OVER NICKEL (RoHS)
- ◆ 15 10 μ " GOLD OVER NICKEL (RoHS)
- ◆ 21 20 μ " GOLD OVER NICKEL (RoHS)
- ◆ 34 50 μ " GOLD OVER NICKEL (RoHS)



MALE PCB PINS

PRINTED CIRCUIT PINS • NAIL HEAD TYPE

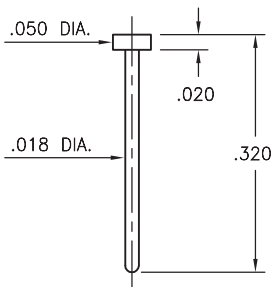
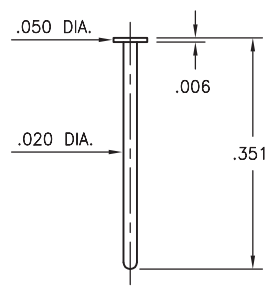
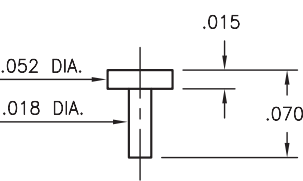
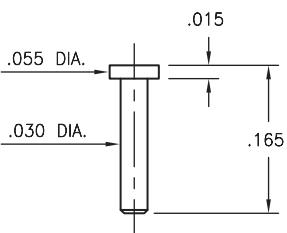
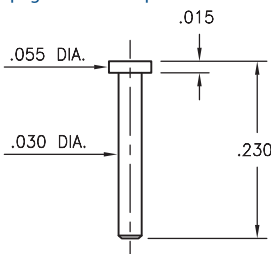
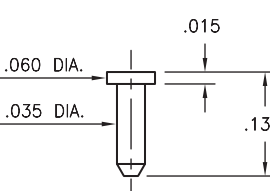
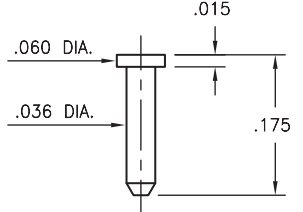
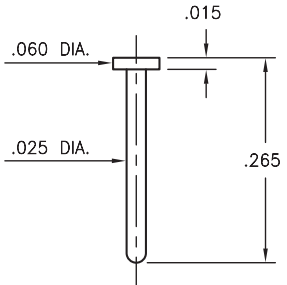
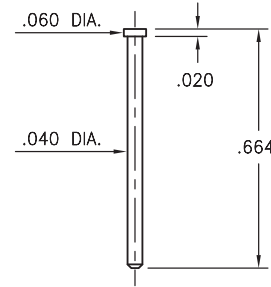
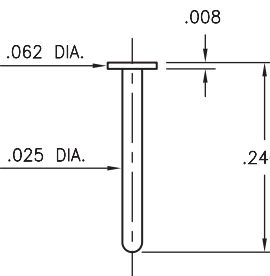
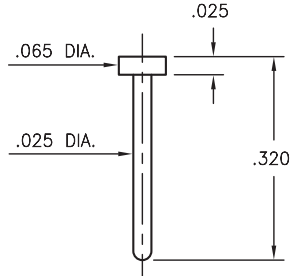
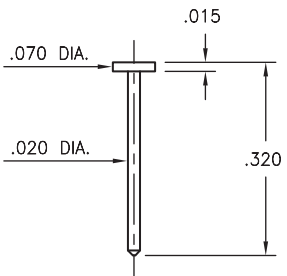
<p>5137 5137-0-00-XX-00-00-38-0 Solder mount in .022 mounting hole</p> 	<p>4964 4964-0-00-XX-00-00-33-0 Solder mount in .024 mounting hole</p> 	<p>4361 4361-0-00-XX-00-00-33-0 Solder mount in .022 mounting hole Also available on 16mm wide carrier tape: 3,600 parts per 13" reel. See page 224.2 for Tape & Reel details</p> 	<p>6477 6477-0-00-XX-00-00-38-0 Solder mount in .034 mounting hole</p> 
<p>4477 4477-0-00-XX-00-00-33-0 Solder mount in .034 mounting hole Also available on 24mm wide carrier tape: 1,300 parts per 13" reel. See page 224.2 for Tape & Reel details</p> 	<p>4268 4268-0-00-XX-00-00-33-0 Solder mount in .039 mounting hole</p> 	<p>9086 9086-0-00-XX-00-00-33-0 Solder mount in .040 mounting hole</p> 	<p>5850 5850-0-00-XX-00-00-03-0 Solder mount in .029 mounting hole</p> 
<p>1179 1179-0-00-XX-00-00-33-0 Solder mount in .044 mounting hole</p> 	<p>5240 5240-0-00-XX-00-00-33-0 Solder mount in .029 mounting hole</p> 	<p>6170 6170-0-00-XX-00-00-03-0 Solder mount in .029 mounting hole</p> 	<p>8808 8808-0-00-XX-00-00-33-0 Solder mount in .024 mounting hole</p> 

SPECIFICATIONS:

Pin Material: Brass Alloy 360, 1/2 Hard
(Except where noted)

Dimensions: Inches

Tolerances On: Lengths: $\pm .005$
Diameters: $\pm .002$
Angles: $\pm 2^\circ$



ORDER CODE: XXXX - X - 00 - XX - 00 - 00 - XX - 0

BASIC PART # →

→ **SPECIFY PIN FINISH:**

- 01 200 μ " TIN/LEAD OVER NICKEL
- ◆ 80 200 μ " TIN OVER NICKEL (RoHS)
- ◆ 15 10 μ " GOLD OVER NICKEL (RoHS)
- ◆ 21 20 μ " GOLD OVER NICKEL (RoHS)
- ◆ 34 50 μ " GOLD OVER NICKEL (RoHS)



MALE PCB PINS

PRINTED CIRCUIT PINS • NAIL HEAD TYPE

8330

8330-0-00-XX-00-00-38-0
Solder mount in .044 mounting hole
Also available on 24mm wide carrier tape:
610 parts per 13" reel.
See page 224.3 for Tape & Reel details

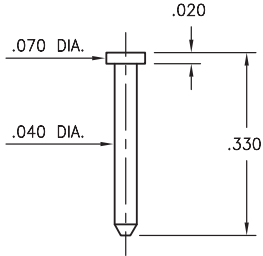

6599

6599-0-00-XX-00-00-03-0
Solder mount in .024 mounting hole

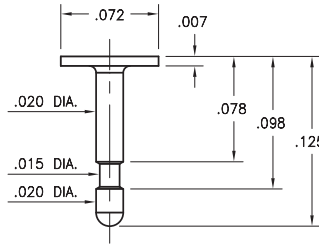

9265

9265-0-00-XX-00-00-38-0
Solder mount in .063 mounting hole
Also available on 16mm wide carrier tape:
1,170 parts per 13" reel.
See page 224.3 for Tape & Reel details

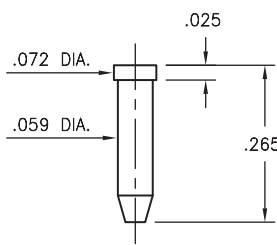

2650

2650-0-00-XX-00-00-33-0
Solder mount in .029 mounting hole

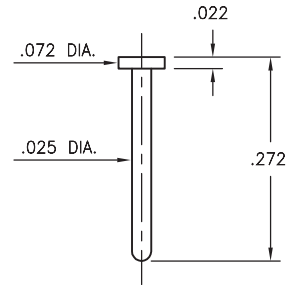

9872

9872-0-00-XX-00-00-33-0
Solder mount in .049 mounting hole

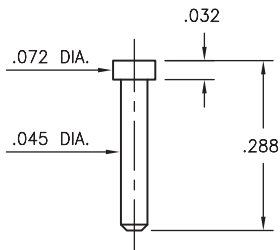

9228

9228-0-00-XX-00-00-38-0
Solder mount in .044 mounting hole

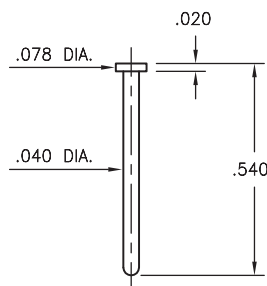

6095

6095-X-00-XX-00-00-38-0
Solder mount in .044 mounting hole

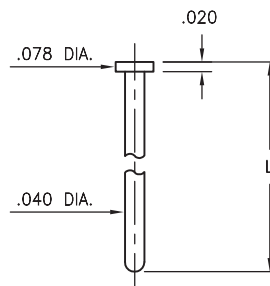

Basic Part Number	Length L
6095-0	.580
6095-1	.475

6092

6092-0-00-XX-00-00-33-0
Solder mount in .044 mounting hole

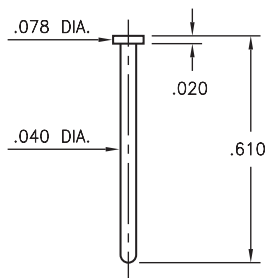

5909

5909-0-00-XX-00-00-03-0
Solder mount in .044 mounting hole

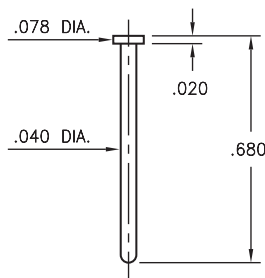

2381

2381-0-00-XX-00-00-33-0
Solder mount in .054 mounting hole
Also available on 16mm wide carrier tape:
1,800 parts per 13" reel.
See page 224.3 for Tape & Reel details

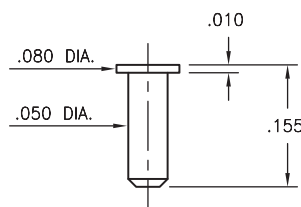

5062

5062-0-00-XX-00-00-33-0
Solder mount in .029 mounting hole

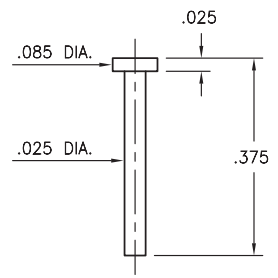

SPECIFICATIONS:

Pin Material: Brass Alloy 360, 1/2 Hard
(Except where noted)

Dimensions: Inches

Tolerances On: Lengths: ± .005
Diameters: ± .002
Angles: ± 2°



ORDER CODE: XXXX - 0 - 00 - XX - 00 - 00 - XX - 0

BASIC PART # →

SPECIFY PIN FINISH:

- 01 200 μ" TIN/LEAD OVER NICKEL
- ◆ 80 200 μ" TIN OVER NICKEL (RoHS)
- ◆ 15 10 μ" GOLD OVER NICKEL (RoHS)
- ◆ 21 20 μ" GOLD OVER NICKEL (RoHS)
- ◆ 34 50 μ" GOLD OVER NICKEL (RoHS)



MALE PCB PINS

PRINTED CIRCUIT PINS • NAIL HEAD TYPE

4541

4541-0-00-XX-00-00-03-0

Solder mount in .022 mounting hole

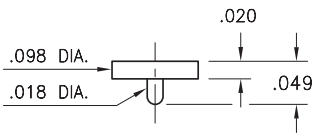

6142

6142-0-00-XX-00-00-33-0

Solder mount in .064 mounting hole

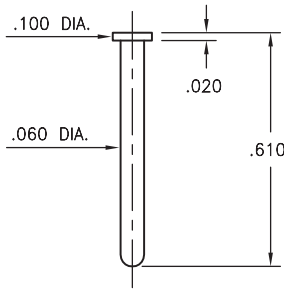

5910

5910-0-00-XX-00-00-03-0

Solder mount in .084 mounting hole

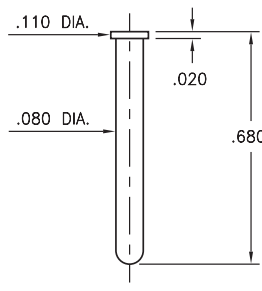

9022

9022-0-00-XX-00-00-33-0

Solder mount in .066 mounting hole
Also available on 24mm wide carrier tape:
1,500 parts per 13" reel.
See page 224.4 for Tape & Reel details

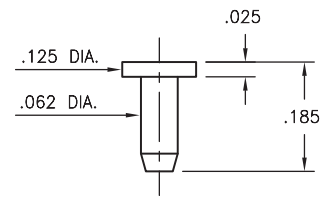

8086

8086-0-00-XX-00-00-33-0

Solder mount in .079 mounting hole
Also available on 12mm wide carrier tape:
550 parts per 13" reel.
See page 224.4 for Tape & Reel details

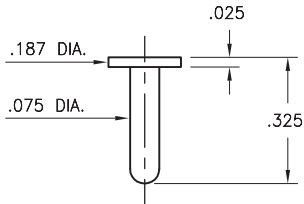

8086

8086-0-00-XX-00-00-33-0

Surface mount
Also available on 24mm wide carrier tape:
450 parts per 13" reel.
See page 224.4 for Tape & Reel details

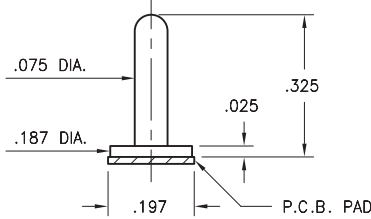

P.C.B. Layout

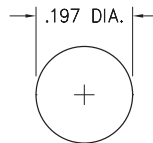

SPECIFICATIONS:

Pin Material: Brass Alloy 360, 1/2 Hard
(Except where noted)

Dimensions: Inches

Tolerances On: Lengths: $\pm .005$
Diameters: $\pm .002$
Angles: $\pm 2^\circ$



ORDER CODE: XXXX - X - 00 - XX - 00 - 00 - XX - 0

BASIC PART # →

→ **SPECIFY PIN FINISH:**

- 01 200 μ m TIN/LEAD OVER NICKEL
- ◆ 80 200 μ m TIN OVER NICKEL (RoHS)
- ◆ 15 10 μ m GOLD OVER NICKEL (RoHS)
- ◆ 21 20 μ m GOLD OVER NICKEL (RoHS)
- ◆ 34 50 μ m GOLD OVER NICKEL (RoHS)

MALE PCB PINS

STRAIGHT PINS

3320

3320-X-00-XX-00-00-03-0

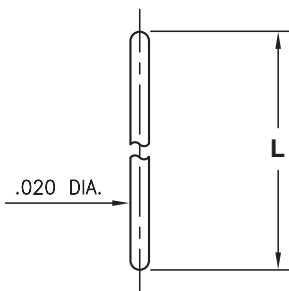

Basic Part Number	Length L
3320-0	.250
3320-1	.500

3325/6527

XXXX-X-00-XX-00-00-03-0

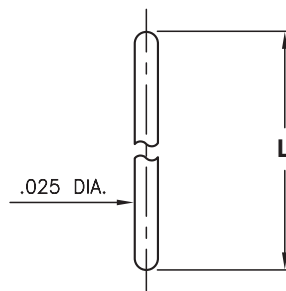

Basic Part Number	Length L
3325-0	.250
3325-1	.500
3325-2	.750
6527-0	.420

3330

3330-X-00-XX-00-00-03-0

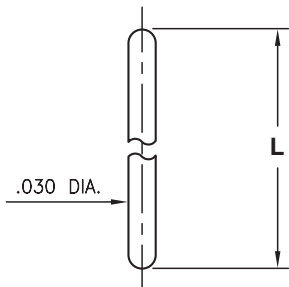

Basic Part Number	Length L
3330-0	.250
3330-1	.500
3330-2	.750

3340

3340-X-00-XX-00-00-03-0

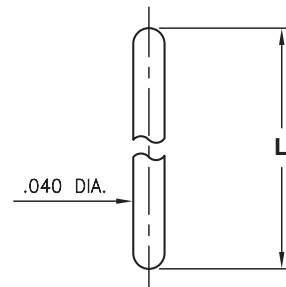

Basic Part Number	Length L
3340-0	.250
3340-1	.500
3340-2	.750

3560

3560-X-00-XX-00-00-03-0

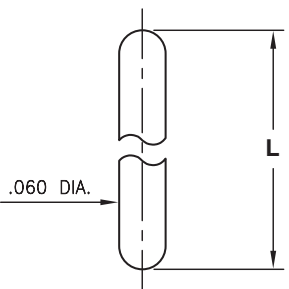

Basic Part Number	Length L
3560-0	.250
3560-1	.500
3560-2	.750

3580

3580-X-00-XX-00-00-03-0

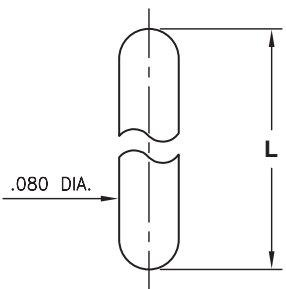

Basic Part Number	Length L
3580-0	.250
3580-1	.500
3580-2	.750

SPECIFICATIONS:

Pin Material: Brass Alloy 360, 1/2 Hard
(Except where noted)

Dimensions: Inches

Tolerances On: Lengths: $\pm .005$
Diameters: $\pm .002$
Angles: $\pm 2^\circ$



ORDER CODE: XXXX - X - 00 - XX - 00 - 00 - 03 - 0

BASIC PART # →

← **SPECIFY PIN FINISH:**

- ◆ 80 200 μ " TIN OVER NICKEL (RoHS)
- ◆ 15 10 μ " GOLD OVER NICKEL (RoHS)



MALE PCB PINS

RIGHT ANGLE PINS

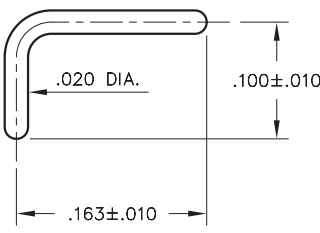
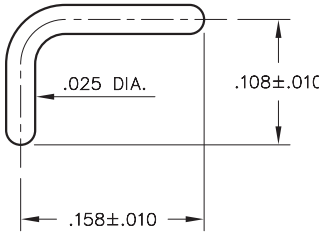
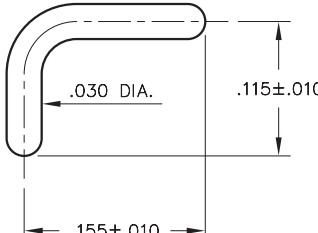
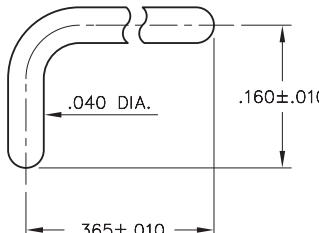
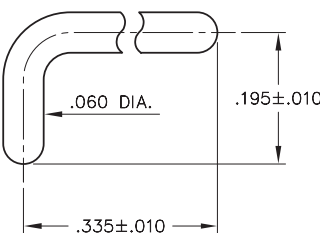
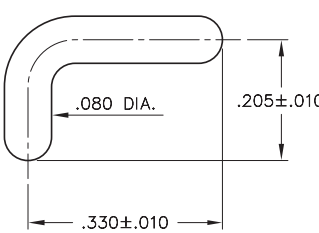
<p>3720 3720-0-14-XX-00-00-03-0 Right Angle Bent Pin</p> 	<p>3725 3725-0-14-XX-00-00-03-0 Right Angle Bent Pin</p> 	<p>3730 3730-0-14-XX-00-00-03-0 Right Angle Bent Pin</p> 	<p>3740 3740-0-14-XX-00-00-03-0 Right Angle Bent Pin</p> 
<p>3760 3760-0-14-XX-00-00-03-0 Right Angle Bent Pin</p> 	<p>3780 3780-0-14-XX-00-00-03-0 Right Angle Bent Pin</p> 		

SPECIFICATIONS:

Pin Material: Brass Alloy 360, 1/2 Hard
(Except where noted)

Dimensions: Inches

Tolerances On: Lengths: ±.005
Diameters: ±.002
Angles: ± 2°



ORDER CODE: 37XX - X - 00 - XX - 00 - 00 - 03 - 0

BASIC PART #

SPECIFY PIN FINISH:

- ◆ 80 200 μ" TIN OVER NICKEL (RoHS)
- ◆ 15 10 μ" GOLD OVER NICKEL (RoHS)



MALE PCB PINS

PRINTED CIRCUIT PINS

4006

4006-X-00-XX-00-00-03-0

Hex press-fit in .034 mounting hole

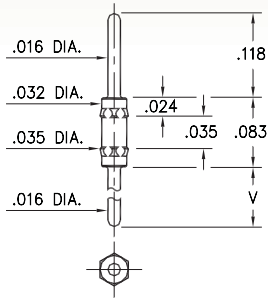

Basic Part Number	Length V
4006-0	.118
4006-1	.188
4006-2	.288

3121

3121-X-00-XX-00-00-08-0

Solder mount in .023 mounting hole
Material is annealed.

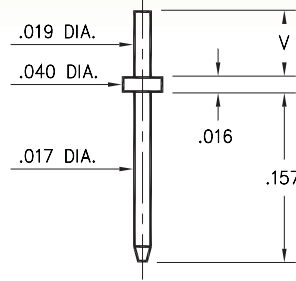

Basic Part Number	Substrate Thickness	Length V
3121-1	.025	.061
3121-2	.040	.075

3128

3128-X-00-XX-00-00-08-0

Solder mount in .024 min. mounting hole

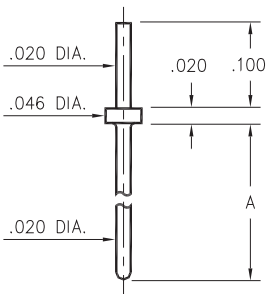

Basic Part Number	Length A
3128-1	.250
3128-2	.425
3128-3	.525
3128-4	.550
3128-5	.930

3006

3006-0-00-XX-00-00-03-0

Press-fit in .034 mounting hole

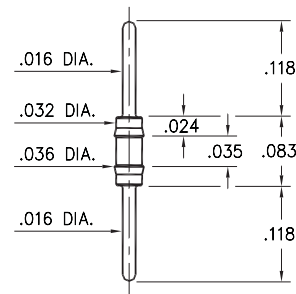

8885

8885-0-00-XX-00-00-03-0

Press-fit in .057 mounting hole

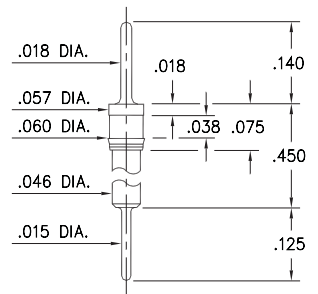

6218

6218-0-00-XX-00-00-03-0

Press-fit in .057 mounting hole

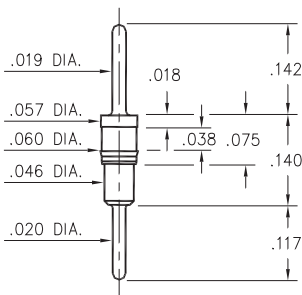

5012

5012-0-00-XX-00-00-03-0

Press-fit in .057 mounting hole

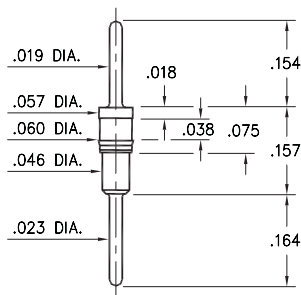

9081

9081-0-00-XX-00-00-08-0

Solder mount in .024 mounting hole

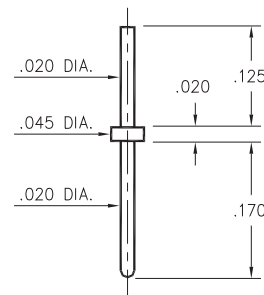

3039

3039-0-00-15-00-00-03-0

Press-fit in .025 mounting hole

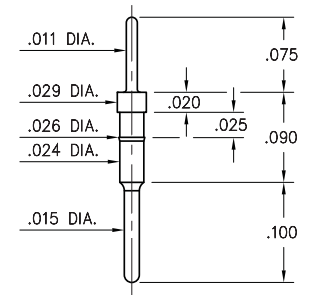

SPECIFICATIONS:

Pin Material: Brass Alloy 360, 1/2 Hard
(Except where noted)

Dimensions: Inches

Tolerances On: Lengths: $\pm .005$
Diameters: $\pm .002$
Angles: $\pm 2^\circ$



ORDER CODE: XXXX - X - 00 - XX - 00 - 00 - XX - 0

BASIC PART #

SPECIFY PIN FINISH:

- 01 200 μ m TIN/LEAD OVER NICKEL
- ◆ 80 200 μ m TIN OVER NICKEL (RoHS)
- ◆ 15 10 μ m GOLD OVER NICKEL (RoHS)
- ◆ 21 20 μ m GOLD OVER NICKEL (RoHS)
- ◆ 34 50 μ m GOLD OVER NICKEL (RoHS)



MALE PCB PINS

PRINTED CIRCUIT PINS

5421

5421-0-00-XX-00-00-03-0

Solder mount in .023 or .021 mounting hole

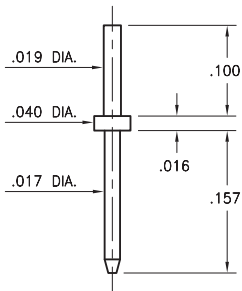

7069

7069-0-00-XX-00-00-03-0

Solder mount in .044 or .024 mounting hole

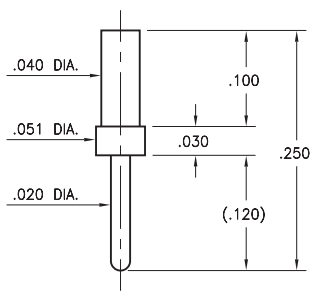

5247

5247-0-00-XX-00-00-03-0

Solder mount in .035 mounting hole

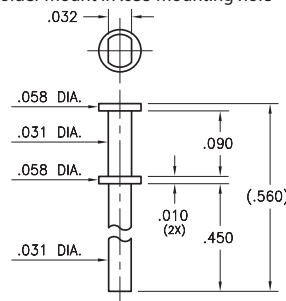

6136

6136-0-00-XX-00-00-03-0

Solder mount in .044 or .034 mounting hole

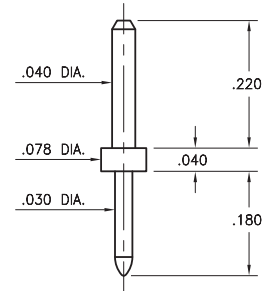

0912/7912

0912-0-00-XX-00-00-03-0

Press-fit in .057 mounting hole

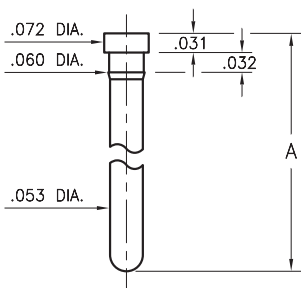

Basic Part Number	Pin Length A
0912-0	.313
7912-0	.510

8836

8836-0-00-XX-00-00-03-0

Press-fit in .075 mounting hole

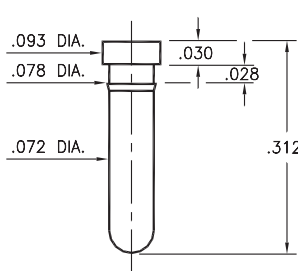

6298

6298-0-00-XX-00-00-03-0

Press-fit in .083 mounting hole

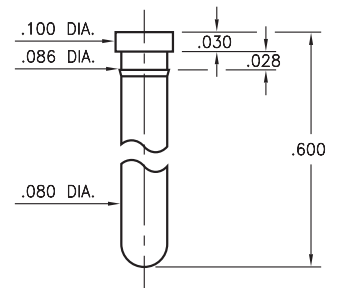

1130

1130-0-00-XX-00-00-03-0

Press-fit in .057 mounting hole
Pin material is Phosphor Bronze 544 (B2)

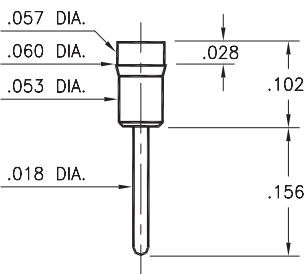

6711

6711-0-00-XX-00-00-03-0

Solder mount in .043 mounting hole

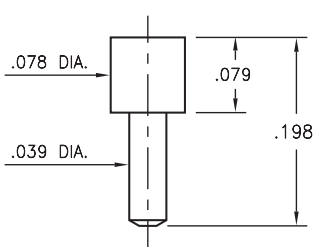

1980

1980-0-00-00-XX-00-03-0

Surface mount, Target Connector
Also available on carrier tape: 1,450 parts per 13" reel. Order as: 319-10-1XX-40-080001

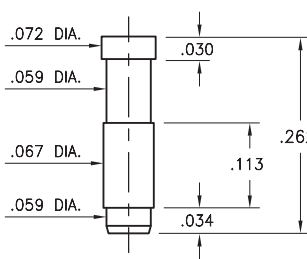

2820

2820-0-00-XX-00-00-03-0

Also available in HSMT connector series:
328-XX-1XX-40-020001
1,450 parts per 13" reel
See page 87.4 for Tape & Reel details

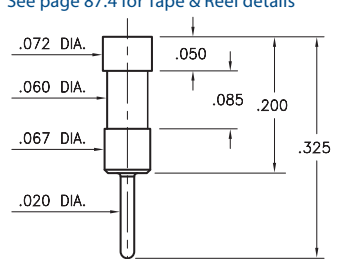

SPECIFICATIONS:

Pin Material: Brass Alloy 360, 1/2 Hard
(Except swage pins which are annealed)

Dimensions: Inches

Tolerances On: Lengths: ±.005
Diameters: ±.002
Angles: ± 2°



ORDER CODE: XXXX - X - 0X - XX - 00 - 00 - XX - 0

BASIC PART #

SPECIFY PIN FINISH:

- 01 200 μ" TIN/LEAD OVER NICKEL
- ◆ 80 200 μ" TIN OVER NICKEL (RoHS)
- ◆ 15 10 μ" GOLD OVER NICKEL (RoHS)
- ◆ 21 20 μ" GOLD OVER NICKEL (RoHS)
- ◆ 34 50 μ" GOLD OVER NICKEL (RoHS)

MALE PCB PINS

PRINTED CIRCUIT PINS

8685/9036

XXXX-0-00-XX-00-00-03-0

Press-fit in .033 mounting hole
Pin material is Phosphor Bronze 544 (B2)

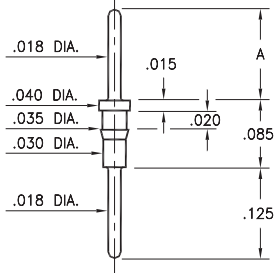

Basic Part Number	Length A
8685-0	.125
9036-0	.175

3790

3790-0-00-XX-00-00-03-0

Press-fit in .057 mounting hole

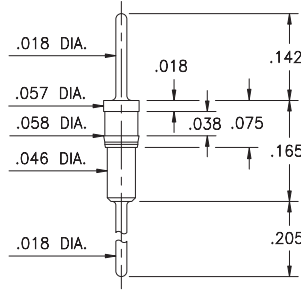

3796

3796-0-00-XX-00-00-03-0

Press-fit in .057 mounting hole

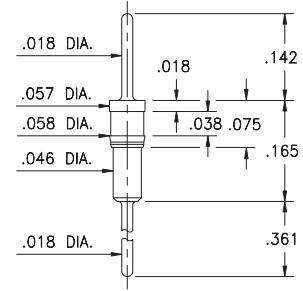

9051

9051-0-00-XX-00-00-03-0

Press-fit in .057 mounting hole

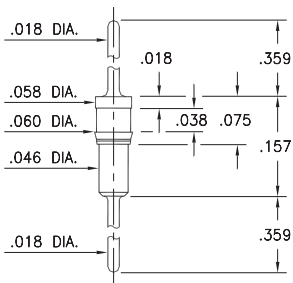

6109

6109-0-00-XX-00-00-03-0

Press-fit in .026 mounting hole

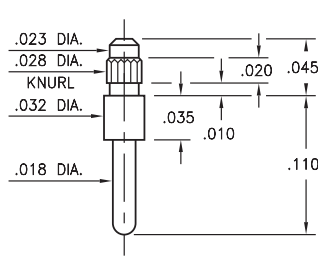

9159

9159-0-00-XX-00-00-03-0

Press-fit in .026 mounting hole

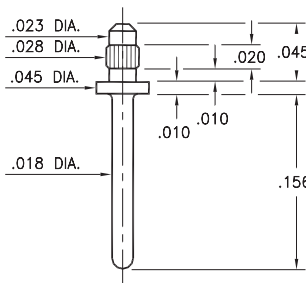

4366

4366-0-00-XX-00-00-03-0

Hex press-fit in .034 plated through-hole

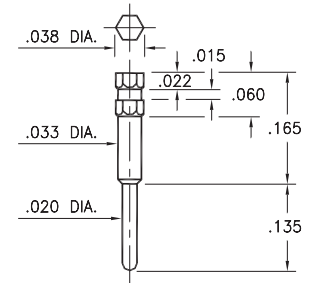

7979/8979

X979-0-00-XX-00-00-03-0

Hex press-fit in .074 plated through-hole

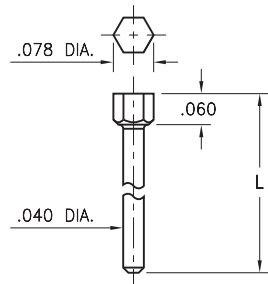

Basic Part Number	Length L
8979-0	.381
7979-0	.693

4397

4397-0-00-XX-00-00-03-0

Press-fit in .049 mounting hole

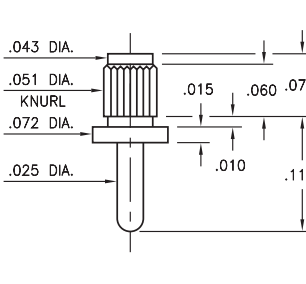

5344

5344-0-00-XX-00-00-03-0

Press-fit in .082 mounting hole

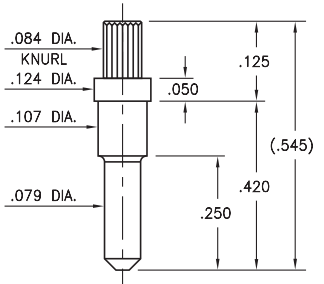

SPECIFICATIONS:

Pin Material: Brass Alloy 360, 1/2 Hard
(Except where noted)

Dimensions: Inches

Tolerances On: Lengths: ±.005
Diameters: ±.002
Angles: ±2°



ORDER CODE: XXXX - X - 0X - XX - 00 - 00 - XX - 0

BASIC PART #

SPECIFY PIN FINISH:

- 01 200 μ" TIN/LEAD OVER NICKEL
- ◆ 80 200 μ" TIN OVER NICKEL (RoHS)
- ◆ 15 10 μ" GOLD OVER NICKEL (RoHS)
- ◆ 21 20 μ" GOLD OVER NICKEL (RoHS)
- ◆ 34 50 μ" GOLD OVER NICKEL (RoHS)



MALE PCB PINS

PRINTED CIRCUIT PINS

X435

X435-X-05-XX-00-00-03-0

Square press-fit in .022 plated through-hole

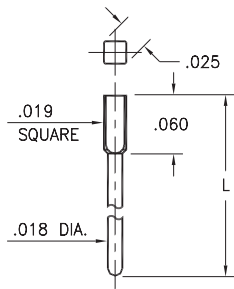

Basic Part Number	Length L
5435-0	.303
5435-1	.200
5435-2	.413
6435-0	.280

8969

8969-0-05-XX-00-00-03-0

Square press-fit in .023 plated through-hole
(Use .7mm drill prior to plating)

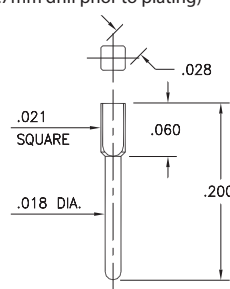

5835

5835-0-05-XX-00-00-03-0

Square press-fit in .032 plated through-hole

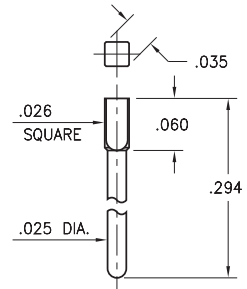

1267

1267-0-00-XX-00-00-03-0

Press-fit in .035 mounting hole

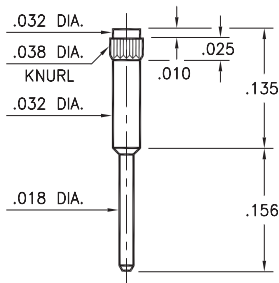

7827

7827-0-00-XX-00-00-03-0

Press-fit in .035 mounting hole

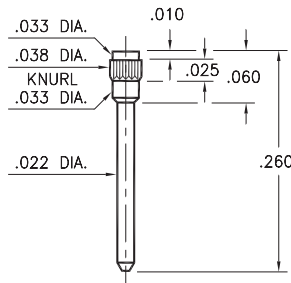

5145

5145-0-00-XX-00-00-03-0

Press-fit in .026 mounting hole

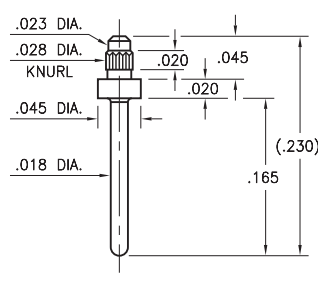

8797

8797-0-00-XX-00-00-03-0

Press-fit in .026 mounting hole

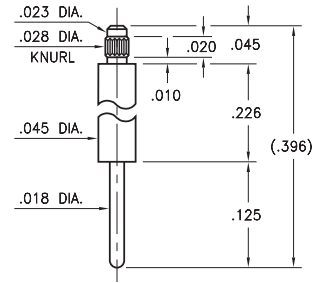

3155/5155

X155-0-00-XX-00-00-03-0

Press-fit in .026 mounting hole
Pin material is Phosphor Bronze 544 (B2)

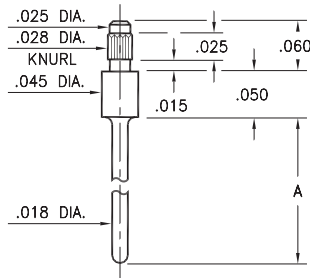

Basic Part Number	Length A
3155-0	.180
5155-0	.130

6061

6061-0-00-XX-00-00-03-0

Press-fit in .040 mounting hole

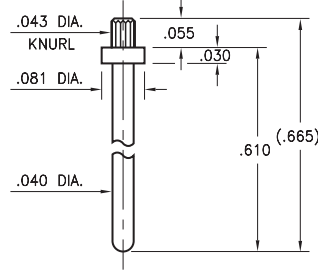

4526

4526-0-00-XX-00-00-03-0

Press-fit in .040 mounting hole

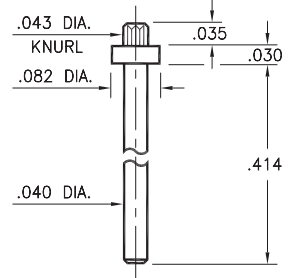

SPECIFICATIONS:

Pin Material: Brass Alloy 360, 1/2 Hard
(Except where noted)

Dimensions: Inches

Tolerances On: Lengths: ±.005
Diameters: ±.002
Angles: ± 2°



ORDER CODE: XXXX - X - 0X - XX - 00 - 00 - XX - 0

BASIC PART #

SPECIFY PIN FINISH:

- 01** 200 μ" TIN/LEAD OVER NICKEL
- 80** 200 μ" TIN OVER NICKEL (RoHS)
- 15** 10 μ" GOLD OVER NICKEL (RoHS)
- 21** 20 μ" GOLD OVER NICKEL (RoHS)
- 34** 50 μ" GOLD OVER NICKEL (RoHS)



MALE PCB PINS

PRINTED CIRCUIT PINS

1067

1067-X-00-XX-00-00-03-0

Press-fit in .042/.055 mounting hole

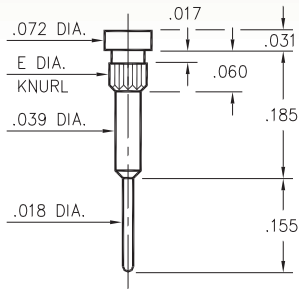

Basic Part Number	Knurl Dia. E	Mounting Hole
1067-1	.058	.055
1067-2	.045	.042

3158

3158-0-00-XX-00-00-03-0

Press-fit in .023 mounting hole

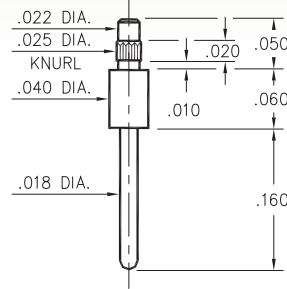

9000

9000-0-00-XX-00-00-03-0

Pentagonal press-fit in .025 plated through-hole

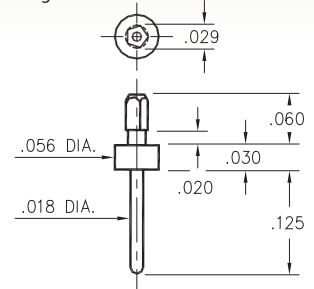

3157

3157-0-00-XX-00-00-03-0

Press-fit in .026 mounting hole

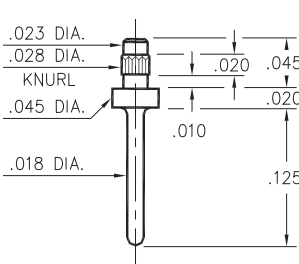

0915

0915-0-00-XX-00-00-03-0

Press-fit in .057 mounting hole

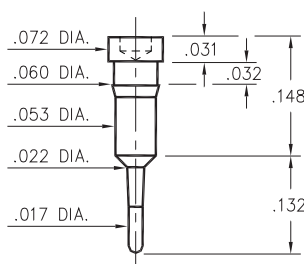

3154

3154-0-00-XX-00-00-03-0

Press-fit in .026 mounting hole
Pin material is Phosphor Bronze 544 (B2)

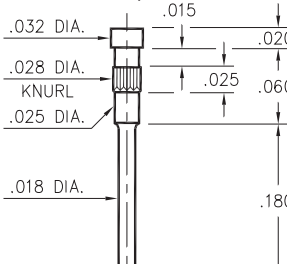

0542

0542-0-00-XX-00-00-03-0

Hex press-fit in .039 plated through-hole

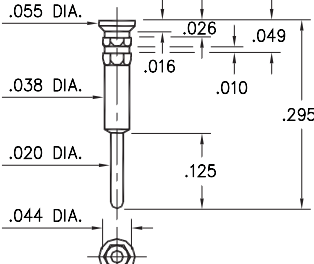

0522

0522-0-00-XX-00-00-03-0

Pentagonal press-fit in .042 plated through-hole

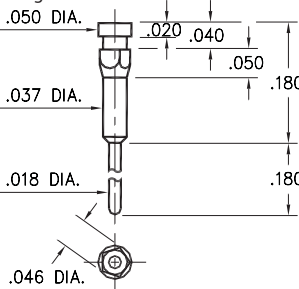

0952

0952-0-00-XX-00-00-03-0

Press-fit in .056 mounting hole

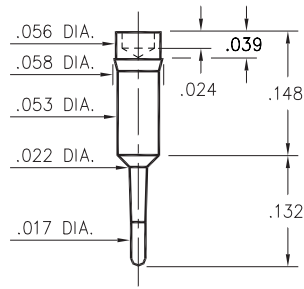

0257

0257-0-00-XX-00-00-03-0

Press-fit in .059 mounting hole

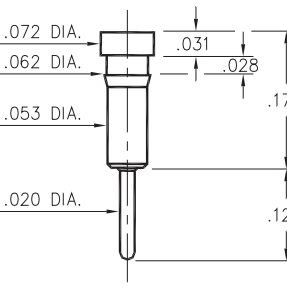

8940

8940-0-00-XX-00-00-03-0

Press-fit in .057 mounting hole

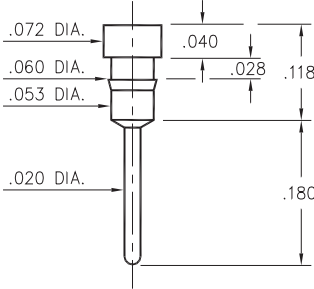

SPECIFICATIONS:

Pin Material: Brass Alloy 360, 1/2 Hard
(Except where noted)

Dimensions: Inches

Tolerances On: Lengths: ±.005
Diameters: ±.002
Angles: ± 2°



ORDER CODE: XXXX - X - 00 - XX - 00 - 00 - 03 - 0

BASIC PART #

SPECIFY PIN FINISH:

- 01 200 μ" TIN/LEAD OVER NICKEL
- ◆ 80 200 μ" TIN OVER NICKEL (RoHS)
- ◆ 15 10 μ" GOLD OVER NICKEL (RoHS)
- ◆ 21 20 μ" GOLD OVER NICKEL (RoHS)
- ◆ 34 50 μ" GOLD OVER NICKEL (RoHS)



MALE PCB PINS

PRINTED CIRCUIT PINS

0504/0505

050X-0-00-XX-00-00-03-0

Press-fit in .057 mounting hole

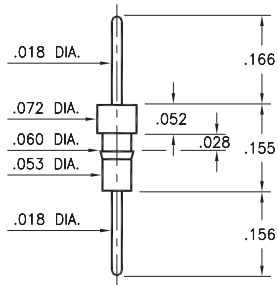

Basic Part Number	Pin Material
0504-0	Phosphor Bronze 544
0505-0	Brass 360

5510/5511

551X-0-00-XX-00-00-03-0

Press-fit in .057 mounting hole

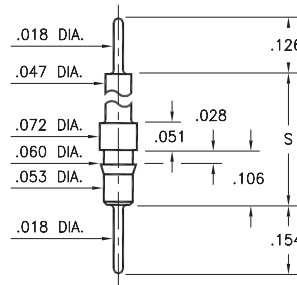

Basic Part Number	Standoff Height S
5510-0	.331
5511-0	.606

4259

4259-X-00-XX-00-00-03-0

Press-fit in .057 mounting hole

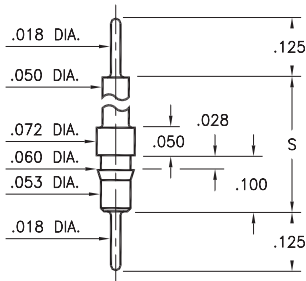

Basic Part Number	Standoff Height S
4259-1	.210
4259-2	.335
4259-3	.585
4259-4	.835

X516

X516-0-00-XX-00-00-03-0

Press-fit in .057 mounting hole

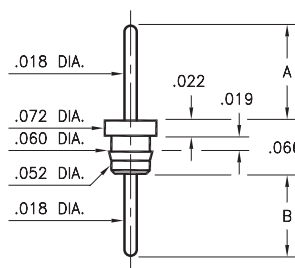

Basic Part Number	Pin Length A	Pin Length B
3516-0	.125	.108
4516-0	.135	.118

8859

8859-0-00-XX-00-00-03-0

Press-fit in .056 mounting hole

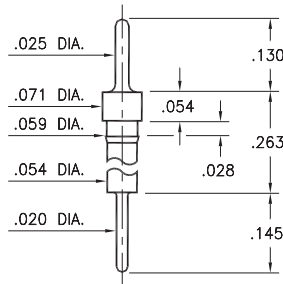

6585

6585-0-00-XX-00-00-03-0

Press-fit in .057 mounting hole
Pin material is Phosphor Bronze 544 (B2)

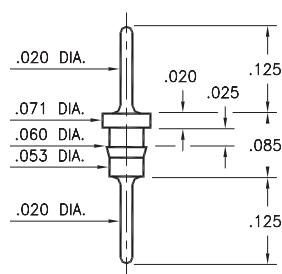

3404

3404-0-00-XX-00-00-03-0

Press-fit in .057 mounting hole

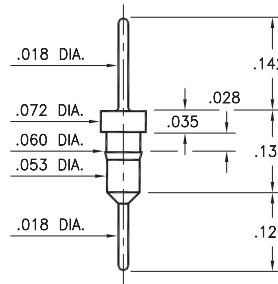

9218

9218-0-00-XX-00-00-03-0

Press-fit in .057 mounting hole

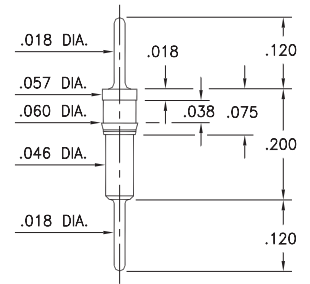

SPECIFICATIONS:

Pin Material: Brass Alloy 360, 1/2 Hard
(Except where noted)

Dimensions: Inches

Tolerances On: Lengths: $\pm .005$
Diameters: $\pm .002$
Angles: $\pm 2^\circ$



ORDER CODE: XXXX - X - 00 - XX - 00 - 00 - 03 - 0

BASIC PART #

SPECIFY PIN FINISH:

- 01 200 μ " TIN/LEAD OVER NICKEL
- ◆ 80 200 μ " TIN OVER NICKEL (RoHS)
- ◆ 15 10 μ " GOLD OVER NICKEL (RoHS)
- ◆ 21 20 μ " GOLD OVER NICKEL (RoHS)
- ◆ 34 50 μ " GOLD OVER NICKEL (RoHS)



MALE PCB PINS

PRINTED CIRCUIT PINS

1752/6458

XXXX-0-00-XX-00-00-03-0

Press-fit in .057 mounting hole

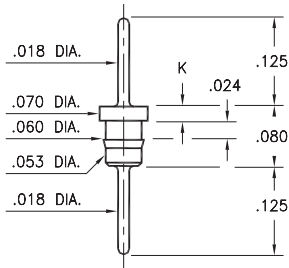

Basic Part Number	Length K
1752-0	.020
6458-0	.035

3413/8404

X4XX-0-00-XX-00-00-03-0

Press-fit in .057 mounting hole

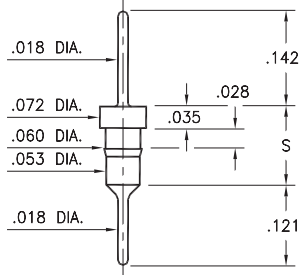

Basic Part Number	Length S
3413-0	.118
8404-0	.131

9075

9075-0-00-XX-00-00-03-0

Press-fit in .034 mounting hole

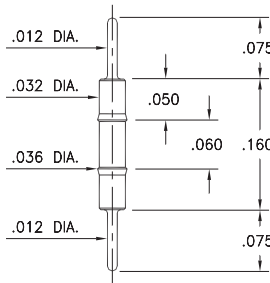

2617

2617-0-01-XX-00-00-03-0

Compliant press-fit in .040 ± .003 plated hole. For .060" → .100" thick board

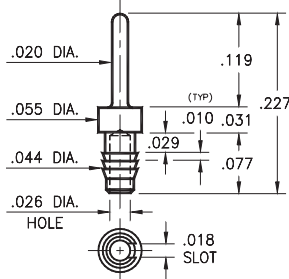

5607

5607-0-01-XX-00-00-03-0

Compliant press-fit in .040 ± .003 plated hole. For .060" → .100" thick board

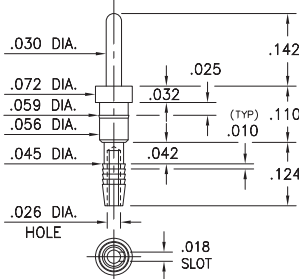

8995

8995-0-01-XX-00-00-03-0

Compliant press-fit in .040 ± .003 plated hole. For .060" → .100" thick board

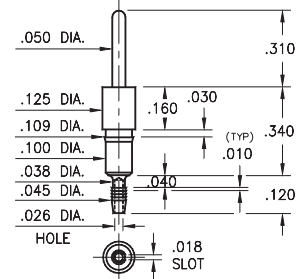

9218

9218-0-00-XX-00-00-03-0

Press-fit in .057 mounting hole

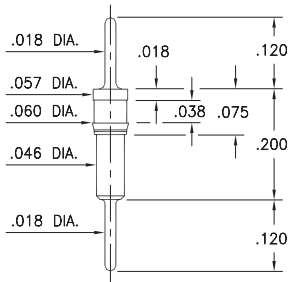

5065

5065-0-00-26-00-00-03-0

Press-fit in .037 mounting hole

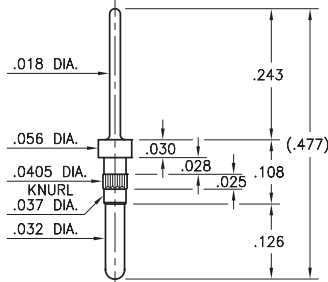

SPECIFICATIONS:

Pin Material: Brass Alloy 360, 1/2 Hard
(Except where noted)

Dimensions: Inches

Tolerances On: Lengths: ± .005
Diameters: ± .002
Angles: ± 2°



ORDER CODE: XXXX - X - 0X - XX - 00 - 00 - 03 - 0

BASIC PART #

SPECIFY PIN FINISH:

- 01 200 μ" TIN/LEAD OVER NICKEL
- ◆ 80 200 μ" TIN OVER NICKEL (RoHS)
- ◆ 15 10 μ" GOLD OVER NICKEL (RoHS)
- ◆ 21 20 μ" GOLD OVER NICKEL (RoHS)
- ◆ 34 50 μ" GOLD OVER NICKEL (RoHS)



MALE PCB PINS

PRINTED CIRCUIT PINS

3409

3409-X-00-XX-00-00-03-0

Press-fit in .057 mounting hole

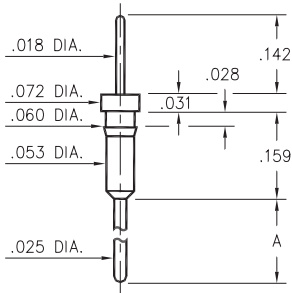

Basic Part Number	Pin Length A
3409-1	.210
3409-2	.420

0315

0315-0-00-XX-00-00-03-0

Press-fit in .057 mounting hole
Pin material is Phosphor Bronze 544 (B2)

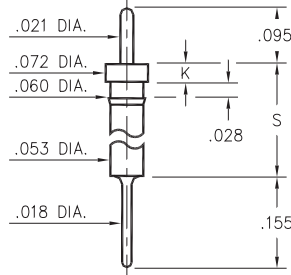

Basic Part Number	Head Height K	Standoff Height S
0315-0	.030	.190
0315-1	.040	.430

5503/5509

550X-X-00-XX-00-00-03-0

Press-fit in .057 mounting hole

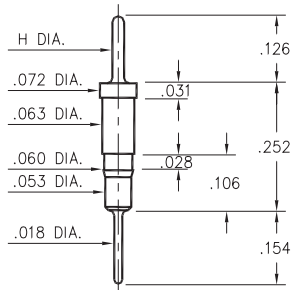

Basic Part Number	Pin Diameter H
5503-0	.025
5509-0	.018

5504/5505

550X-0-00-XX-00-00-03-0

Press-fit in .057 mounting hole

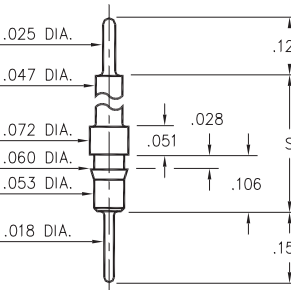

Basic Part Number	Standoff Height S
5504-0	.331
5505-0	.606

3406

3406-0-00-XX-00-00-03-0

Press-fit in .057 mounting hole

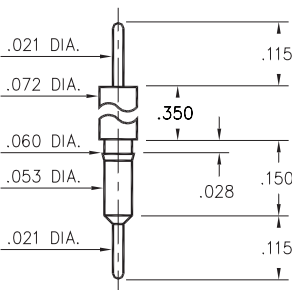

5011

5011-0-00-XX-00-00-03-0

Press-fit in .057 mounting hole

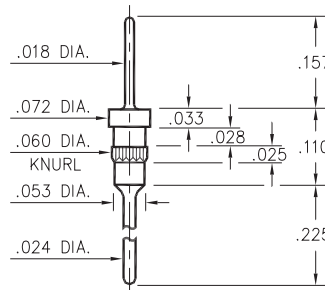

5113

5113-0-00-XX-00-00-03-0

Press-fit in .057 mounting hole

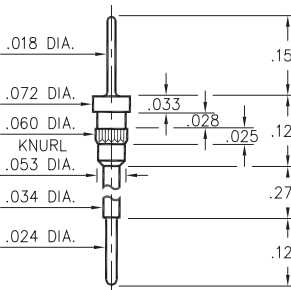

3900

3900-0-00-15-00-00-03-0

Press-fit in .057 mounting hole

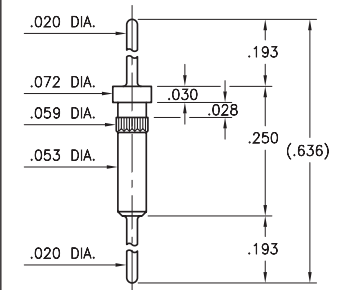

SPECIFICATIONS:

Pin Material: Brass Alloy 360, 1/2 Hard
(Except where noted)

Dimensions: Inches

Tolerances On: Lengths: ±.005
Diameters: ±.002
Angles: ±2°



ORDER CODE: XXXX - X - 00 - XX - 00 - 00 - 03 - 0

BASIC PART #

SPECIFY PIN FINISH:

- 01 200 μ" TIN/LEAD OVER NICKEL
- ◆ 80 200 μ" TIN OVER NICKEL (RoHS)
- ◆ 15 10 μ" GOLD OVER NICKEL (RoHS)
- ◆ 21 20 μ" GOLD OVER NICKEL (RoHS)
- ◆ 34 50 μ" GOLD OVER NICKEL (RoHS)



MALE PCB PINS

PRINTED CIRCUIT PINS

3400 ⇨ 3402/3405/3410

34XX-0-00-XX-00-00-03-0

Press-fit in .057 mounting hole

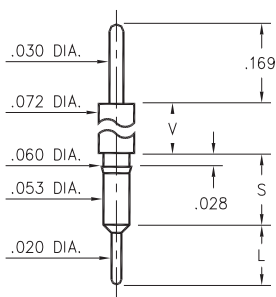

Basic Part Number	Shoulder Height V	Length S	Length L
3402-0	.052	.138	.121
3401-0	.100	.136	.125
3405-0	.169	.146	.115
3400-0	.461	.145	.115
3410-0	.934	.136	.124

3411

3411-X-00-XX-00-00-03-0

Press-fit in .057 mounting hole

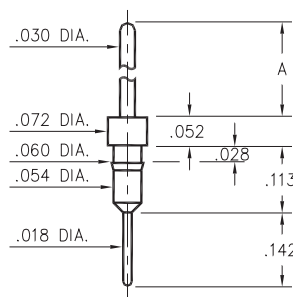

Basic Part Number	Pin Length A
3411-0	.417
3411-1	.217

0600

0600-0-05-XX-00-00-01-0

Solder mount .052 mounting hole

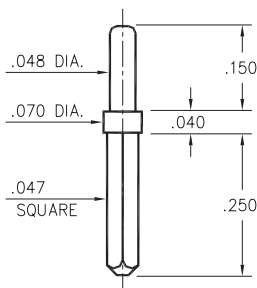

0290

0290-0-00-XX-00-00-03-0

Press-fit in .057 mounting hole

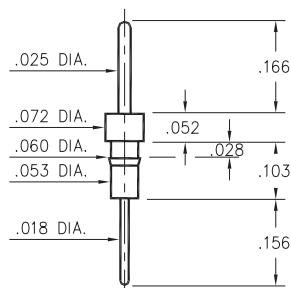

7007

7007-0-00-XX-00-00-03-0

Press-fit in .057 mounting hole

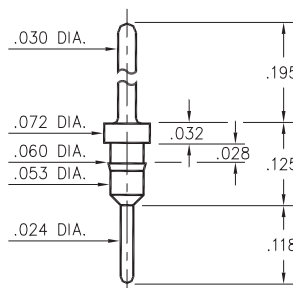

5016

5016-0-00-XX-00-00-03-0

Press-fit in .057 mounting hole

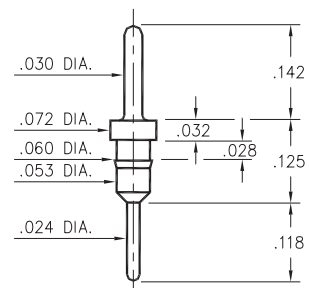

5005

5005-0-00-XX-00-00-03-0

Press-fit in .057 mounting hole

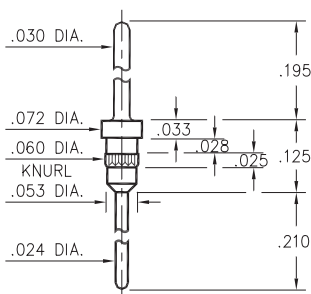

5107

5107-0-00-XX-00-00-03-0

Press-fit in .057 mounting hole

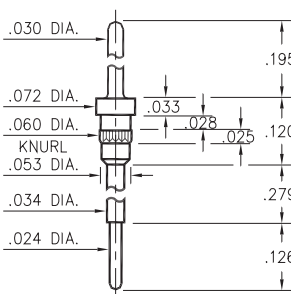

8919

8919-0-00-XX-00-00-03-0

Press-fit in .057 mounting hole

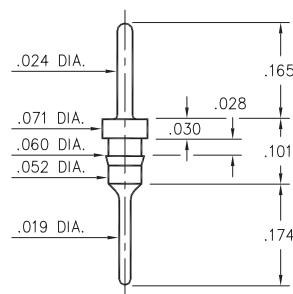

3077

3077-0-00-XX-00-00-03-0

Press-fit in .057 mounting hole

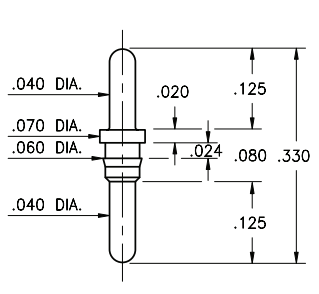

SPECIFICATIONS:

Pin Material: Brass Alloy 360, 1/2 Hard
(Except where noted)

Dimensions: Inches

Tolerances On: Lengths: ±.005
Diameters: ±.002
Angles: ± 2°



ORDER CODE: XXXX - X - 0X - XX - 00 - 00 - XX - 0

BASIC PART #

SPECIFY PIN FINISH:

- 01 200 μ" TIN/LEAD OVER NICKEL
- ◆ 80 200 μ" TIN OVER NICKEL (RoHS)
- ◆ 15 10 μ" GOLD OVER NICKEL (RoHS)
- ◆ 21 20 μ" GOLD OVER NICKEL (RoHS)
- ◆ 34 50 μ" GOLD OVER NICKEL (RoHS)



MALE PCB PINS

PRINTED CIRCUIT PINS

3408

3408-X-00-XX-00-00-03-0

Press-fit in .057 mounting hole

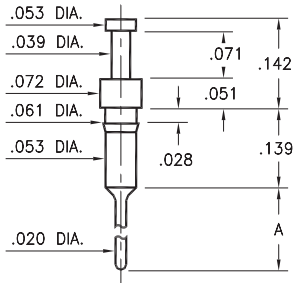

Basic Part Number	Pin Length A
3408-1	.121
3408-2	.181

0270/0282

02XX-0-01-XX-00-00-03-0

Press-fit in .057 mounting hole

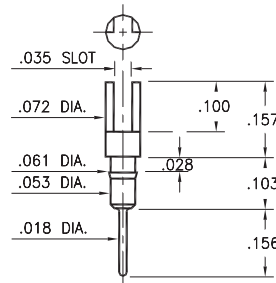

Basic Part Number	Pin Material
0270-0	Phosphor Bronze 544 Brass 360
0282-0	

0700

0700-0-00-XX-00-00-03-0

Press-fit in .057 mounting hole

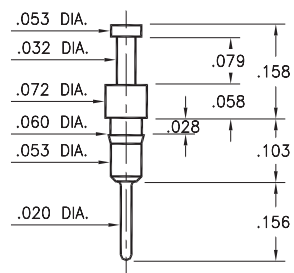

8006

8006-0-00-XX-00-00-03-0

Press-fit in .034 mounting hole

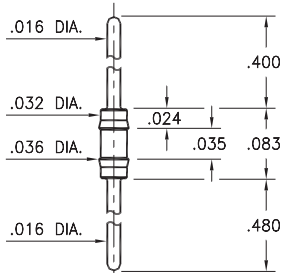

0265

0265-0-01-XX-00-00-03-0

Press-fit in .057 mounting hole

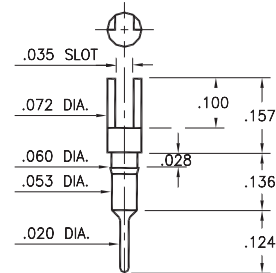

0272

0272-0-01-XX-00-00-03-0

Press-fit in .057 mounting hole

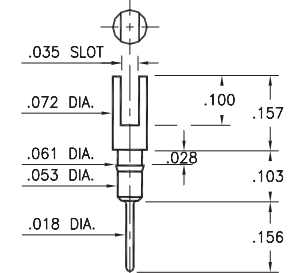

8000

8000-0-01-XX-00-00-03-0

Press-fit in .057 mounting hole

For wire sizes up to 22 AWG

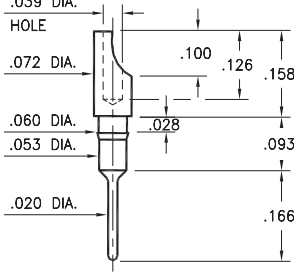

0275

0275-0-01-XX-00-00-03-0

Press-fit in .057 mounting hole

Pin material is Phosphor Bronze 544 (B2)

For wire sizes up to 22 AWG

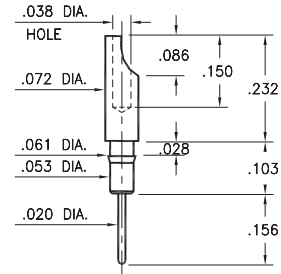

1107

1107-0-01-15-00-00-03-0

Press-fit in .057 mounting hole

For wire sizes up to 20 AWG

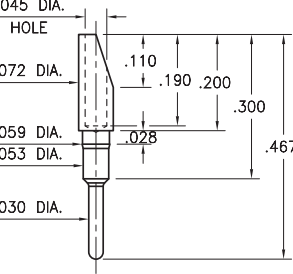

9976

9976-0-00-XX-00-00-03-0

Press-fit in .038 mounting hole

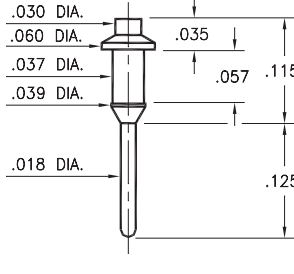

SPECIFICATIONS:

Pin Material: Brass Alloy 360, 1/2 Hard
(Except where noted)

Dimensions: Inches

Tolerances On: Lengths: ±.005
Diameters: ±.002
Angles: ±2°



ORDER CODE: XXXX - X - 0X - XX - 00 - 00 - XX - 0

BASIC PART #

SPECIFY PIN FINISH:

- 01 200 μ" TIN/LEAD OVER NICKEL
- ◆ 80 200 μ" TIN OVER NICKEL (RoHS)
- ◆ 15 10 μ" GOLD OVER NICKEL (RoHS)
- ◆ 21 20 μ" GOLD OVER NICKEL (RoHS)
- ◆ 34 50 μ" GOLD OVER NICKEL (RoHS)



MALE PCB PINS

PRINTED CIRCUIT PINS

3117

3117-X-00-XX-00-00-08-0

Swage mount in .035 hole

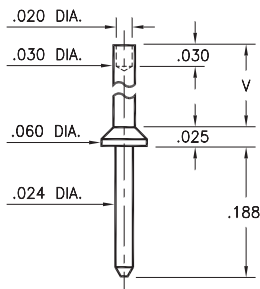

Basic Part Number	Board Thickness	Length V
3117-1	.031	.047
3117-2	.062	.078
3117-3	.094	.110
3117-4	.125	.141

3114/3115

311X-X-00-XX-00-00-08-0

Swage mount in .035 mounting hole

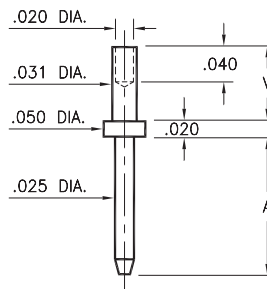

Basic Part Number	Board Thickness	Length A	Length V
3114-1	.031	.150	.051
3114-2	.062	.150	.082
3115-1	.031	.300	.051
3115-2	.062	.300	.082

3112

3112-X-00-XX-00-00-08-0

Swage mount in .043 hole

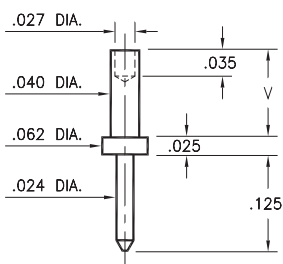

Basic Part Number	Board Thickness	Length V
3112-1	.031	.051
3112-2	.062	.082
3112-3	.094	.113

3118/3119

311X-X-00-XX-00-00-08-0

Swage mount in .035 hole

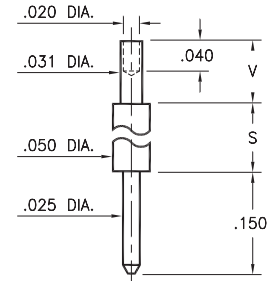

Basic Part Number	Board Thickness	Length S	Length V
3118-1	.031	.170	.051
3118-2	.062	.170	.082
3119-1	.031	.420	.051
3119-2	.062	.420	.082

3139

3139-0-00-XX-00-00-08-0

Wire crimp termination. Accepts wire sizes 24 AWG Max. / 28 AWG Min.

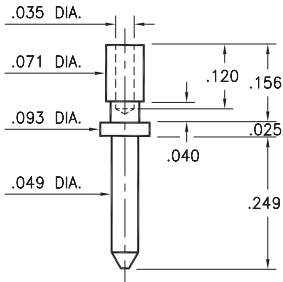

3602

3602-0-07-XX-00-00-08-0

Annealed
Wire crimp termination. Accepts wire sizes 20 AWG Max. / 24 AWG Min.

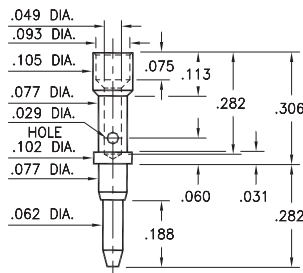

3603

3603-0-07-XX-00-00-08-0

Annealed
Wire crimp termination. Accepts wire sizes 20 AWG Max. / 24 AWG Min.

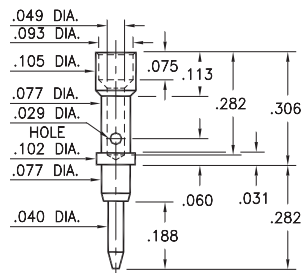

3131

3131-1-00-XX-00-00-08-0

Swage mount in .043 hole

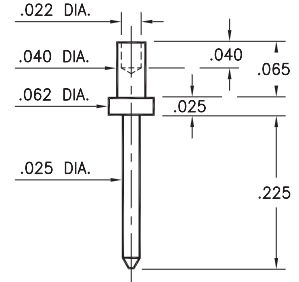

SPECIFICATIONS:

Pin Material: Brass Alloy 360, 1/2 Hard
(Except swage pins which are annealed)

Dimensions: Inches

Tolerances On: Lengths: ±.005
Diameters: ±.002
Angles: ±2°



ORDER CODE: XXXX - X - 0X - XX - 00 - 00 - XX - 0

BASIC PART #

SPECIFY PIN FINISH:

- 01 200 μ" TIN/LEAD OVER NICKEL
- ◆ 80 200 μ" TIN OVER NICKEL (RoHS)
- ◆ 15 10 μ" GOLD OVER NICKEL (RoHS)
- ◆ 21 20 μ" GOLD OVER NICKEL (RoHS)
- ◆ 34 50 μ" GOLD OVER NICKEL (RoHS)



MALE PCB PINS

PRINTED CIRCUIT PINS

0259/0286/1941

XXXX-0-00-XX-00-00-03-0

Press-fit in .057/.059 mounting hole
0286-0 is available on 16mm wide carrier tape; 2,500 parts per 13" reel.
See page 224.3 for Tape & Reel details

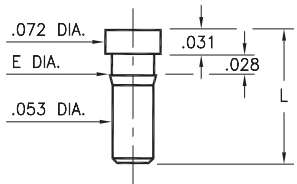

Basic Part Number	Length L	Barb Dia. E	Mounting Hole
0259-0	.173	.062	.059
0286-0	.115	.060	.057
*1941-0	.169	.058	.056

* Flat face Target contact

2956-0

2956-0-00-XX-00-00-03-0

Surface mount

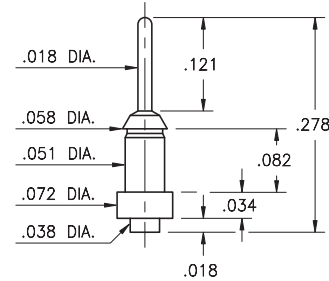

2956-1

2956-1-00-XX-00-00-03-0

Surface mount

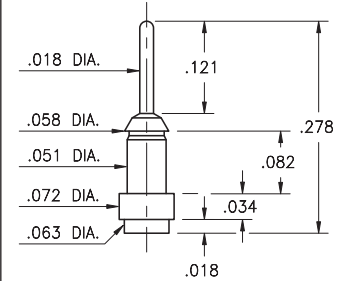

4956-1

4956-1-00-XX-00-00-33-0

Surface mount

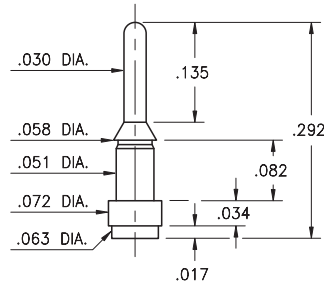

8876

8876-0-00-XX-00-00-03-0

Press-fit in .057 mounting hole

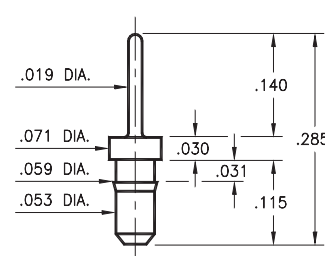

1938

1938-0-00-XX-00-00-03-0

Flat face Target contact, solder Tail

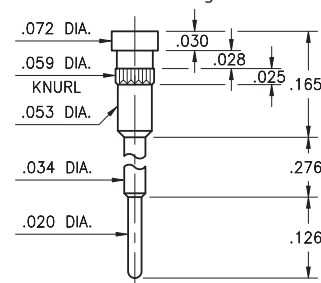

1940

1940-0-00-XX-00-00-03-0

Flat face Target contact, solder Tail

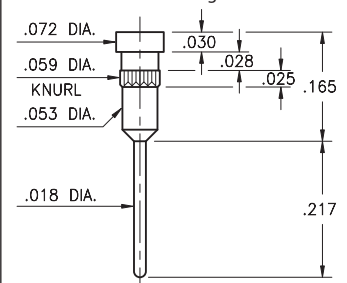

1942

1942-0-00-XX-00-00-03-0

Flat face Target contact, solder Tail
Press-fit in .056 mounting hole

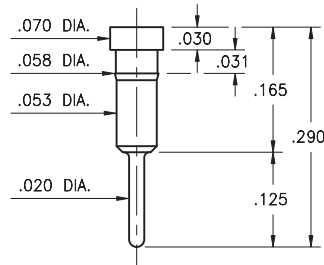

3024

3024-0-01-XX-00-00-03-0

Flat face Target contact, solder cup
Press-fit in .056 mounting hole
For wire sizes up to 22 AWG

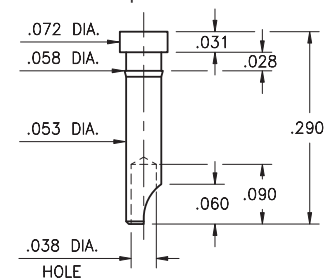

3000

3000-0-00-XX-00-00-03-0

Flat face Target contact, wire termination
Press-fit in .061 mounting hole. Accepts wire sizes 24 AWG Max. / 28 AWG Min.

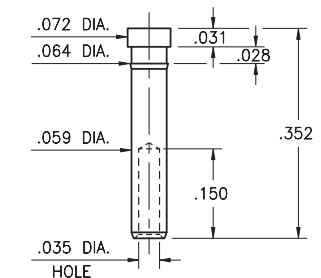

3080

3080-0-01-XX-00-00-03-0

Press-fit in .057 mounting hole
For wire sizes up to 22 AWG

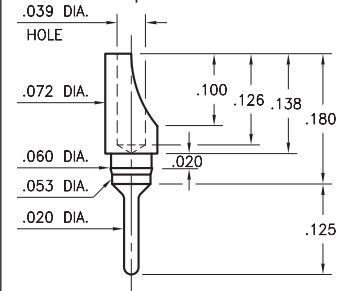

SPECIFICATIONS:

Pin Material: Brass Alloy 360, 1/2 Hard
(Except swage pins which are annealed)

Dimensions: Inches

Tolerances On: Lengths: ±.005
Diameters: ±.002
Angles: ±2°



ORDER CODE: XXXX - X - 0X - XX - 00 - 00 - XX - 0

BASIC PART #

SPECIFY PIN FINISH:

- 01 200 μ" TIN/LEAD OVER NICKEL
- ◆ 80 200 μ" TIN OVER NICKEL (RoHS)
- ◆ 15 10 μ" GOLD OVER NICKEL (RoHS)
- ◆ 21 20 μ" GOLD OVER NICKEL (RoHS)
- ◆ 34 50 μ" GOLD OVER NICKEL (RoHS)



MALE PCB PINS

PRINTED CIRCUIT PINS

3130/3134

31XX-X-00-XX-00-00-08-0

Swage mount in .052 hole

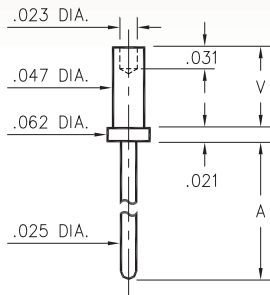

Basic Part Number	Board Thickness	Length A	Length V
3134-1	.031	.079	.051
3134-2	.062	.079	.082
3134-3	.094	.079	.113
3134-4	.125	.079	.145
3130-1	.031	.179	.051
3130-2	.062	.179	.082
3130-3	.094	.179	.113
3130-4	.125	.179	.145

3113

3113-X-00-XX-00-00-08-0

Swage mount in .062 hole

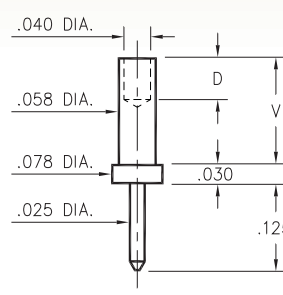

Basic Part Number	Board Thickness	Length V	Depth D
3113-1	.031	.062	.040
3113-2	.062	.094	.062
3113-3	.094	.125	.062
3113-4	.125	.156	.062

3151

3151-X-00-XX-00-00-08-0

Swage mount in .052 hole

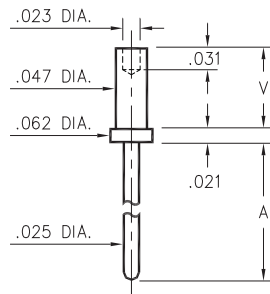

Basic Part Number	Board Thickness	Length A	Length V
3151-1	.031	.479	.051
3151-2	.062	.479	.082
3151-3	.094	.479	.113
3151-4	.125	.479	.145

3301 ⇨ 3304

330X-X-14-XX-00-00-08-0

Specify board thickness

Swage mount in .043 hole

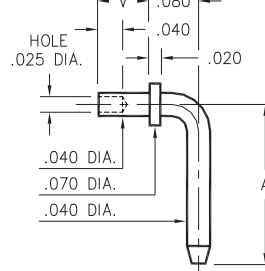

Basic Part Number	Pin Centers A
3301-X	.257
3302-X	.357
3303-X	.375
3304-X	.562

- X -	Board Thickness	Length V
1	.031	.051
2	.062	.082
3	.094	.113

3620

3620-X-32-XX-00-00-08-0

Board edge rivet mount.

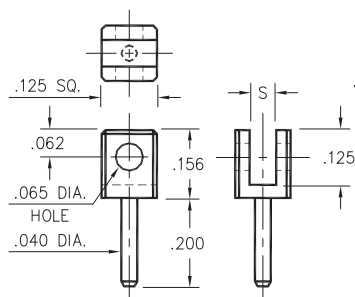

Basic Part Number	Board Thickness	Slot S
3620-1	.031	.047
3620-2	.062	.075

0940

0940-0-00-XX-00-00-03-0

Press-fit in .057 mounting hole

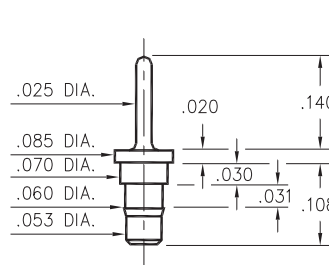

3621

3621-0-32-XX-00-00-08-0

Board edge rivet mount

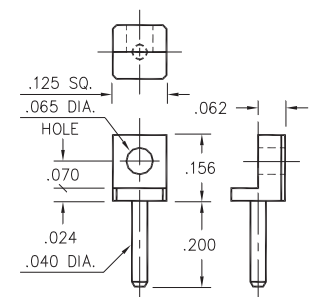

SPECIFICATIONS:

Pin Material: Brass Alloy 360, 1/2 Hard
(Except swage pins which are annealed)

Dimensions: Inches

Tolerances On: Lengths: ±.005
Diameters: ±.002
Angles: ±2°



ORDER CODE: XXXX - X - 0X - XX - 00 - 00 - XX - 0

BASIC PART #

SPECIFY PIN FINISH:

- 01 200 μ" TIN/LEAD OVER NICKEL
- ◆ 80 200 μ" TIN OVER NICKEL (RoHS)
- ◆ 15 10 μ" GOLD OVER NICKEL (RoHS)
- ◆ 21 20 μ" GOLD OVER NICKEL (RoHS)
- ◆ 34 50 μ" GOLD OVER NICKEL (RoHS)



MALE PCB PINS

PRINTED CIRCUIT PINS

3110/3111

311X-X-00-XX-00-00-08-0

Swage mount in .043 hole

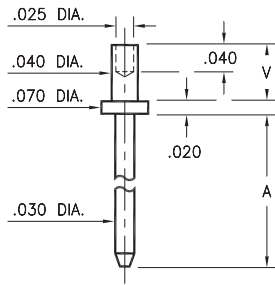

Basic Part Number	Board Thickness	Length A	Length V
3110-1	.031	.150	.051
3110-2	.062	.150	.082
3110-3	.094	.150	.113
3111-1	.031	.300	.051
3111-2	.062	.300	.082
3111-3	.094	.300	.113

3150

3150-X-00-XX-00-00-08-0

Swage mount in .043 mounting hole

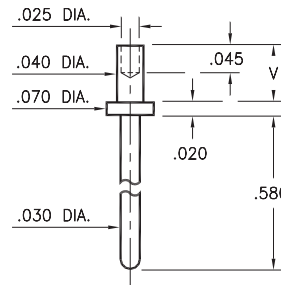

Basic Part Number	Board Thickness	Length V
3150-1	.031	.051
3150-2	.062	.082

3136/3137

313X-X-00-XX-00-00-08-0

Solder mount in .043 mounting hole

3137-1 is available on 16mm wide carrier tape: 580 parts per 13" reel.

See page 224.2 for Tape & Reel details

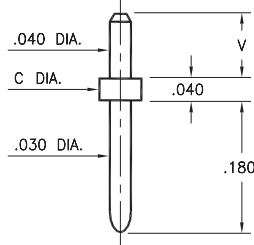

Basic Part Number	Board Thickness	Length V	Flange Dia. C
3136-1	.062	.082	
3136-2	.094	.110	.078
3136-3	.125	.145	
3137-1	.062	.082	
3137-2	.094	.110	.062
3137-3	.125	.145	
3137-4	.156	.185	

3148

3148-3-00-XX-00-00-08-0

Swage mount in .062 hole

For a .094 thick board

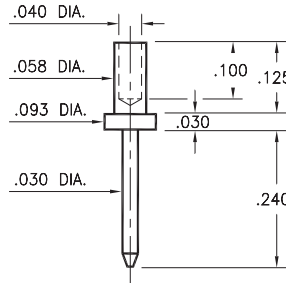

8815

8815-0-00-XX-00-00-03-0

Hex press-fit in .066 plated through-hole

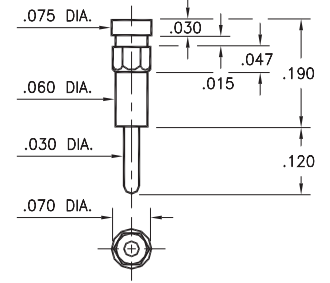

6821

6821-0-00-XX-00-00-08-0

Turret terminal pin

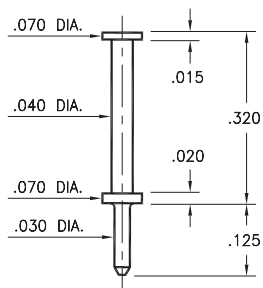

3132

3132-0-00-XX-00-00-08-0

Wire crimp termination, Annealed

Accepts wire sizes 22 AWG Max. / 24 AWG Min.

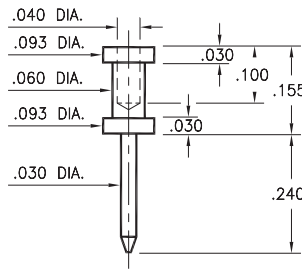

5601

5601-0-01-XX-00-00-03-0

Compliant press-fit in .040 ± .003 plated through-hole. For .060" → .100" thick board

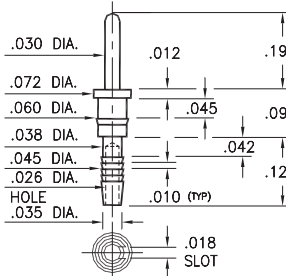

5602

5602-0-01-XX-00-00-03-0

Compliant press-fit in .040 ± .003 plated through-hole. For .090" → .130" thick board

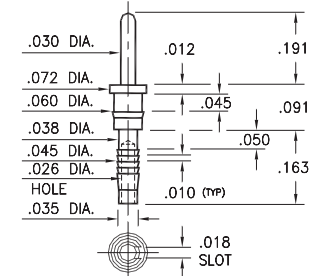

SPECIFICATIONS:

Pin Material: Brass Alloy 360, 1/2 Hard
(Except swage pins which are annealed)

Dimensions: Inches

Tolerances On: Lengths: ±.005
Diameters: ±.002
Angles: ±2°



ORDER CODE: XXXX - X - 0X - XX - 00 - 00 - XX - 0

BASIC PART #

SPECIFY PIN FINISH:

- 01 200 μ" TIN/LEAD OVER NICKEL
- ◆ 80 200 μ" TIN OVER NICKEL (RoHS)
- ◆ 15 10 μ" GOLD OVER NICKEL (RoHS)
- ◆ 21 20 μ" GOLD OVER NICKEL (RoHS)
- ◆ 34 50 μ" GOLD OVER NICKEL (RoHS)



MALE PCB PINS

PRINTED CIRCUIT PINS

3120

3120-X-00-XX-00-00-08-0

Swage mount in .034 hole

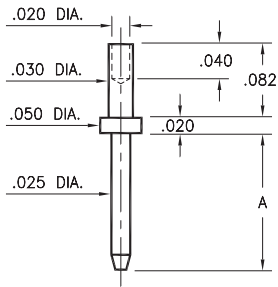

Basic Part Number	Pin Length A
3120-1	.205
3120-2	.250

3122 ⇔ 3153

31XX-X-00-XX-00-00-08-0

Swage mount in .043 hole

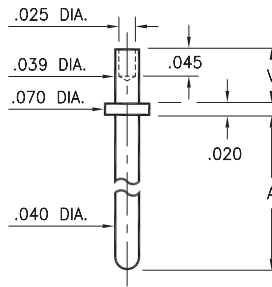

Basic Part Number	Pin Length A
3153-X	.180
3141-X	.230
3122-X	.280
3149-X	.380
3123-X	.580
3140-X	.780
3124-X	.880

-X-	Board Thickness	Length V
1	.031	.051
2	.062	.082

3101 ⇔ 3106

310X-X-00-XX-00-00-08-0

Swage mount in .043 hole

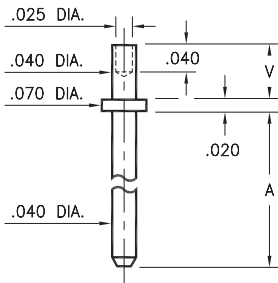

Basic Part Number	Pin Length A
3101-X	.150
3102-X	.188
3103-X	.300
3104-X	.500
3105-X	.750
3106-X	1.000

-X-	Board Thickness	Length V
1	.031	.051
2	.062	.082
3	.094	.113

3221 ⇔ 3223

322X-0-00-XX-00-00-08-0

Swage mount in .043 hole

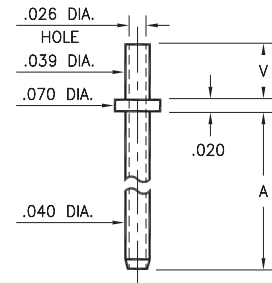

Basic Part Number	Pin Length A
3221-X	.100
3222-X	.150
3223-X	.300

-X-	Board Thickness	Length V
1	.031	.051
2	.062	.082
3	.094	.113

3125/3126

312X-X-00-XX-00-00-08-0

Swage mount in .043 hole

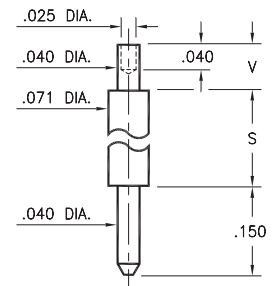

Basic Part Number	Pin Length S
3125-X	.170
3126-X	.420

-X-	Board Thickness	Length V
1	.031	.051
2	.062	.082
3	.094	.113

3116

3116-X-00-XX-00-00-08-0

Swage mount in .052 hole

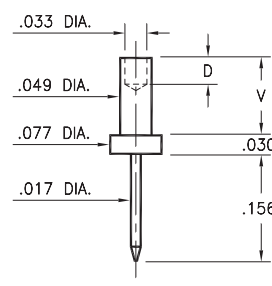

Basic Part Number	Board Thickness	Length V	Depth D
3116-1	.031	.051	.035
3116-2	.062	.082	.062
3116-3	.094	.113	.062
3116-4	.125	.145	.062

SPECIFICATIONS:

Pin Material: Brass Alloy 360, 1/2 Hard
(Except swage pins which are annealed)

Dimensions: Inches

Tolerances On: Lengths: ±.005
Diameters: ±.002
Angles: ± 2°



ORDER CODE: XXXX - X - 0X - XX - 00 - 00 - XX - 0

BASIC PART #

SPECIFY PIN FINISH:

- 01 200 μ" TIN/LEAD OVER NICKEL
- ◆ 80 200 μ" TIN OVER NICKEL (RoHS)
- ◆ 15 10 μ" GOLD OVER NICKEL (RoHS)
- ◆ 21 20 μ" GOLD OVER NICKEL (RoHS)
- ◆ 34 50 μ" GOLD OVER NICKEL (RoHS)



MALE PCB PINS

PRINTED CIRCUIT PINS

<p>4194 4194-0-00-XX-00-00-08-0 Wire crimp termination & press-fit in .036 hole Accepts wire sizes 30 AWG Max. / 36 AWG Min.</p>	<p>5556 5556-0-00-XX-00-00-38-0 Wire crimp termination. Accepts wire sizes 30 AWG Max. / 36 AWG Min.</p>	<p>3129 3129-1-00-XX-00-00-08-0 Swage mount in .035 hole For .031 thick board</p>	<p>3135 3135-1-00-XX-00-00-08-0 Swage mount in .040 hole For .031 thick board</p>
<p>3210 3210-2-00-XX-00-00-08-0 Swage mount in .031 hole For .062 thick board</p>	<p>3147 3147-3-00-XX-00-00-08-0 Swage mount in .043 hole For .094 thick board</p>	<p>4123 4123-0-00-XX-00-00-08-0 Swage mount in .044 hole For a .062 thick board</p>	<p>2231 2231-0-00-XX-00-00-08-0 Swage mount in .093 hole For a .031 thick board</p>
<p>4395 4395-0-00-XX-00-00-08-0 Swage mount in .093 hole For a .062 thick board</p>	<p>5233 5233-0-00-XX-00-00-08-0 Swage mount in .093 hole For a .062 thick board</p>	<p>6788 6788-0-00-XX-00-00-03-0 Annealed Wire crimp termination. Accepts wire sizes 20 AWG Max. / 24 AWG Min.</p>	<p>6331 6331-0-00-XX-00-00-08-0 Swage mount in .094 hole For a .125 thick board</p>

SPECIFICATIONS:

Pin Material: Brass Alloy 360, 1/2 Hard
(Except swage pins which are annealed)

Dimensions: Inches

Tolerances On: Lengths: $\pm .005$
Diameters: $\pm .002$
Angles: $\pm 2^\circ$



ORDER CODE: XXXX - X - 0X - **XX** - 00 - 00 - XX - 0

BASIC PART #

SPECIFY PIN FINISH:

- 01 200 μ " TIN/LEAD OVER NICKEL
- ◆ 80 200 μ " TIN OVER NICKEL (RoHS)
- ◆ 15 10 μ " GOLD OVER NICKEL (RoHS)
- ◆ 21 20 μ " GOLD OVER NICKEL (RoHS)
- ◆ 34 50 μ " GOLD OVER NICKEL (RoHS)

MALE PCB PINS

PRINTED CIRCUIT PINS

8600/8954/8955

8XXX-X-05-XX-00-00-03-0

Square press-fit in .043 plated through-hole

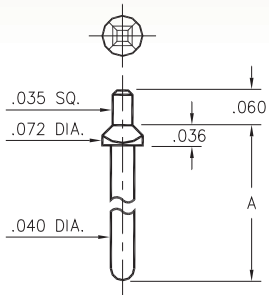

Basic Part Number	Pin Length A
8600-0	.400
8600-1	.850
8600-2	1.200
8954-0	.136
8955-0	.655

3159

3159-X-00-XX-00-00-08-0

Swage mount in .064 hole

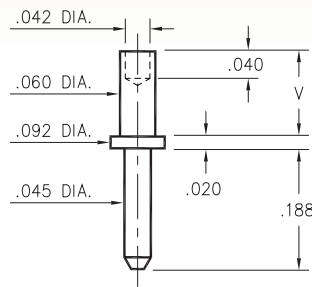

Basic Part Number	Board Thickness	Length V
3159-1	.031	.062
3159-2	.062	.094
3159-3	.094	.125
3159-4	.125	.156

8952

8952-0-05-XX-00-00-03-0

Square press-fit in .087 plated through-hole

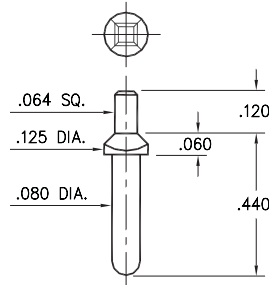

8953

8953-0-05-XX-00-00-03-0

Square press-fit in .047 plated through-hole

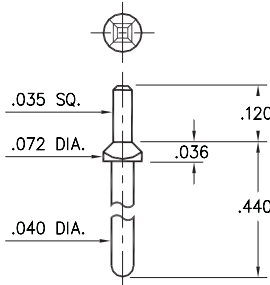

3230

3230-X-00-XX-00-00-08-0

Swage mount in .094 hole

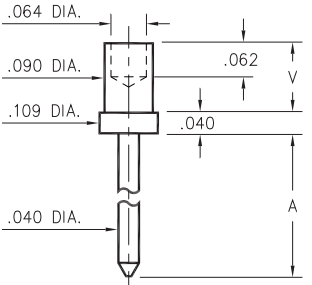

Basic Part Number	Board Thickness	Length A	Length V
3230-1	.031	.202	.065
3230-2	.062	.228	.095
3230-3	.094	.258	.125
3230-4	.125	.288	.155

3146

3146-2-00-XX-00-00-08-0

Swage mount in .076 hole

For a .062 thick board

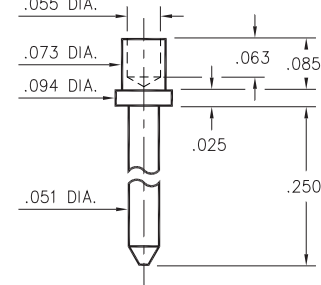

3142

3142-2-00-XX-00-00-08-0

Swage mount in .062 hole

For a .062 thick board

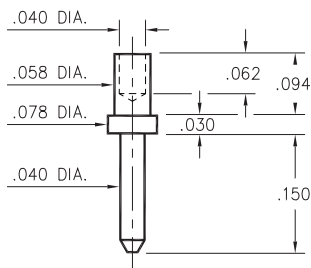

3232

3232-3-00-XX-00-00-08-0

Swage mount in .062 hole

For a .094 thick board

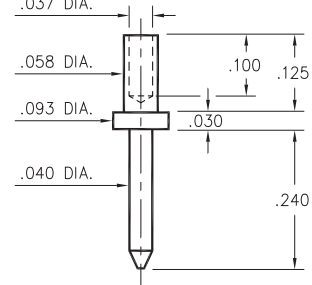

3145

3145-2-00-XX-00-00-08-0

Swage mount in .076 hole

For a .062 thick board

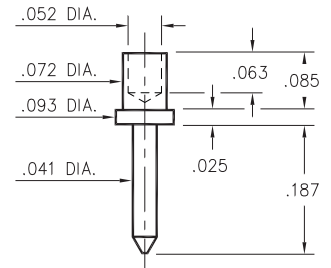

SPECIFICATIONS:

Pin Material: Brass Alloy 360, 1/2 Hard
(Except swage pins which are annealed)

Dimensions: Inches

Tolerances On: Lengths: $\pm .005$
Diameters: $\pm .002$
Angles: $\pm 2^\circ$



ORDER CODE: XXXX - X - 0X - XX - 00 - 00 - XX - 0

BASIC PART #

SPECIFY PIN FINISH:

- 01 200 μ " TIN/LEAD OVER NICKEL
- ◆ 80 200 μ " TIN OVER NICKEL (RoHS)
- ◆ 15 10 μ " GOLD OVER NICKEL (RoHS)
- ◆ 21 20 μ " GOLD OVER NICKEL (RoHS)
- ◆ 34 50 μ " GOLD OVER NICKEL (RoHS)



MALE PCB PINS

PRINTED CIRCUIT PINS

3231

3231-X-00-XX-00-00-08-0

Swage mount in .094 hole

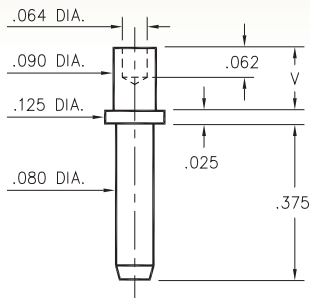

Basic Part Number	Board Thickness	Length V
3231-2	.062	.094
3231-3	.094	.125
3231-4	.125	.156

3609

3609-X-07-XX-00-00-08-0

Wire crimp termination. Accepts wire sizes 16 AWG Max. / 20 AWG Min.

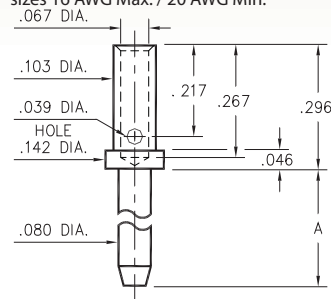

Basic Part Number	Pin Length A
3609-1	.200
3609-2	.375
3609-3	.500

3601

3601-X-07-XX-00-00-08-0

Wire crimp termination. Accepts wire sizes 20 AWG Max. / 24 AWG Min.

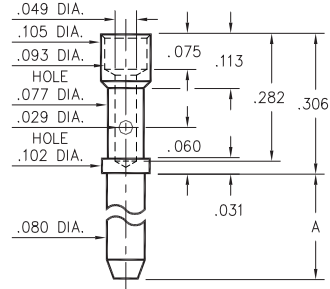

Basic Part Number	Pin Length A
3601-1	.200
3601-2	.375
3601-3	.500

3133/3138/3152

31XX-X-00-XX-00-00-08-0

Specify board thickness
Swage mount in .064 hole

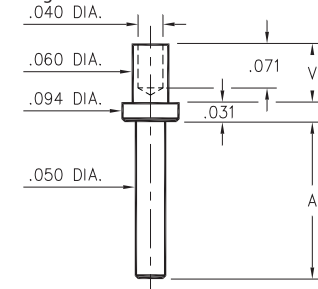

Basic Part Number	Pin Length A
3152-X	.094
3133-X	.219
3138-X	.282

- X -	Board Thickness	Length V
1	.031	.063
2	.062	.094
3	.094	.125
4	.125	.156

3144

3144-X-00-XX-00-00-08-0

Swage mount in .067 hole

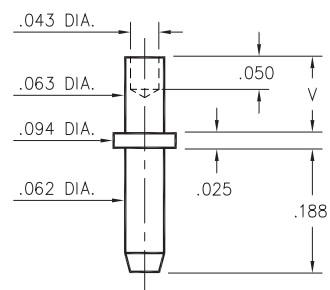

Basic Part Number	Board Thickness	Length V
3144-1	.031	.053
3144-2	.062	.084
3144-3	.094	.115

3233

3233-2-00-XX-00-00-08-0

Swage mount in .094 hole
For a .062 thick board

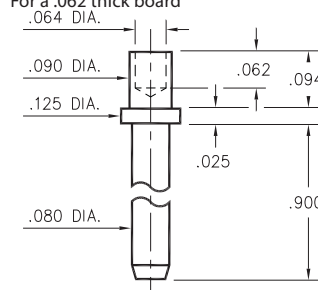

0520

0520-0-00-XX-00-00-03-0

Annealed
Wire crimp termination. Accepts wire sizes 20 AWG Max. / 24 AWG Min.

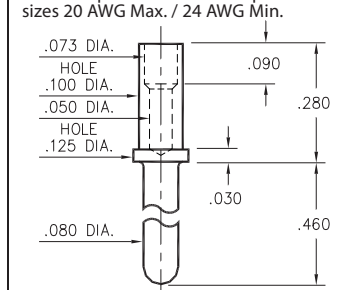

SPECIFICATIONS:

Pin Material: Brass Alloy 360, 1/2 Hard
(Except swage pins which are annealed)

Dimensions: Inches

Tolerances On: Lengths: ±.005
Diameters: ±.002
Angles: ±2°



ORDER CODE: XXXX - X - 0X - XX - 00 - 00 - XX - 0

BASIC PART #

SPECIFY PIN FINISH:

- 01 200 μ" TIN/LEAD OVER NICKEL
- ◆ 80 200 μ" TIN OVER NICKEL (RoHS)
- ◆ 15 10 μ" GOLD OVER NICKEL (RoHS)
- ◆ 21 20 μ" GOLD OVER NICKEL (RoHS)
- ◆ 34 50 μ" GOLD OVER NICKEL (RoHS)



MALE PCB PINS

PRINTED CIRCUIT PINS

1943

1943-0-00-15-00-00-03-0

Concave face Target contact, surface mount
Also available on 16mm wide carrier tape:
2,200 parts per 13" reel.
See page 224.3 for Tape & Reel details

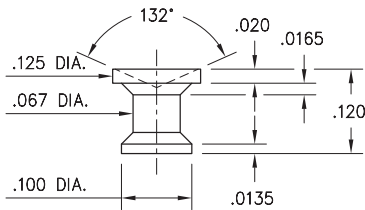

P.C.B. Layout

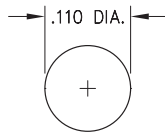

1944

1944-0-00-15-00-00-03-0

Flat face Target contact, surface mount
Also available on 16mm wide carrier tape:
2,200 parts per 13" reel.
See page 224.3 for Tape & Reel details

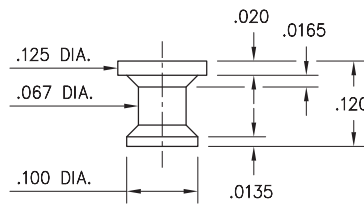

P.C.B. Layout

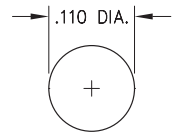

1945

1945-0-00-15-00-00-03-0

Concave face Target contact, solder Tail

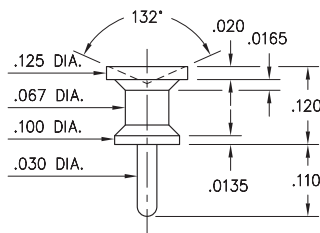

1946

1946-0-00-15-00-00-03-0

Flat face Target contact, solder Tail

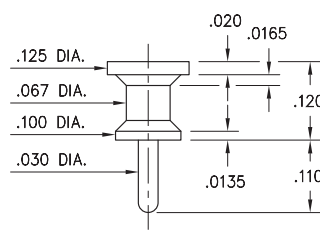

1947

1947-0-00-15-00-00-03-0

Concave face Target contact, surface mount
Press-fit in .056 mounting hole

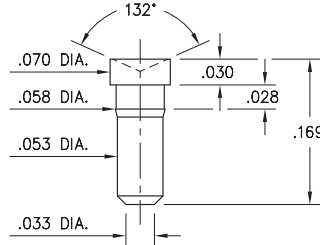

1948

1948-0-00-15-00-00-03-0

Concave face Target contact, Solder Tail
Press-fit in .056 mounting hole

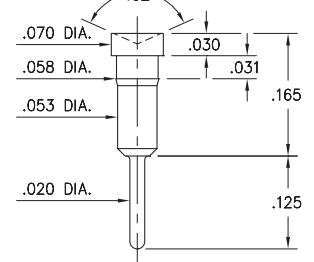

1949

1949-0-00-15-00-00-03-0

Flat face Target contact, surface mount
Press-fit in .056 mounting hole

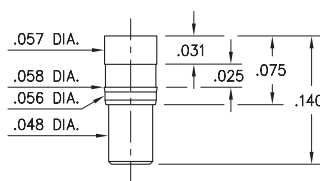

1950

1950-0-00-15-00-00-03-0

Concave face Target contact, surface mount
Press-fit in .056 mounting hole

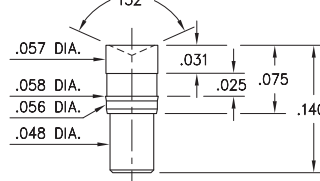

1951

1951-0-00-15-00-00-03-0

Flat face Target contact, Solder Tail
Press-fit in .056 mounting hole

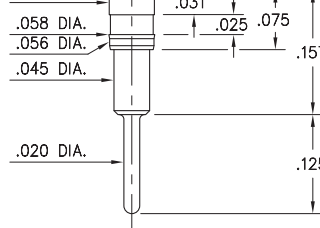

1952

1952-0-00-15-00-00-03-0

Concave face Target contact, solder Tail
Press-fit in .056 mounting hole

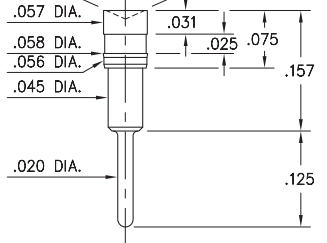

SPECIFICATIONS:

Pin Material: Brass Alloy 360, 1/2 Hard
(Except where noted)

Dimensions: Inches

Tolerances On: Lengths: $\pm .005$
Diameters: $\pm .002$
Angles: $\pm 2^\circ$



ORDER CODE: 194X - 0 - 00 - 15 - 00 - 00 - 03 - 0

BASIC PART #

SPECIFY PIN FINISH:

◆ 15 10 μ " GOLD OVER NICKEL (RoHS)



MALE PCB PINS

PRINTED CIRCUIT PINS

<p>1958 1958-0-00-15-00-00-03-0 Concave face Target contact, solder Tail Press-fit in .057 mounting hole</p>	<p>1960 1960-0-00-15-00-00-03-0 Concave face Target contact, solder Tail Press-fit in .057 mounting hole</p>	<p>1831 1831-1-00-15-00-00-03-0 Concave face Target contact, solder Tail Hex press-fit in .034 mounting hole</p>	<p>1931 1931-1-00-15-00-00-03-0 Flat face Target contact, solder Tail Hex press-fit in .034 mounting hole</p>
<p>1953 1953-0-00-XX-00-00-03-0 Flat face Target contact, surface mount Press-fit in .056 mounting hole</p>	<p>1954 1954-0-00-XX-00-00-03-0 Flat face Target contact, surface mount Press-fit in .056 mounting hole</p>	<p>1955 1955-0-00-15-00-00-03-0 Concave face Target contact, surface mount Press-fit in .056 mounting hole</p>	<p>1957 1957-0-00-15-00-00-03-0 Concave face Target contact, surface mount Press-fit in .056 mounting hole</p>
<p>1933 1933-0-00-XX-00-00-03-0 Flat face Target contact, solder Tail Press-fit in .034 mounting hole</p>	<p>1935 1935-0-00-XX-00-00-03-0 Flat face Target contact, surface mount Press-fit in .034 mounting hole</p>	<p>1934 1934-0-00-15-00-00-03-0 Concave face Target contact, solder Tail Press-fit in .034 mounting hole</p>	<p>1936 1936-0-00-15-00-00-03-0 Concave face Target contact, surface mount Press-fit in .034 mounting hole</p>

SPECIFICATIONS:

Pin Material: Brass Alloy 360, 1/2 Hard
(Except where noted)

Dimensions: Inches

Tolerances On: Lengths: ±.005
Diameters: ±.002
Angles: ± 2°



ORDER CODE: XXXX - 0 - 00 - XX - 00 - 00 - 03 - 0

BASIC PART # →

SPECIFY PIN FINISH:

- 01 200 μ" TIN/LEAD OVER NICKEL
- ◆ 80 200 μ" TIN OVER NICKEL (RoHS)
- ◆ 15 10 μ" GOLD OVER NICKEL (RoHS)
- ◆ 21 20 μ" GOLD OVER NICKEL (RoHS)
- ◆ 34 50 μ" GOLD OVER NICKEL (RoHS)



MALE PCB PINS

PRINTED CIRCUIT PINS

1140

1140-0-01-XX-00-00-03-0

Press-fit in .057 mounting hole
For wire sizes up to 20 AWG

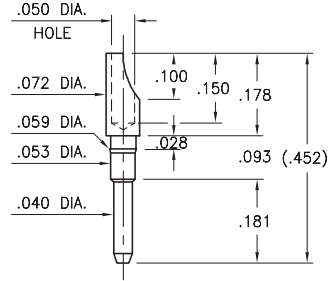

1160

1160-0-01-XX-00-00-03-0

Press-fit in .080 mounting hole
For wire sizes up to 16 AWG

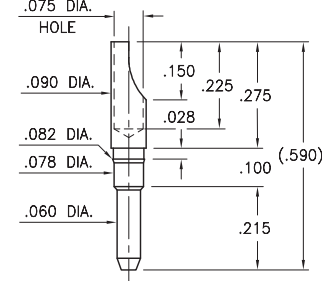

1178

1178-0-01-XX-00-00-03-0

Press-fit in .100 mounting hole
For wire sizes up to 14 AWG

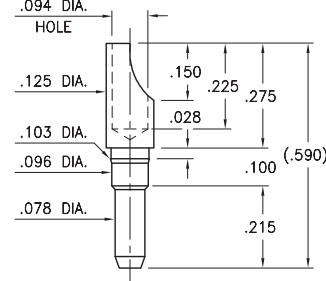

4658

4658-0-00-XX-00-00-08-0

Swage mount .043 mounting hole

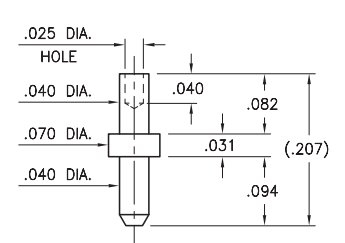

4275

4275-0-00-XX-00-00-08-0

Swage mount .043 mounting hole

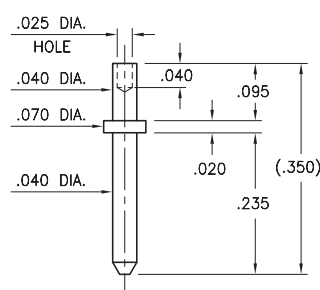

9103

9103-0-00-XX-00-00-08-0

Swage mount .043 mounting hole

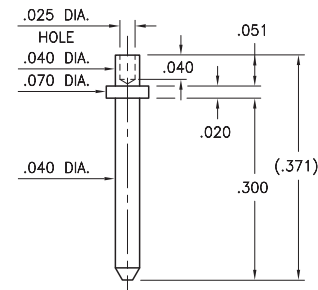

4357

4357-0-00-XX-00-00-03-0

Solder mount .064 mounting hole

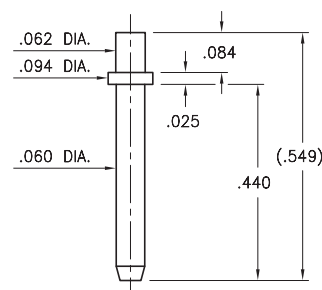

9242

9242-0-00-XX-00-00-08-0

Swage mount .094 mounting hole

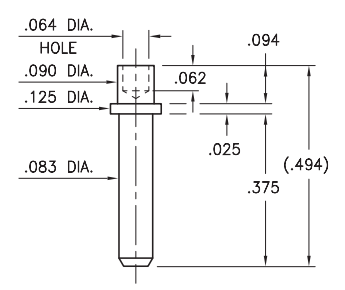

4639/4717

4XXX-0-00-XX-00-00-08-0

Swage mount .065 mounting hole

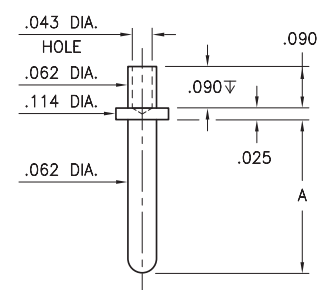

Basic Part Number	Pin Length A
4639-0	.432
4717-0	.332

3169

3169-0-61-15-00-00-03-0

Pins are mounted on a removable Kapton tape carrier at .100" pitch.
Packaged on continuous strip spools of 1,000 pins.
(Contact distributors for other order quantity options.)

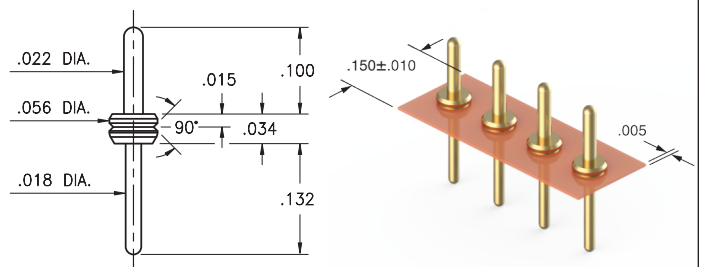

SPECIFICATIONS:

Pin Material: Brass Alloy 360, 1/2 Hard
(Except where noted)

Dimensions: Inches

Tolerances On: Lengths: ±.005
Diameters: ±.002
Angles: ±2°



ORDER CODE: XXXX - 0 - 00 - XX - 00 - 00 - 0X - 0

BASIC PART #

SPECIFY PIN FINISH:

- 01 200 μ" TIN/LEAD OVER NICKEL
- ◆ 80 200 μ" TIN OVER NICKEL (RoHS)
- ◆ 15 10 μ" GOLD OVER NICKEL (RoHS)
- ◆ 21 20 μ" GOLD OVER NICKEL (RoHS)
- ◆ 34 50 μ" GOLD OVER NICKEL (RoHS)



MALE PCB PINS

PRINTED CIRCUIT PINS

5920

5920-0-00-XX-00-00-03-0

Solderless press-fit pin for plated through-hole
Recommended drilled hole size: .086 (2,18mm)

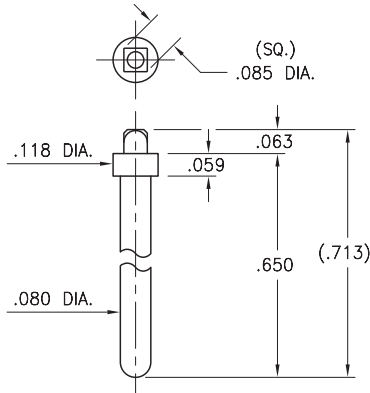

6025

6025-0-00-XX-00-00-03-0

Solderless press-fit pin for plated through-hole
Recommended drilled hole size: .068 (1,73mm)

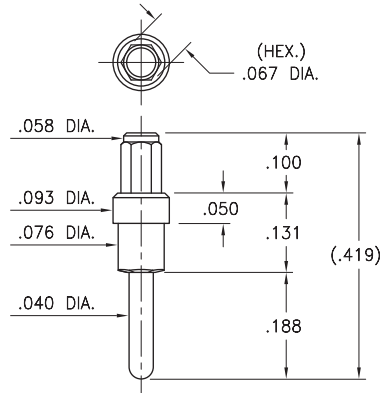

6035

6035-0-00-XX-00-00-03-0

Solderless press-fit pin for plated through-hole
Recommended drilled hole size: .068 (1,73mm)

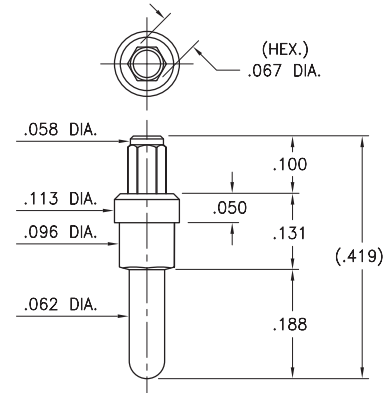

8237

8237-0-05-XX-00-00-03-0

Solderless press-fit pin for plated through-hole
Recommended drilled hole size: .092 (2,34mm)

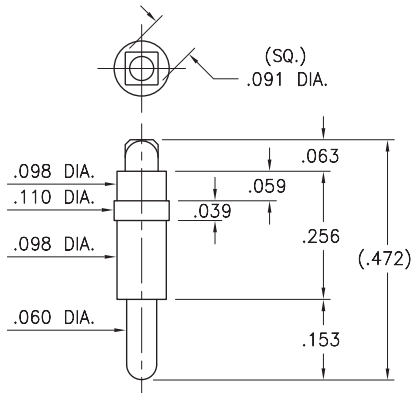

6834

6834-0-00-XX-00-00-03-0

Solderless press-fit pin for plated through-hole
Recommended drilled hole size: .0512 (1,3mm)

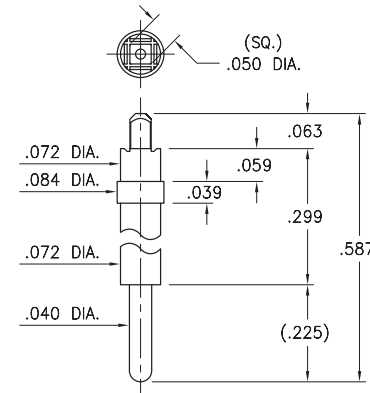

6835

6835-0-00-XX-00-00-44-0

Solderless press-fit pin for plated through-hole
Recommended drilled hole size: .092 (2,34mm)
* Pin Material: Tellurium Copper Alloy

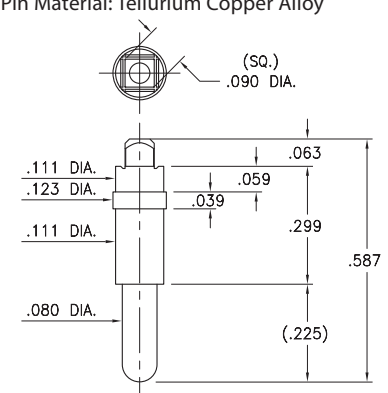

Recommended drilled hole sizes are prior to plating of the PCB and based on typical copper deposition of .5 - 1 oz. This results in a reduction of hole size by approximately .0015" - .003". Depending on surface plating, typical finished hole sizes are .003" - .005" smaller than drilled hole sizes. The finished hole size tolerance for press-fit applications should be specified as +/- .002"

SPECIFICATIONS:

Pin Material: Brass Alloy 360, 1/2 Hard
(Except where noted) *

Dimensions: Inches

Tolerances On: Lengths: ± .005
Diameters: ± .002
Angles: ± 2°



ORDER CODE: XXXX - 0 - 0X - XX - 00 - 00 - XX - 0

BASIC PART # →

SPECIFY PIN FINISH:

- 01 200 μ" TIN/LEAD OVER NICKEL
- ◆ 80 200 μ" TIN OVER NICKEL (RoHS)
- ◆ 15 10 μ" GOLD OVER NICKEL (RoHS)
- ◆ 21 20 μ" GOLD OVER NICKEL (RoHS)
- ◆ 34 50 μ" GOLD OVER NICKEL (RoHS)



MALE PCB PINS

PRINTED CIRCUIT PINS

<p>1959-0 1959-0-00-15-00-00-03-0 Flat face Target contact, surface mount Press-fit in .098 mounting hole</p>	<p>1959-1 1959-1-00-15-00-00-03-0 Concave face Target contact, surface mount Press-fit in .098 mounting hole</p>	<p>1969-0 1969-0-00-15-00-00-03-0 Flat face Target contact, solder Tail Press-fit in .098 mounting hole</p>	<p>1969-1 1969-1-00-15-00-00-03-0 Concave face Target contact, solder Tail Press-fit in .098 mounting hole</p>						
<p>1968-0 1968-0-01-15-00-00-03-0 Flat face Target contact, Press-fit in .097" mounting hole. For wire sizes up to 16AWG</p>	<p>1968-1 1968-1-01-15-00-00-03-0 Concave face Target contact, Press-fit in .097" mounting hole. For wire sizes up to 16AWG</p>	<p>3078 3078-X-00-15-00-00-03-0 Press-fit in .057 mounting hole For wire sizes up to 22 AWG</p> <table border="1" data-bbox="1218 924 1429 1092"> <thead> <tr> <th>Basic Part Number</th> <th>Pin Length A</th> </tr> </thead> <tbody> <tr> <td>3078-0</td> <td>.145</td> </tr> <tr> <td>3078-1</td> <td>.205</td> </tr> </tbody> </table>		Basic Part Number	Pin Length A	3078-0	.145	3078-1	.205
Basic Part Number	Pin Length A								
3078-0	.145								
3078-1	.205								
<p>3180 3180-2-01-XX-00-00-03-0 Press-fit in .055 mounting hole For wire sizes up to 22 AWG</p>	<p>0518 0518-0-01-XX-00-00-03-0 Press-fit in .059 mounting hole For wire sizes up to 22 AWG</p>	<p>4609 4609-0-07-XX-00-00-03-0 Wire crimp termination. Accepts wire sizes 18 AWG Max. / 20 AWG Min.</p>	<p>6618 6618-0-07-XX-00-00-03-0 Wire crimp termination. Accepts wire sizes 16 AWG Max. / 20 AWG Min.</p>						

SPECIFICATIONS:

Pin Material: Brass Alloy 360, 1/2 Hard
(Except where noted)

Dimensions: Inches

Tolerances On: Lengths: $\pm .005$
Diameters: $\pm .002$
Angles: $\pm 2^\circ$



ORDER CODE: XXXX - 0 - 00 - XX - 00 - 00 - 03 - 0

BASIC PART #

SPECIFY PIN FINISH:

- 01 200 μ " TIN/LEAD OVER NICKEL
- ◆ 80 200 μ " TIN OVER NICKEL (RoHS)
- ◆ 15 10 μ " GOLD OVER NICKEL (RoHS)
- ◆ 21 20 μ " GOLD OVER NICKEL (RoHS)
- ◆ 34 50 μ " GOLD OVER NICKEL (RoHS)



MALE PCB PINS

CRIMP PINS FOR 12-28 AWG WIRE

3922

3922-0-01-XX-00-00-08-0

Wire crimp termination. Accepts wire sizes 22 AWG Max. / 28 AWG Min.

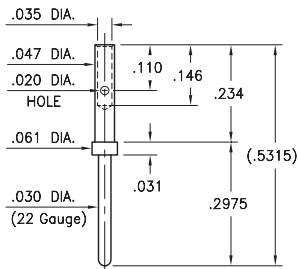

Dimensions per M39029/58-360

3920

3920-0-01-XX-00-00-08-0

Wire crimp termination. Accepts wire sizes 20 AWG Max. / 24 AWG Min.

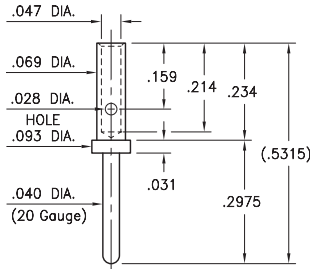

Dimensions per M39029/58-363

3916

3916-0-01-XX-00-00-08-0

Wire crimp termination. Accepts wire sizes 16 AWG Max. / 20 AWG Min.

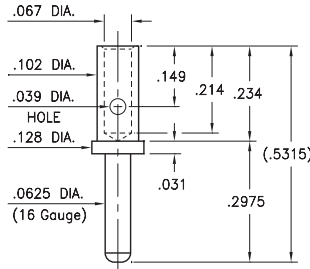

Dimensions per M39029/58-364

3914

3914-0-01-XX-00-00-08-0

Wire crimp termination. Accepts wire sizes 16 AWG Max. / 20 AWG Min.

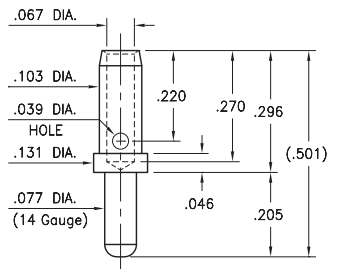

Dimensions per M39029/1-102

3912

3912-0-01-XX-00-00-08-0

Wire crimp termination. Accepts wire sizes 12 AWG Max. / 14 AWG Min.

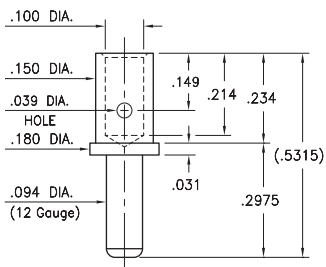

Dimensions per M39029/58-365

SPECIFICATIONS:

Pin Material: Brass Alloy 360, 1/2 Hard (Annealed)

Dimensions: Inches

Tolerances On: Lengths: ±.005
Diameters: ±.002
Angles: ± 2°



ORDER CODE: 39XX - X - 01 - XX - 00 - 00 - 08 - 0

BASIC PART #

SPECIFY PIN FINISH:

- 01 200 μ" TIN/LEAD OVER NICKEL
- ◆ 80 200 μ" TIN OVER NICKEL (RoHS)
- ◆ 15 10 μ" GOLD OVER NICKEL (RoHS)
- ◆ 21 20 μ" GOLD OVER NICKEL (RoHS)
- ◆ 34 50 μ" GOLD OVER NICKEL (RoHS)



MALE PCB PINS

PRINTED CIRCUIT PINS

3975

3975-0-00-XX-00-00-03-0

Solderless press-fit pin for plated through-hole
Recommended drilled hole size: .070 (1,78mm)

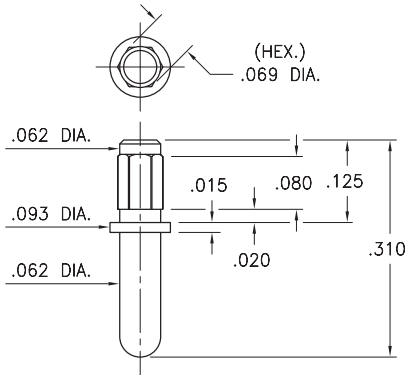

3977

3977-0-00-XX-00-00-03-0

Solderless press-fit pin for plated through-hole
Recommended drilled hole size: .070 (1,78mm)

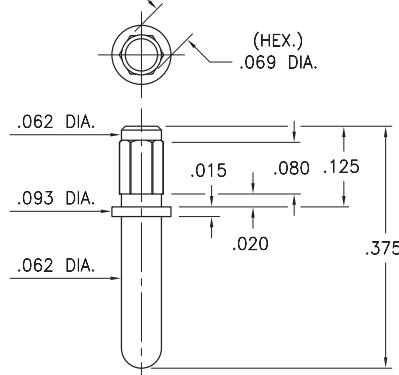

4427

4427-0-00-XX-00-00-03-0

Solderless press-fit pin for plated through-hole
Recommended drilled hole size: .068 (1,73mm)

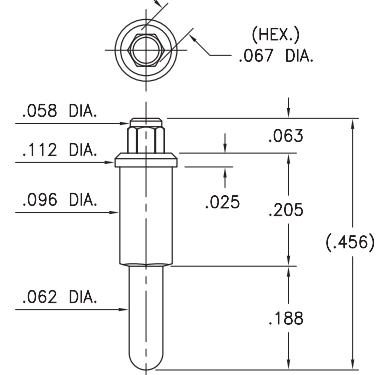

7504

7504-0-00-XX-00-00-03-0

Solderless press-fit pin for plated through-hole
Recommended drilled hole size: .068 (1,73mm)

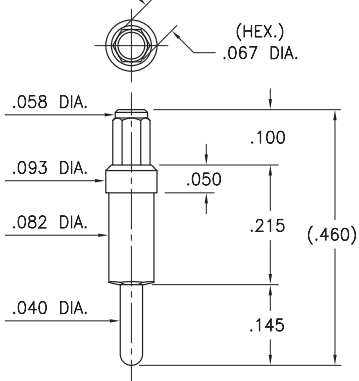

9003

9003-0-00-XX-00-00-03-0

Solderless press-fit pin for plated through-hole
Recommended drilled hole size: .047 (1,19mm)

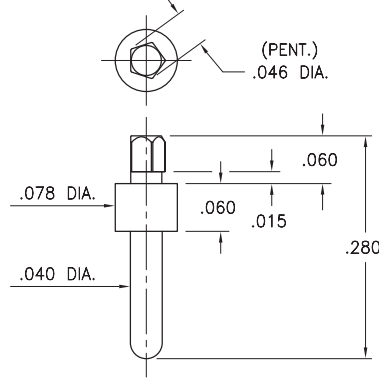

6955

6955-0-05-XX-00-00-03-0

Solderless press-fit pin for plated through-hole
Recommended drilled hole size: .091 (2,31mm)

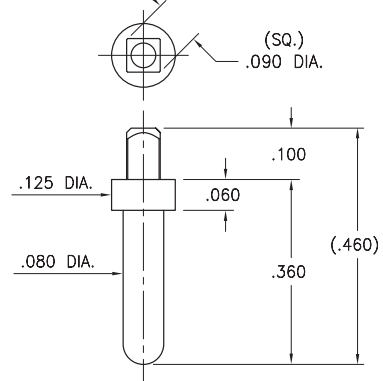

Recommended drilled hole sizes are prior to plating of the PCB and based on typical copper deposition of .5 - 1 oz. This results in a reduction of hole size by approximately .0015" - .003". Depending on surface plating, typical finished hole sizes are .003" - .005" smaller than drilled hole sizes. The finished hole size tolerance for press-fit applications should be specified as +/- .002"

SPECIFICATIONS:

Pin Material: Brass Alloy 360, 1/2 Hard
(Except where noted)

Dimensions: Inches

Tolerances On: Lengths: ±.005
Diameters: ±.002
Angles: ±2°



ORDER CODE: XXXX - 0 - 0X - XX - 00 - 00 - XX - 0

BASIC PART #

SPECIFY PIN FINISH:

- 01 200 μ" TIN/LEAD OVER NICKEL
- ◆ 80 200 μ" TIN OVER NICKEL (RoHS)
- ◆ 15 10 μ" GOLD OVER NICKEL (RoHS)
- ◆ 21 20 μ" GOLD OVER NICKEL (RoHS)
- ◆ 34 50 μ" GOLD OVER NICKEL (RoHS)



MALE PCB PINS

PRINTED CIRCUIT PINS

1655

1655-0-00-XX-00-00-03-0

Solderless press-fit pin for plated through-hole
Recommended drilled hole size: .0505 (1,28mm)

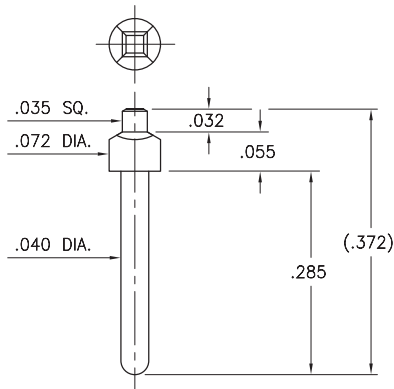

4219

4219-0-05-XX-00-00-03-0

Solderless press-fit pin for plated through-hole
Recommended drilled hole size: .0505 (1,28mm)

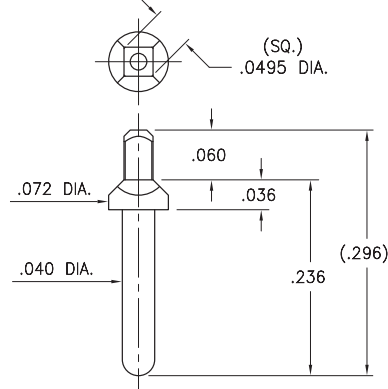

5459

5459-0-00-XX-00-00-03-0

Solderless press-fit pin for plated through-hole
Recommended drilled hole size: .051 (1,3mm)

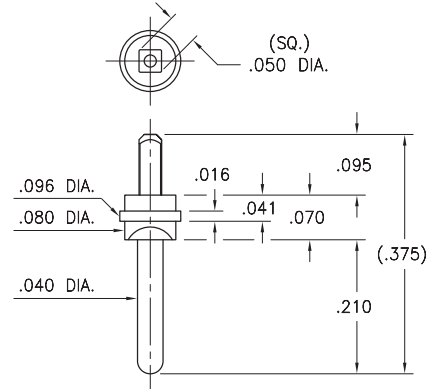

9061

9061-0-00-XX-00-00-03-0

Solderless press-fit pin for plated through-hole
Recommended drilled hole size: .0505 (1,28mm)

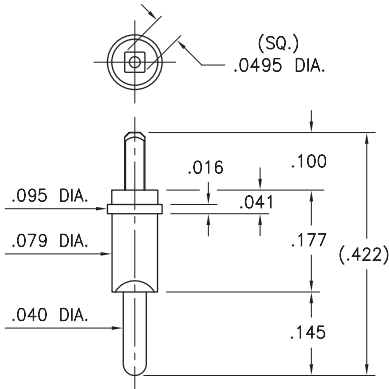

5316

5316-0-00-XX-00-00-03-0

Solderless press-fit pin for plated through-hole
Recommended drilled hole size: .040 (1,02mm)

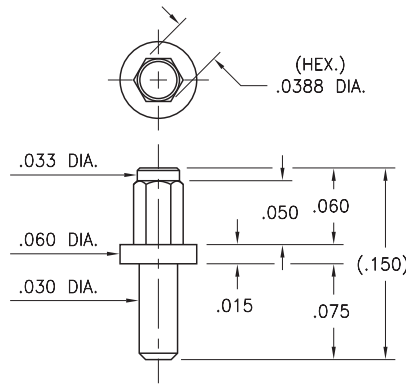

Recommended drilled hole sizes are prior to plating of the PCB and based on typical copper deposition of .5 - 1 oz. This results in a reduction of hole size by approximately .0015" - .003". Depending on surface plating, typical finished hole sizes are .003" - .005" smaller than drilled hole sizes. The finished hole size tolerance for press-fit applications should be specified as +/- .002"

SPECIFICATIONS:

Pin Material: Brass Alloy 360, 1/2 Hard
(Except where noted) *

Dimensions: Inches

Tolerances On: Lengths: ±.005
Diameters: ±.002
Angles: ±2°



ORDER CODE: XXXX - 0 - 0X - XX - 00 - 00 - 03 - 0

BASIC PART # →

SPECIFY PIN FINISH:

- 01 200 μ" TIN/LEAD OVER NICKEL
- ◆ 80 200 μ" TIN OVER NICKEL (RoHS)
- ◆ 15 10 μ" GOLD OVER NICKEL (RoHS)
- ◆ 21 20 μ" GOLD OVER NICKEL (RoHS)
- ◆ 34 50 μ" GOLD OVER NICKEL (RoHS)

MALE PCB PINS

PRINTED CIRCUIT PINS

4118

4118-0-00-XX-00-00-03-0

Solderless press-fit pin for plated through-hole
Recommended drilled hole size: .0295 (0,75mm)

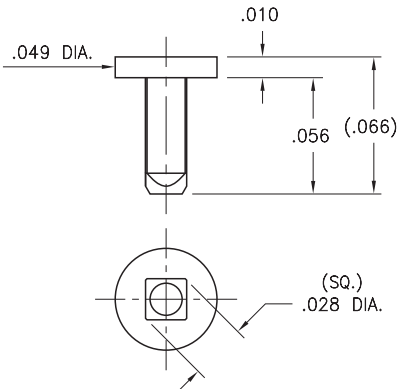

5317

5317-0-00-XX-00-00-03-0

Solderless press-fit pin for plated through-hole
Recommended drilled hole size: .040 (1,02mm)

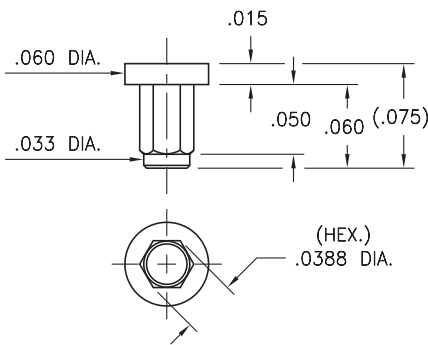

Recommended drilled hole sizes are prior to plating of the PCB and based on typical copper deposition of .5 - 1 oz. This results in a reduction of hole size by approximately .0015" - .003". Depending on surface plating, typical finished hole sizes are .003" - .005" smaller than drilled hole sizes. The finished hole size tolerance for press-fit applications should be specified as +/- .002"

SPECIFICATIONS:

Pin Material: Brass Alloy 360, 1/2 Hard
(Except where noted) *

Dimensions: Inches

Tolerances On: Lengths: ±.005
Diameters: ±.002
Angles: ±2°



ORDER CODE: XXXX - 0 - 0X - XX - 00 - 00 - XX - 0

BASIC PART #

SPECIFY PIN FINISH:

- 01 200 μ" TIN/LEAD OVER NICKEL
- ◆ 80 200 μ" TIN OVER NICKEL (RoHS)
- ◆ 15 10 μ" GOLD OVER NICKEL (RoHS)
- ◆ 21 20 μ" GOLD OVER NICKEL (RoHS)
- ◆ 34 50 μ" GOLD OVER NICKEL (RoHS)

MALE PCB PINS

PRINTED CIRCUIT PINS

5231

5231-0-00-XX-00-00-38-0

Swage mount in .094 hole
For a .125 thick board

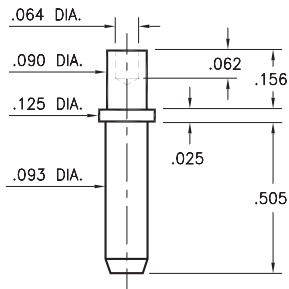

9092

9092-0-00-XX-00-00-38-0

Wire crimp termination up to 14 AWG

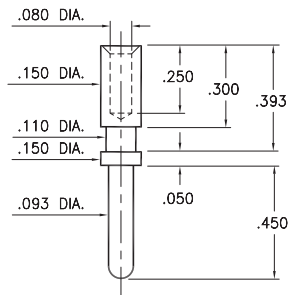

7310

7310-0-01-XX-00-00-08-0

Board edge press-fit

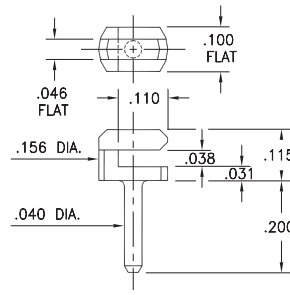

5066

5066-0-00-26-00-00-03-0

Press-fit in .043 mounting hole

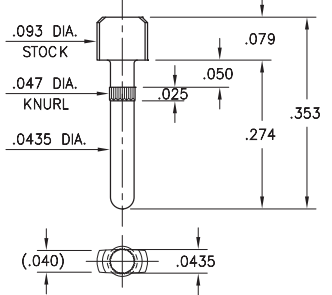

7937

7937-0-00-15-00-00-03-0

Target contact, horizontal surface mount
Also available on 16mm wide carrier tape:
2,400 parts per 13" reel.
See page 224.4 for Tape & Reel details

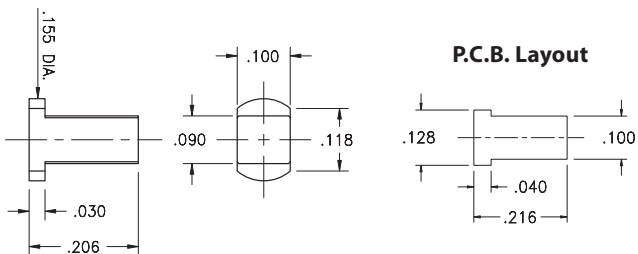

1502

1502-0-00-XX-00-00-03-0

Press-fit in .057 mounting hole

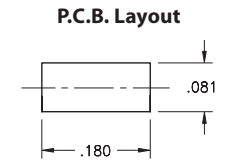
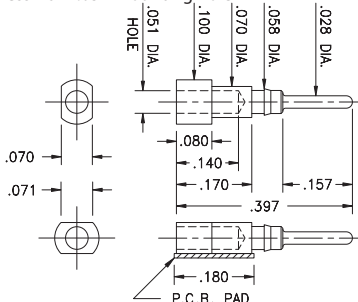

5102

5102-0-00-XX-00-00-33-0

Press-fit in .057 mounting hole

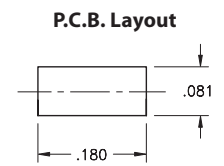
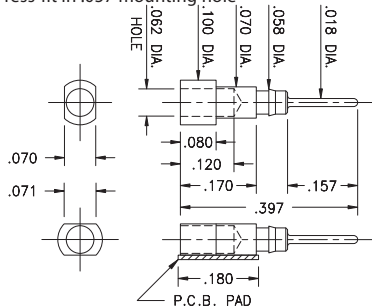

1508

1508-0-00-15-00-00-03-0

Test point, surface mount
Also available on 16mm wide carrier tape:
1,600 parts per 13" reel.
See page 224.4 for Tape & Reel details

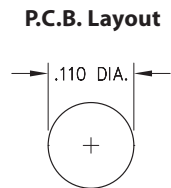
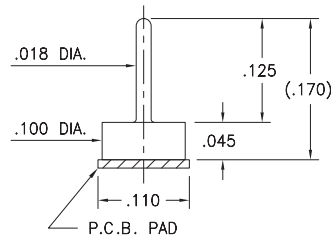

SPECIFICATIONS:

Pin Material: Brass Alloy 360, 1/2 Hard
(Except swage pins which are annealed)

Dimensions: Inches

Tolerances On: Lengths: ±.005
Diameters: ±.002
Angles: ± 2°



ORDER CODE: XXXX - X - 0X - XX - 00 - 00 - XX - 0

BASIC PART #

SPECIFY PIN FINISH:

- 01 200 μ" TIN/LEAD OVER NICKEL
- ◆ 80 200 μ" TIN OVER NICKEL (RoHS)
- ◆ 15 10 μ" GOLD OVER NICKEL (RoHS)
- ◆ 21 20 μ" GOLD OVER NICKEL (RoHS)
- ◆ 34 50 μ" GOLD OVER NICKEL (RoHS)



MALE PCB PINS

PINS ON TAPE & REEL PACKAGING

4825

4825-0-57-XX-00-00-33-0

Solder mount in .019 mounting hole
16mm wide X 8mm pitch carrier tape:
3,250 parts per 13" reel.

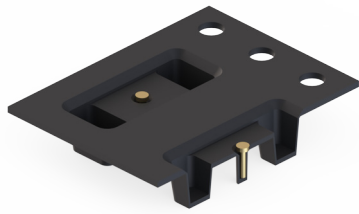
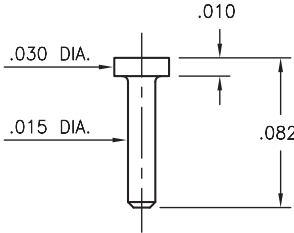

4288

4288-0-57-XX-00-00-33-0

Solder mount in .022 mounting hole
16mm wide X 8mm pitch carrier tape:
3,250 parts per 13" reel.

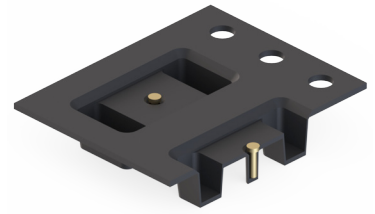
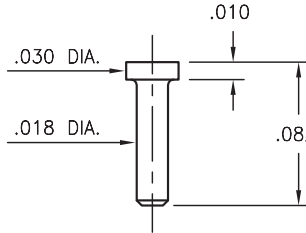

4353

4353-0-57-XX-00-00-33-0

Solder mount in .016 mounting hole
16mm wide X 8mm pitch carrier tape:
3,040 parts per 13" reel.

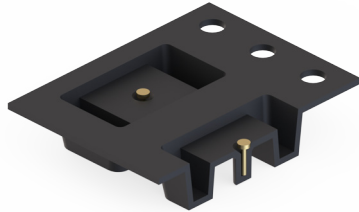
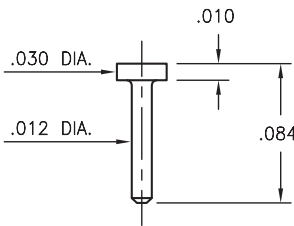

4068

4068-0-57-XX-00-00-33-0

Solder mount in .022 mounting hole
16mm wide X 8mm pitch carrier tape:
2,000 parts per 13" reel.

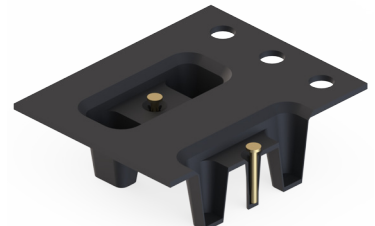
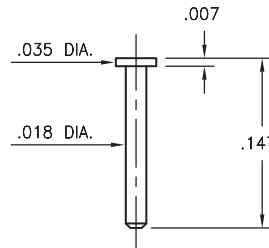

6547

6547-0-57-XX-00-00-33-0

Solder mount in .024 mounting hole
24mm wide X 8mm pitch carrier tape:
1,080 parts per 13" reel.

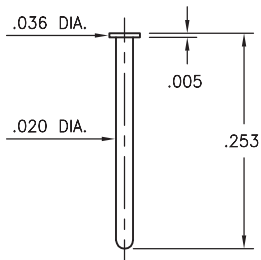

9083

9083-0-57-XX-00-00-38-0

Solder mount in .016 mounting hole
16mm wide X 8mm pitch carrier tape:
1,950 parts per 13" reel.

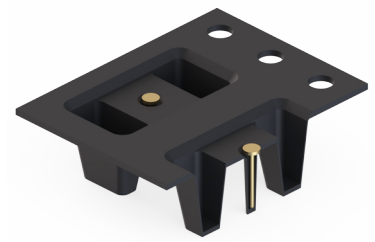
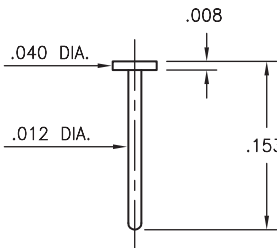

SPECIFICATIONS:

Pin Material: Brass Alloy 360, 1/2 Hard
(Except where noted)

Dimensions: Inches

Tolerances On: Lengths: $\pm .005$
Diameters: $\pm .002$
Angles: $\pm 2^\circ$



ORDER CODE: XXXX - X - 00 - XX - 00 - 00 - XX - 0

BASIC PART # →

→ **SPECIFY PIN FINISH:**

- 01 200 μ " TIN/LEAD OVER NICKEL
- ◆ 80 200 μ " TIN OVER NICKEL (RoHS)
- ◆ 15 10 μ " GOLD OVER NICKEL (RoHS)
- ◆ 21 20 μ " GOLD OVER NICKEL (RoHS)
- ◆ 34 50 μ " GOLD OVER NICKEL (RoHS)



MALE PCB PINS

PINS ON TAPE & REEL PACKAGING

5058

5058-0-57-XX-00-00-03-0

Solder mount in .024 mounting hole
16mm wide X 8mm pitch carrier tape:
2,000 parts per 13" reel.

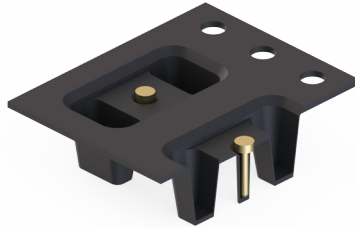
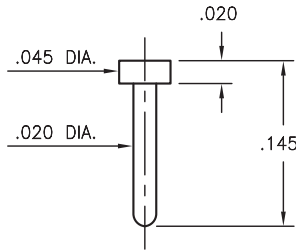

9113

9113-0-57-XX-00-00-38-0

Solder mount in .022 mounting hole
16mm wide X 8mm pitch carrier tape:
1,800 parts per 13" reel.

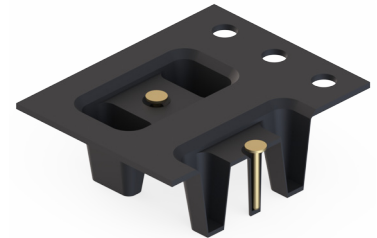
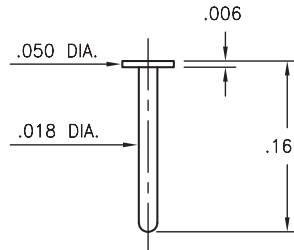

4965

4965-0-57-XX-00-00-33-0

Solder mount in .024 mounting hole
24mm wide X 8mm pitch carrier tape:
1,300 parts per 13" reel.

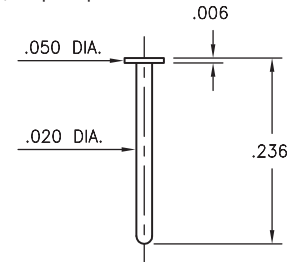

4361

4361-0-57-XX-00-00-33-0

Solder mount in .022 mounting hole
16mm wide X 8mm pitch carrier tape:
3,600 parts per 13" reel.

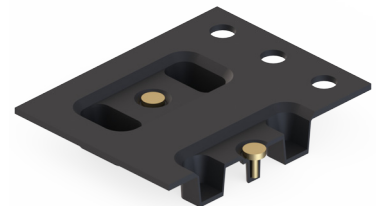
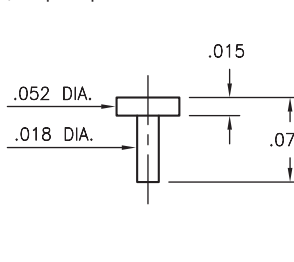

4477

4477-0-57-XX-00-00-33-0

Solder mount in .034 mounting hole
24mm wide X 8mm pitch carrier tape:
1,300 parts per 13" reel.

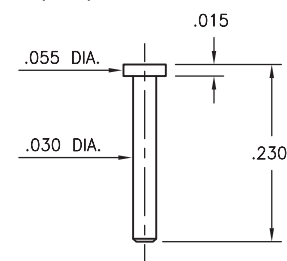

3137

3137-1-57-XX-00-00-08-0

Solder mount in .043 mounting hole
16mm wide X 12mm pitch carrier tape:
580 parts per 13" reel.

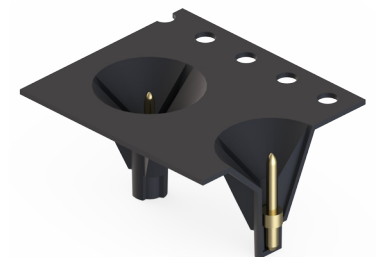
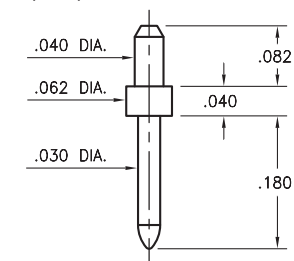

SPECIFICATIONS:

Pin Material: Brass Alloy 360, 1/2 Hard
(Except where noted)

Dimensions: Inches

Tolerances On: Lengths: $\pm .005$
Diameters: $\pm .002$
Angles: $\pm 2^\circ$



ORDER CODE: XXXX - X - 00 - XX - 00 - 00 - XX - 0

BASIC PART #

SPECIFY PIN FINISH:

- 01 200 μ " TIN/LEAD OVER NICKEL
- ◆ 80 200 μ " TIN OVER NICKEL (RoHS)
- ◆ 15 10 μ " GOLD OVER NICKEL (RoHS)
- ◆ 21 20 μ " GOLD OVER NICKEL (RoHS)
- ◆ 34 50 μ " GOLD OVER NICKEL (RoHS)



MALE PCB PINS

PINS ON TAPE & REEL PACKAGING

8330

8330-0-57-XX-00-00-03-0

Solder mount in .044 mounting hole
24mm wide X 12mm pitch carrier tape:
610 parts per 13" reel.

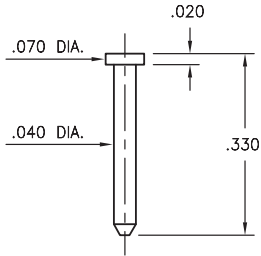

0286

0286-0-57-XX-00-00-03-0

Press-fit in .057 mounting hole
16mm wide X 8mm pitch carrier tape:
2,500 parts per 13" reel.

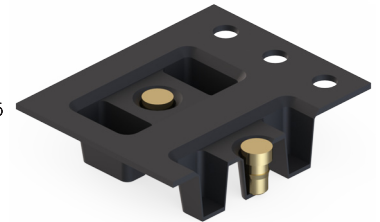
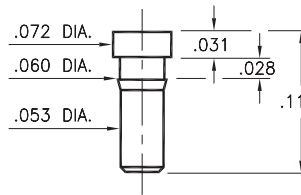

9265

9265-0-57-XX-00-00-38-0

Solder mount in .063 mounting hole
16mm wide X 8mm pitch carrier tape:
1,170 parts per 13" reel.

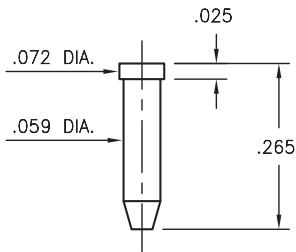

2381

2381-0-57-XX-00-00-33-0

Solder mount in .054 mounting hole
16mm wide X 8mm pitch carrier tape:
1,800 parts per 13" reel.

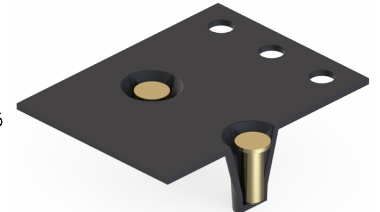
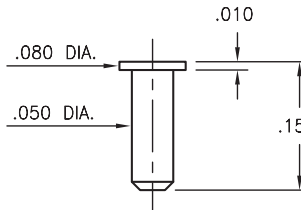

1944

1944-0-57-15-00-00-03-0

Flat face Target contact, surface mount
16mm wide X 8mm pitch carrier tape:
2,200 parts per 13" reel.

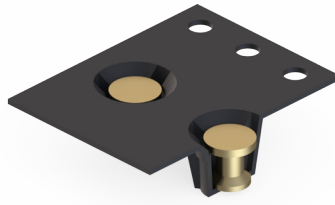
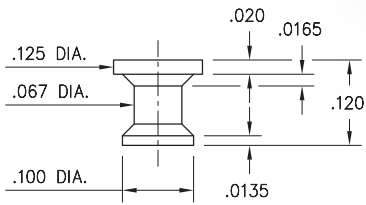

P.C.B. Layout

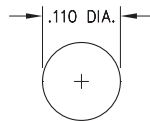

1943

1943-0-57-15-00-00-03-0

Concave face Target contact, surface mount
16mm wide X 8mm pitch carrier tape:
2,200 parts per 13" reel.

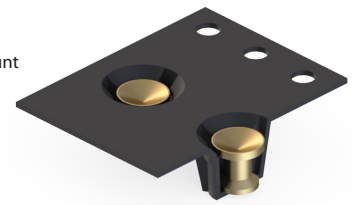
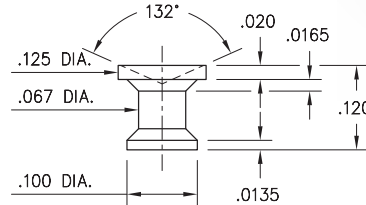

P.C.B. Layout

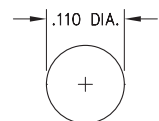

SPECIFICATIONS:

Pin Material: Brass Alloy 360, 1/2 Hard
(Except where noted)

Dimensions: Inches

Tolerances On: Lengths: $\pm .005$
Diameters: $\pm .002$
Angles: $\pm 2^\circ$



ORDER CODE: XXXX - X - 00 - XX - 00 - 00 - XX - 0

BASIC PART #

SPECIFY PIN FINISH:

- 01 200 μ " TIN/LEAD OVER NICKEL
- ◆ 80 200 μ " TIN OVER NICKEL (RoHS)
- ◆ 15 10 μ " GOLD OVER NICKEL (RoHS)
- ◆ 21 20 μ " GOLD OVER NICKEL (RoHS)
- ◆ 34 50 μ " GOLD OVER NICKEL (RoHS)



MALE PCB PINS

PINS ON TAPE & REEL PACKAGING

9022

9022-0-57-XX-00-00-33-0

Solder mount in .066 mounting hole
24mm wide X 8mm pitch carrier tape:
1,500 parts per 13" reel.

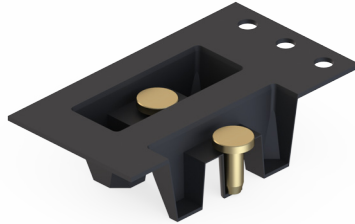
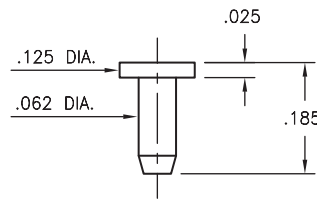

7937

7937-0-58-15-00-00-03-0

Target contact, horizontal surface mount
16mm wide X 8mm pitch carrier tape:
2,400 parts per 13" reel.

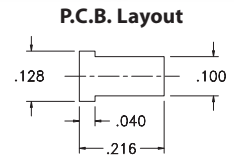
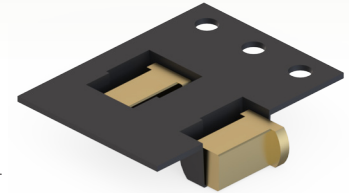
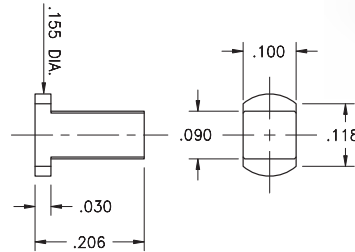

8086

8086-0-57-XX-00-00-33-0

Solder mount in .079 mounting hole
12mm wide X 8mm pitch carrier tape:
550 parts per 13" reel.

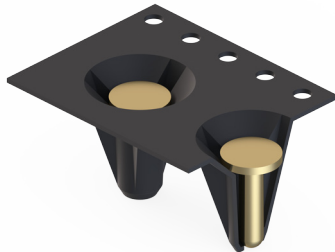
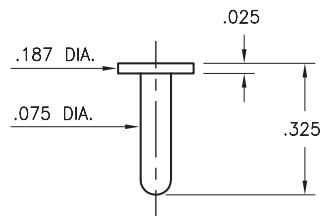

8086

8086-0-59-XX-00-00-33-0

Surface mount
24mm wide X 16mm pitch carrier tape:
450 parts per 13" reel.

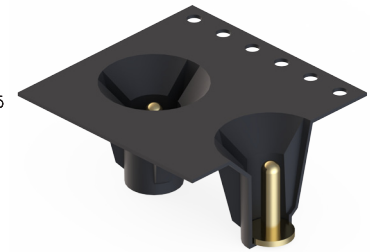
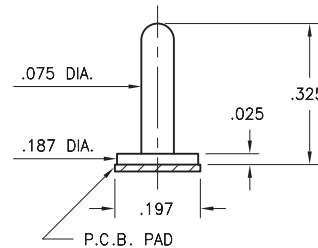

1508

1508-0-57-15-00-00-03-0

Test point, surface mount
16mm wide X 8mm pitch carrier tape:
1,600 parts per 13" reel.

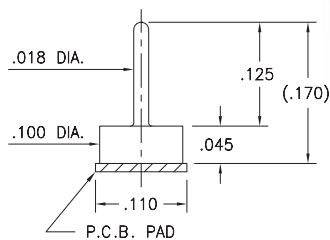

P.C.B. Layout

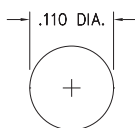

SPECIFICATIONS:

Pin Material: Brass Alloy 360, 1/2 Hard
(Except where noted)

Dimensions: Inches

Tolerances On: Lengths: $\pm .005$
Diameters: $\pm .002$
Angles: $\pm 2^\circ$



ORDER CODE: XXXX - X - 00 - XX - 00 - 00 - XX - 0

BASIC PART #

SPECIFY PIN FINISH:

- 01 200 μ " TIN/LEAD OVER NICKEL
- ◆ 80 200 μ " TIN OVER NICKEL (RoHS)
- ◆ 15 10 μ " GOLD OVER NICKEL (RoHS)
- ◆ 21 20 μ " GOLD OVER NICKEL (RoHS)
- ◆ 34 50 μ " GOLD OVER NICKEL (RoHS)



MALE PCB PINS

WRAPOST TERMINALS

5275

5275-X-05-XX-00-00-01-0

Square press-fit in .035 plated through-hole

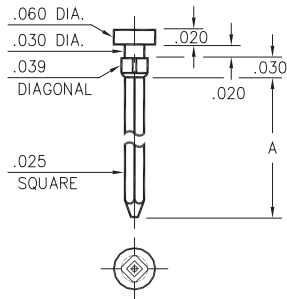

Basic Part Number	# of Wraps	Length A
5275-1	1	.370
5275-2	2	.470
5275-3	3	.610

1010 ⇔ 1012/1020 ⇔ 1022

10XX-X-05-XX-00-00-01-0

Press-fit in .057 mounting hole

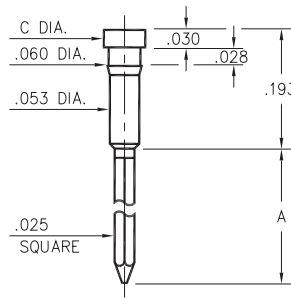

Basic Part Number	# of Wraps	Wrappost Length A	Head Dia. C
1012-1	1	.260	.072
1011-2	2	.360	
1010-3	3	.500	
1022-1	1	.260	.062
1021-2	2	.360	
1020-3	3	.500	

1215

1215-3-05-XX-00-00-01-0

Press-fit in .043 mounting hole

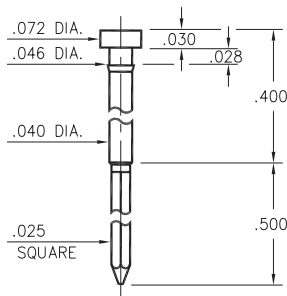

1124

1124-0-05-XX-00-00-01-0

Press-fit in .043 mounting hole

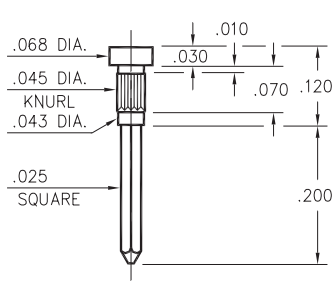

1210

1210-0-05-XX-00-00-01-0

Press-fit in .053 mounting hole

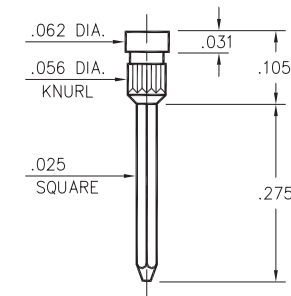

1222

1222-0-05-XX-00-00-01-0

Press-fit in .055 mounting hole

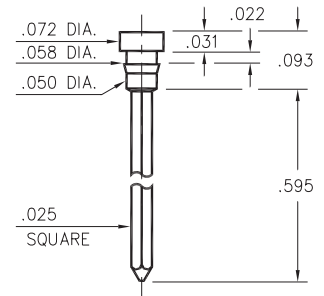

1221

1221-0-05-XX-00-00-01-0

Press-fit in .056 mounting hole

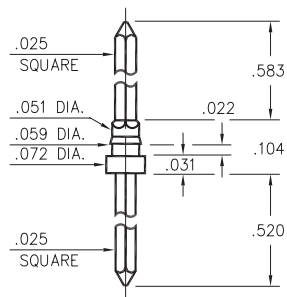

1110

1110-3-05-XX-00-00-01-0

Press-fit in .057 mounting hole

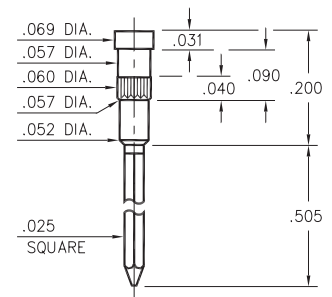

1094

1094-0-05-XX-00-00-01-0

Press-fit in .056 mounting hole

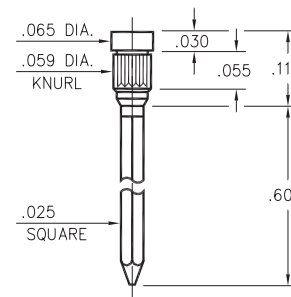

SPECIFICATIONS:

Pin Material: Brass Alloy 360, 1/2 Hard
(Except where noted)

Dimensions: Inches

Tolerances On: Lengths: ±.005
Diameters: ±.002
Angles: ± 2°



ORDER CODE: **XXXX - X - 05 - XX - 00 - 00 - 01 - 0**

BASIC PART #

SPECIFY PIN FINISH:

- 01 200 μ" TIN/LEAD OVER NICKEL
- ◆ 80 200 μ" TIN OVER NICKEL (RoHS)
- ◆ 15 10 μ" GOLD OVER NICKEL (RoHS)
- ◆ 21 20 μ" GOLD OVER NICKEL (RoHS)



MALE PCB PINS

WRAPOST TERMINALS

1030 → 1032

103X-X-05-XX-00-00-01-0

Press-fit in .057 mounting hole

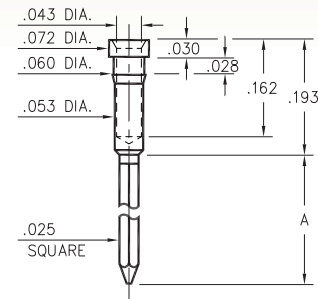

Basic Part Number	# of Wraps	Length A
1032-1	1	.260
1031-2	2	.360
1030-3	3	.500

1216

1216-0-05-XX-00-00-01-0

Press-fit in .056 mounting hole

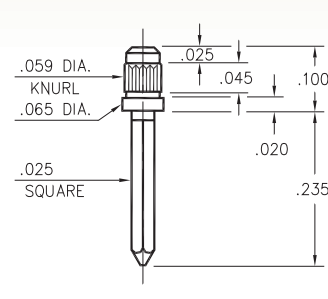

1095

1095-0-05-XX-00-00-01-0

Swage mount in .094 hole

For a .062 thick board

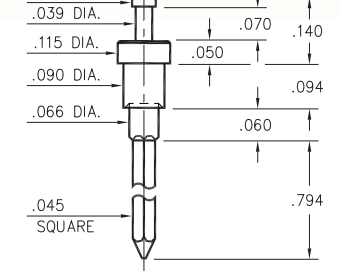

1214

1214-0-05-XX-00-00-01-0

Press-fit in .059 mounting hole

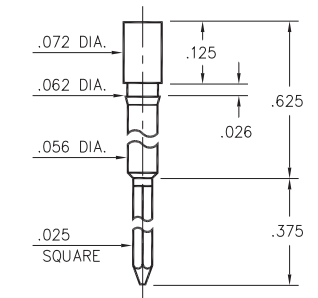

1212

1212-0-05-XX-00-00-01-0

Press-fit in .061 mounting hole

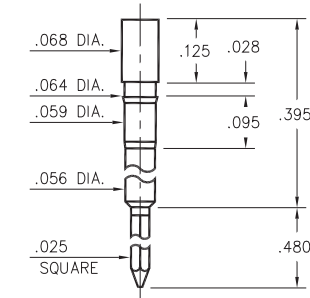

1213

1213-0-05-XX-00-00-01-0

Press-fit in .061 mounting hole

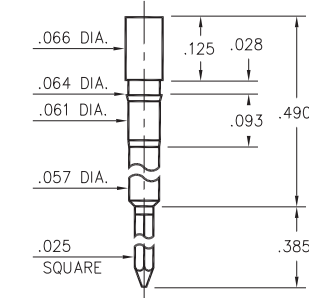

0318

0318-3-05-XX-00-00-01-0

Press-fit in .057 mounting hole

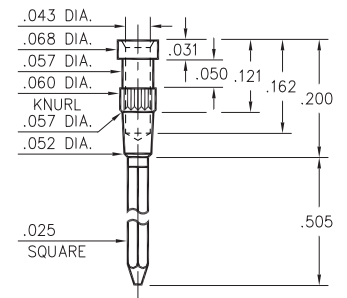

1302

1302-0-05-XX-00-00-01-0

Press-fit in .057 mounting hole

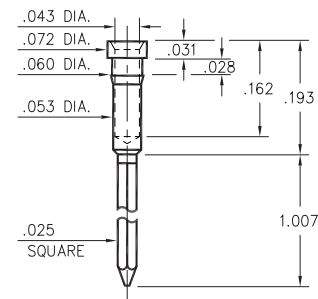

1097

1097-0-05-XX-00-00-01-0

Swage mount in .094 hole

For a .062 thick board

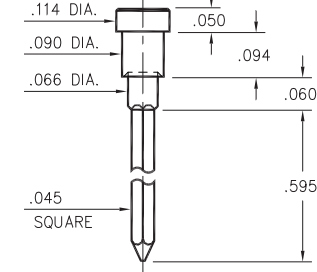

SPECIFICATIONS:

Pin Material: Brass Alloy 360, 1/2 Hard
(Except swage pins which are annealed)

Dimensions: Inches

Tolerances On: Lengths: ± .005
Diameters: ± .002
Angles: ± 2°



ORDER CODE: XXXX - X - 05 - XX - 00 - 00 - 01 - 0

BASIC PART #

SPECIFY PIN FINISH:

- 01 200 μ" TIN/LEAD OVER NICKEL
- ◆ 80 200 μ" TIN OVER NICKEL (RoHS)
- ◆ 15 10 μ" GOLD OVER NICKEL (RoHS)
- ◆ 21 20 μ" GOLD OVER NICKEL (RoHS)



MALE PCB PINS

WRAPOST TERMINALS

8301

8301-X-24-XX-00-00-01-0

Press-fit in .057 mounting hole

For wire sizes up to 22 AWG

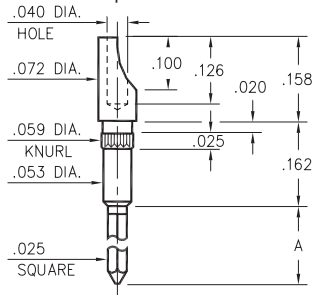

Basic Part Number	# of Wraps	Length A
8301-2	2	.370
8301-3	3	.510

1083

1083-0-05-XX-00-00-01-0

Press-fit in .059 mounting hole

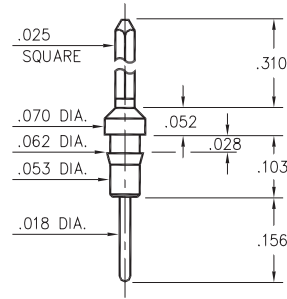

5301

5301-0-05-XX-00-00-01-0

Press-fit in .057 mounting hole

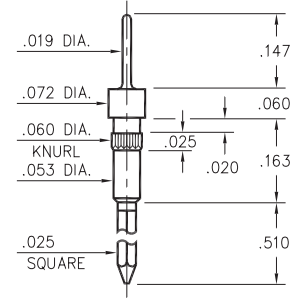

1090

1090-0-05-XX-00-00-01-0

Press-fit in .059 mounting hole

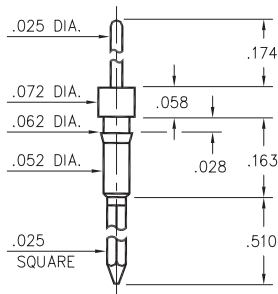

8608

8608-0-05-XX-00-00-01-0

Press-fit in .056 mounting hole

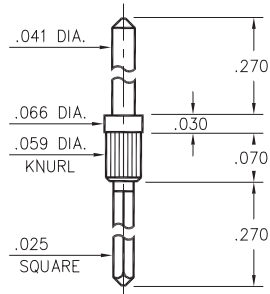

SPECIFICATIONS:

Pin Material: Brass Alloy 360, 1/2 Hard
(Except where noted)

Dimensions: Inches

Tolerances On: Lengths: $\pm .005$
Diameters: $\pm .002$
Angles: $\pm 2^\circ$



ORDER CODE: XXXX - X - XX - XX - 00 - 00 - 01 - 0

BASIC PART #

SPECIFY PIN FINISH:

- 01 200 μ " TIN/LEAD OVER NICKEL
- ◆ 80 200 μ " TIN OVER NICKEL (RoHS)
- ◆ 15 10 μ " GOLD OVER NICKEL (RoHS)
- ◆ 21 20 μ " GOLD OVER NICKEL (RoHS)



MALE PCB PINS

WRAPOST TERMINALS

1096

1096-X-05-XX-00-00-01-0

Press-fit in .057 mounting hole

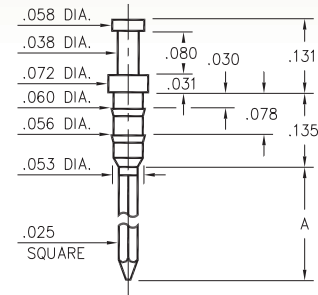

Basic Part Number	# of Wraps	Length A
1096-2	2	.381
1096-3	3	.527

1106

1106-X-23-XX-00-00-01-0

Press-fit in .057 mounting hole

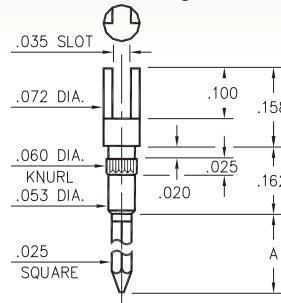

Basic Part Number	# of Wraps	Length A
1106-2	2	.370
1106-3	3	.510

1093

1093-0-05-XX-00-00-01-0

Press-fit in .056 mounting hole

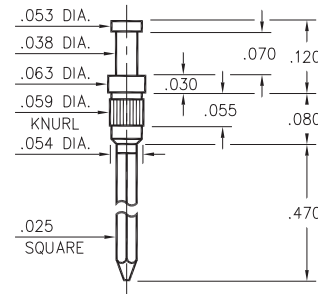

0730

0730-3-05-XX-00-00-01-0

Press-fit in .057 mounting hole

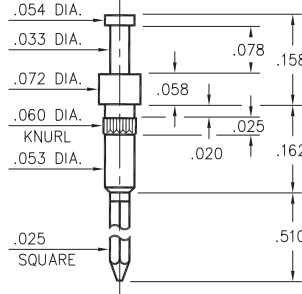

1122

1122-0-22-XX-00-00-01-0

Press-fit in .053 mounting hole

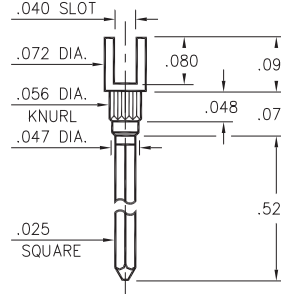

1064

1064-0-23-XX-00-00-01-0

Press-fit in .056 mounting hole

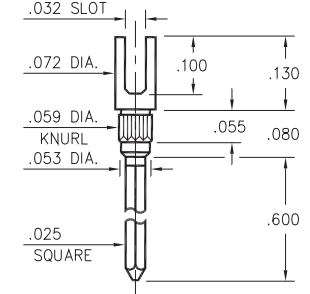

1092

1092-0-05-XX-00-00-01-0

Press-fit in .056 mounting hole

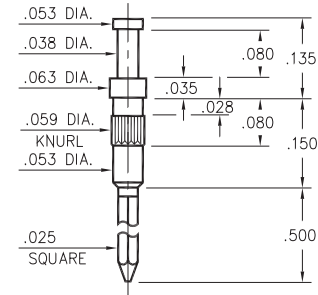

1068

1068-0-23-XX-00-00-01-0

Press-fit in .057 mounting hole

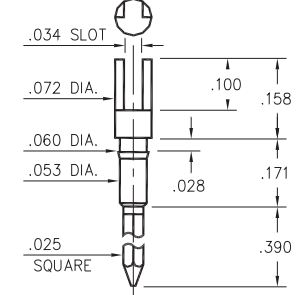

1070 → 1072

107X-X-23-XX-00-00-01-0

Press-fit in .057 mounting hole

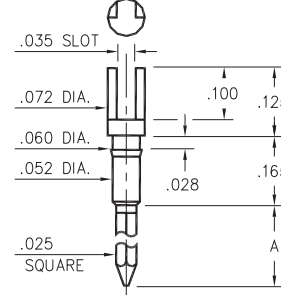

Basic Part Number	# of Wraps	Length A
1072-1	1	.260
1071-2	2	.370
1070-3	3	.510

SPECIFICATIONS:

Pin Material: Brass Alloy 360, 1/2 Hard
(Except where noted)

Dimensions: Inches

Tolerances On: Lengths: ±.005
Diameters: ±.002
Angles: ±2°



ORDER CODE: XXXX - X - XX - XX - 00 - 00 - 01 - 0

BASIC PART #

SPECIFY PIN FINISH:

- 01 200 μ" TIN/LEAD OVER NICKEL
- ◆ 80 200 μ" TIN OVER NICKEL (RoHS)
- ◆ 15 10 μ" GOLD OVER NICKEL (RoHS)
- ◆ 21 20 μ" GOLD OVER NICKEL (RoHS)



MALE PCB PINS

SOLDER TERMINAL TURRETS

2111

2111-X-00-XX-00-00-07-0

Swage mount in .033 hole

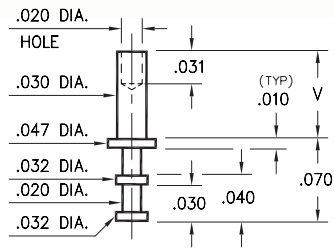

Basic Part Number	Board Thickness	Length V
2111-1	.031	.053
2111-2	.062	.084
2111-3	.094	.115

2113

2113-X-00-XX-00-00-07-0

Swage mount in .043 hole

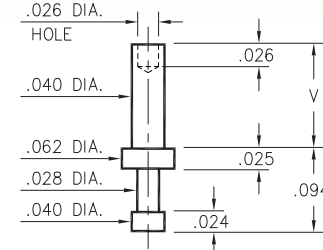

Basic Part Number	Board Thickness	Length V
2113-1	.031	.053
2113-2	.062	.084
2113-3	.094	.115
2113-4	.125	.147

2108

2108-X-00-XX-00-00-07-0

Swage mount in .043 hole

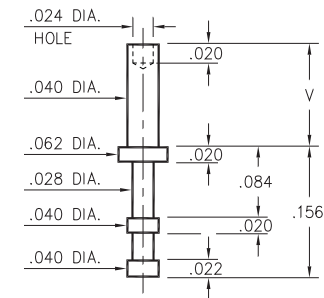

Basic Part Number	Board Thickness	Length V
2108-1	.031	.053
2108-2	.062	.084
2108-3	.094	.115
2108-4	.125	.147

2102

2102-X-00-XX-00-00-07-0

Swage mount in .052 hole

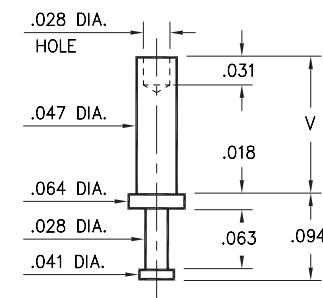

Basic Part Number	Board Thickness	Length V
2102-5	.016	.035
2102-1	.031	.054
2102-2	.062	.084
2102-3	.094	.115
2102-4	.125	.147

2109

2109-X-00-XX-00-00-07-0

Swage mount in .052 hole

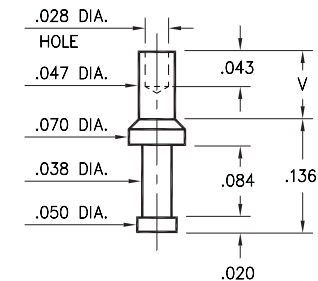

Basic Part Number	Board Thickness	Length V
2109-1	.031	.052
2109-2	.062	.085

2324

2324-2-00-XX-00-00-07-0

Swage mount in .052 hole
For a .062 thick board

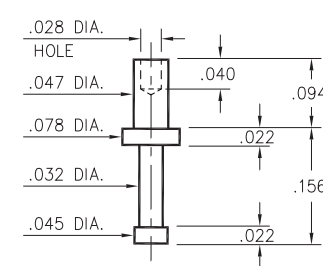

SPECIFICATIONS:

Pin Material: Brass Alloy 360, 1/2 Hard
(Swage pins are annealed)

Dimensions: Inches

Tolerances On: Lengths: ±.005
Diameters: ±.002
Angles: ± 2°



ORDER CODE: XXXX - X - 00 - XX - 00 - 00 - 07 - 0

BASIC PART #

SPECIFY PIN FINISH:

- 01 200 μ" TIN/LEAD OVER NICKEL
- ◆ 80 200 μ" TIN OVER NICKEL (RoHS)
- ◆ 44 300 μ" SILVER OVER COPPER (RoHS)
- 50 300 μ" ELECTRO-SOLDER
(60/40 SnPb)



MALE PCB PINS

SOLDER TERMINAL TURRETS

2312

2312-X-00-XX-00-00-07-0

Swage mount in .064 hole

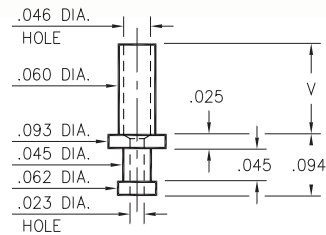

Basic Part Number	Board Thickness	Length V
2312-1	.031	.053
2312-2	.062	.094
2312-3	.094	.115
2312-4	.125	.147

2308

2308-X-00-XX-00-00-07-0

Swage mount in .064 hole

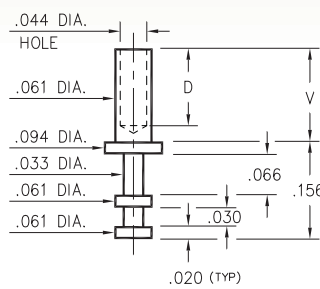

Basic Part Number	Board Thickness	Length V	Depth D
2308-1	.031	.054	.036
2308-2	.062	.084	.066
2308-3	.094	.115	.096
2308-4	.125	.147	.126

2707

2707-X-00-XX-00-00-07-0

Swage mount in .120 hole

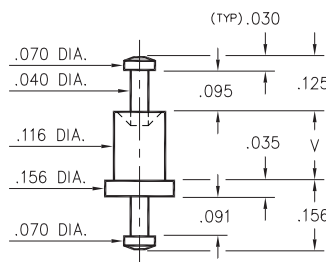

Basic Part Number	Board Thickness	Length V
2707-1	.031	.062
2707-2	.062	.094
2707-3	.094	.125
2707-4	.125	.156

2329

2329-X-00-XX-00-00-07-0

Swage mount in .067 hole

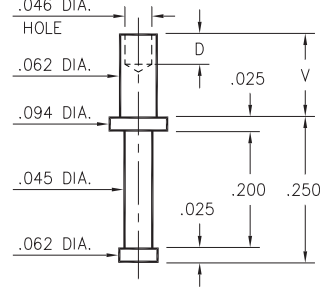

Basic Part Number	Board Thickness	Length V	Depth D
2329-1	.031	.045	.045
2329-2	.062	.094	.062
2329-3	.094	.125	.062
2329-4	.125	.156	.062

2510

2510-X-00-XX-00-00-07-0

Swage mount in .064 hole

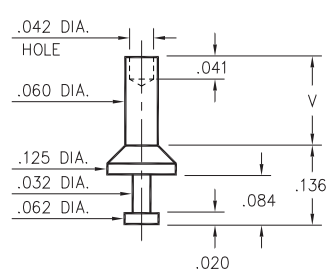

2513

2513-X-00-XX-00-00-07-0

Swage mount in .064 hole

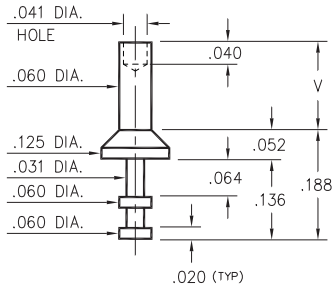

Basic Part Number	Board Thickness	Length V
251X-1	.031	.062
251X-2	.062	.094
251X-3	.094	.125
251X-4	.125	.156

SPECIFICATIONS:

Pin Material: Brass Alloy 360, 1/2 Hard
(Swage pins are annealed)

Dimensions: Inches

Tolerances On: Lengths: ±.005
Diameters: ±.002
Angles: ±2°



ORDER CODE: XXXX - X - 00 - XX - 00 - 00 - 07 - 0

BASIC PART #

SPECIFY PIN FINISH:

- 01 200 μ" TIN/LEAD OVER NICKEL
- ◆ 80 200 μ" TIN OVER NICKEL (RoHS)
- ◆ 44 300 μ" SILVER OVER COPPER (RoHS)
- 50 300 μ" ELECTRO-SOLDER (60/40 SnPb)



MALE PCB PINS

SOLDER TERMINAL TURRETS

2110

2110-X-00-XX-00-00-07-0

Swage mount in .052 hole

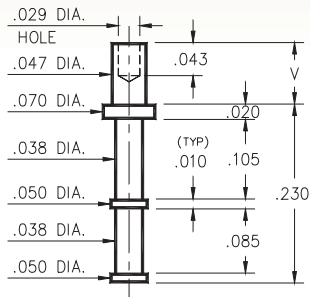

Basic Part Number	Board Thickness	Length V
2110-1	.031	.049
2110-2	.062	.082

2333

2333-X-00-XX-00-00-07-0

Press-fit & swage in .052 mounting hole

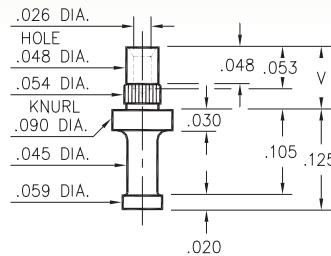

Basic Part Number	Board Thickness	Length V
2333-1	.078	.103
2333-2	.062	.087
2333-3	.047	.072

2821

2821-X-00-XX-00-00-07-0

Swage mount in .125 hole

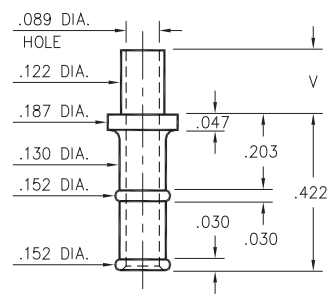

Basic Part Number	Board Thickness	Length V
2821-2	.062	.109
2821-3	.094	.141
2821-4	.125	.172

2533

2533-0-00-XX-00-00-07-0

Press-fit & swage in .052 mounting hole
For a .062 thick board

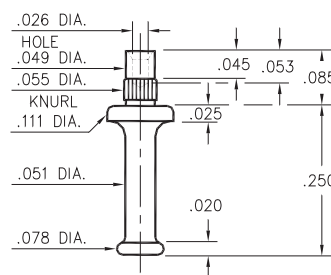

2101

2101-3-00-XX-00-00-07-0

Press-fit in .053 mounting hole
For a .062 to .094 thick board

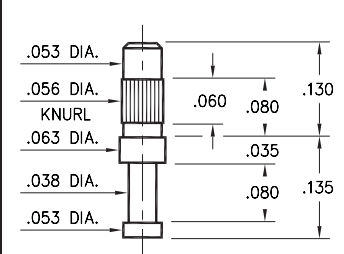

2316

2316-X-00-XX-00-00-07-0

Swage mount in .064 hole

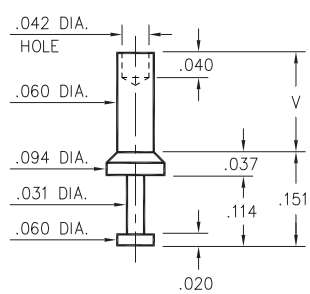

2317

2317-X-00-XX-00-00-07-0

Swage mount in .064 hole

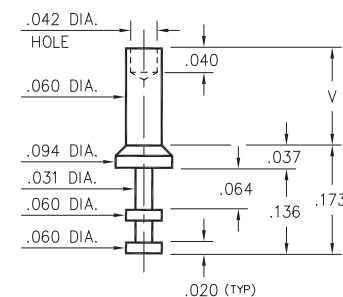

2708

2708-X-00-XX-00-00-07-0

Swage mount in .120 hole

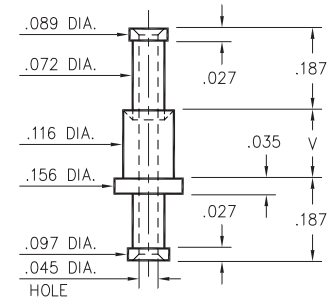

Basic Part Number	Board Thickness	Length V
2XXX-1	.031	.062
2XXX-2	.062	.094
2XXX-3	.094	.125
2XXX-4	.125	.156

SPECIFICATIONS:

Pin Material: Brass Alloy 360, 1/2 Hard
(Swage pins are annealed)

Dimensions: Inches

Tolerances On: Lengths: ±.005
Diameters: ±.002
Angles: ±2°



ORDER CODE: **XXXX - X - 00 - XX - 00 - 00 - 07 - 0**

BASIC PART #

SPECIFY PIN FINISH:

- 01 200 μ" TIN/LEAD OVER NICKEL
- ◆ 80 200 μ" TIN OVER NICKEL (RoHS)
- ◆ 44 300 μ" SILVER OVER COPPER (RoHS)
- 50 300 μ" ELECTRO-SOLDER
(60/40 SnPb)



MALE PCB PINS

SOLDER TERMINAL TURRETS

2348

2348-X-00-XX-00-00-07-0

Swage mount in .064 hole

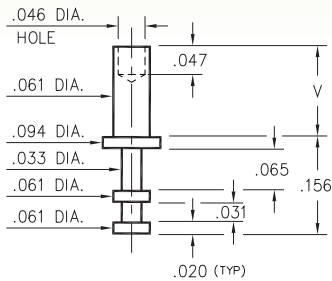

2301

2301-X-00-XX-00-00-07-0

Swage mount in .067 hole

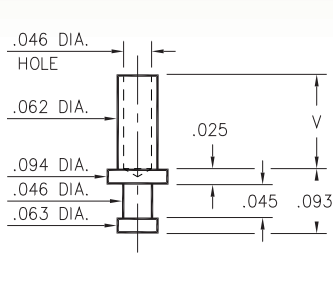

2506

2506-X-00-XX-00-00-07-0

Swage mount in .067 hole

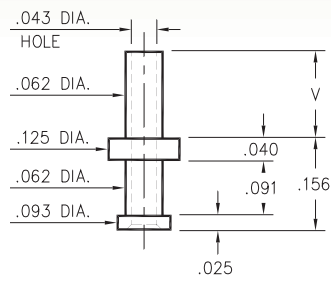

Basic Part Number	Board Thickness	Length V
2XXX-1	.031	.053
2XXX-2	.062	.084
2XXX-3	.094	.115
2XXX-4	.125	.147

2310

2310-X-00-XX-00-00-07-0

Swage mount in .067 hole

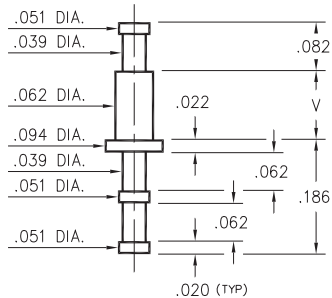

Basic Part Number	Board Thickness	Length V
2310-1	.031	.053
2310-2	.062	.082
2310-3	.094	.113
2310-4	.125	.145

2505

2505-X-00-XX-00-00-07-0

Swage mount in .076 hole

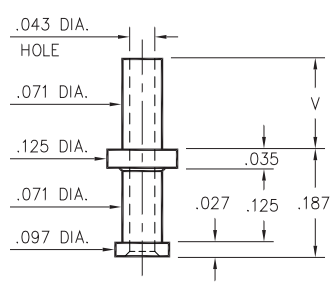

Basic Part Number	Board Thickness	Length V
2505-1	.031	.062
2505-2	.062	.093
2505-3	.094	.125
2505-4	.125	.156

2325

2325-X-00-XX-00-00-07-0

Swage mount in .073 hole

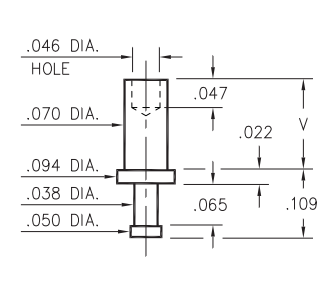

2355

2355-X-00-XX-00-00-07-0

Swage mount in .073 hole

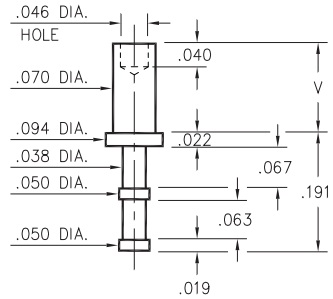

2365

2365-X-00-XX-00-00-07-0

Swage mount in .076 hole

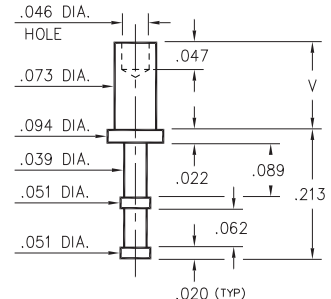

Basic Part Number	Board Thickness	Length V
23X5-1	.031	.053
23X5-2	.062	.084
23X5-3	.094	.115
23X5-4	.125	.147

SPECIFICATIONS:

Pin Material: Brass Alloy 360, 1/2 Hard
(Swage pins are annealed)

Dimensions: Inches

Tolerances On: Lengths: ±.005
Diameters: ±.002
Angles: ±2°



ORDER CODE: XXXX - X - 00 - XX - 00 - 00 - 07 - 0

BASIC PART #

SPECIFY PIN FINISH:

- 01 200 μ" TIN/LEAD OVER NICKEL
- ◆ 80 200 μ" TIN OVER NICKEL (RoHS)
- ◆ 44 300 μ" SILVER OVER COPPER (RoHS)
- 50 300 μ" ELECTRO-SOLDER (60/40 SnPb)



MALE PCB PINS

SOLDER TERMINAL TURRETS

2304

2304-X-00-XX-00-00-07-0

Swage mount in .076 hole

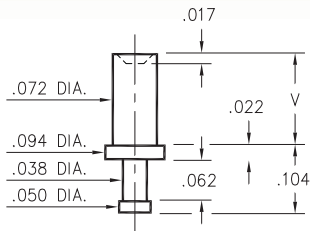

2305

2305-X-00-XX-00-00-07-0

Swage mount in .076 hole

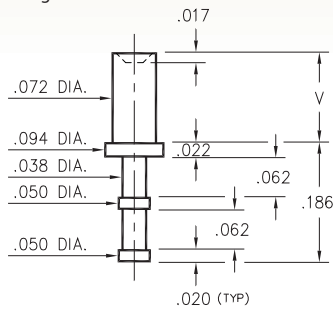

Basic Part Number	Board Thickness	Length V
230X-1	.031	.051
230X-2	.062	.082
230X-3	.094	.113
230X-4	.125	.145

2503

2503-X-00-XX-00-00-07-0

Swage mount in .082 hole

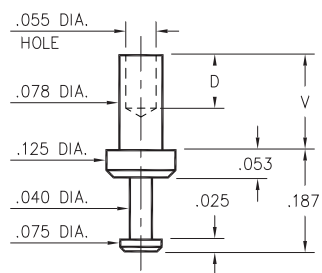

Basic Part Number	Board Thickness	Length V	Depth D
2503-1	.031	.078	.068
2503-2	.062	.109	.098
2503-3	.094	.141	.098
2503-4	.125	.172	.098

2704

2704-X-00-XX-00-00-07-0

Swage mount in .082 hole

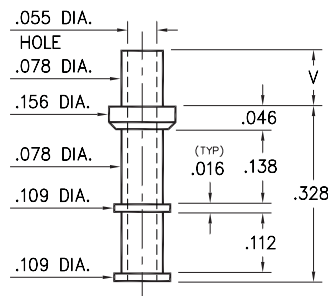

Basic Part Number	Board Thickness	Length V
2704-1	.031	.075
2704-2	.062	.105
2704-3	.094	.135
2704-4	.125	.165

2306

2306-X-00-XX-00-00-07-0

Swage mount in .076 hole

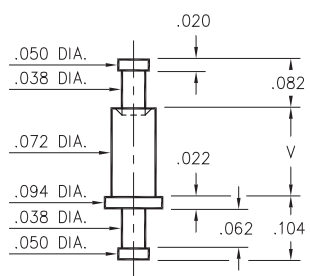

2307

2307-X-00-XX-00-00-07-0

Swage mount in .076 hole

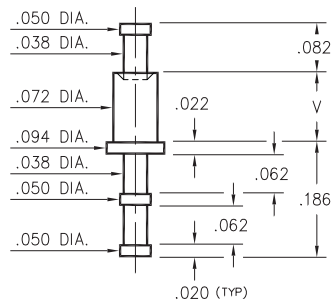

2311

2311-X-00-XX-00-00-07-0

Swage mount in .076 hole

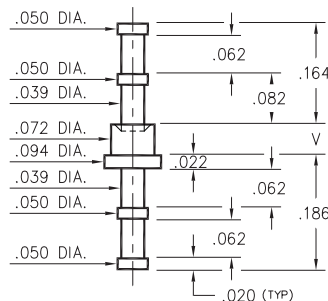

Basic Part Number	Board Thickness	Length V
23XX-1	.031	.051
23XX-2	.062	.082
23XX-3	.094	.113
23XX-4	.125	.145

SPECIFICATIONS:

Pin Material: Brass Alloy 360, 1/2 Hard
(Swage pins are annealed)

Dimensions: Inches

Tolerances On: Lengths: ±.005
Diameters: ±.002
Angles: ±2°



ORDER CODE: XXXX - X - 00 - XX - 00 - 00 - 07 - 0

BASIC PART #

SPECIFY PIN FINISH:

- 01 200 μ" TIN/LEAD OVER NICKEL
- ◆ 80 200 μ" TIN OVER NICKEL (RoHS)
- ◆ 44 300 μ" SILVER OVER COPPER (RoHS)
- 50 300 μ" ELECTRO-SOLDER (60/40 SnPb)



MALE PCB PINS

SOLDER TERMINAL TURRETS

2810

2810-X-00-XX-00-00-07-0

Swage mount in .118 hole

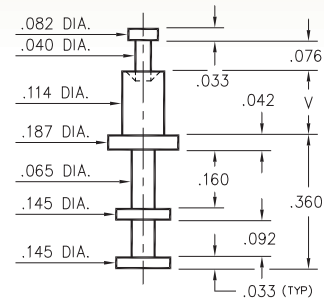

Basic Part Number	Board Thickness	Length V
2810-2	.062	.105
2810-3	.094	.135
2810-4	.125	.165

2524

2524-X-00-XX-00-00-07-0

Swage mount in .092 hole

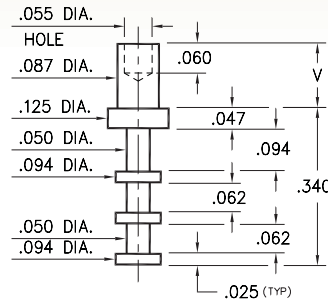

Basic Part Number	Board Thickness	Length V
2524-1	.031	.075
2524-2	.062	.105
2524-3	.094	.135
2524-4	.125	.165

2561

2561-X-00-XX-00-00-07-0

Swage mount in .094 hole

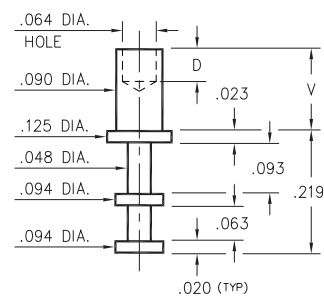

2508

2508-X-00-XX-00-00-07-0

Swage mount in .094 hole

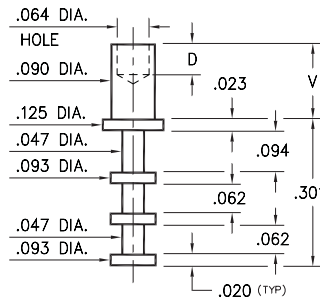

Basic Part Number	Board Thickness	Length V	Depth D
25XX-1	.031	.063	.047
25XX-2	.062	.094	.062
25XX-3	.094	.125	.062
25XX-4	.125	.156	.062

2551

2551-X-00-XX-00-00-07-0

Swage mount in .094 hole

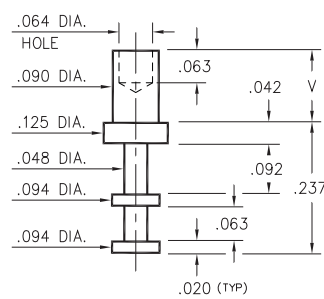

Basic Part Number	Board Thickness	Length V
2551-1	.031	.075
2551-2	.062	.105
2551-3	.094	.135
2551-4	.125	.165

2812

2812-X-00-XX-00-00-07-0

Swage mount in .116 hole

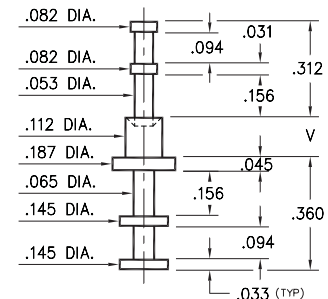

Basic Part Number	Board Thickness	Length V
2812-1	.062	.105
2812-2	.094	.135
2812-3	.125	.165
2812-4	.188	.230

SPECIFICATIONS:

Pin Material: Brass Alloy 360, 1/2 Hard
(Swage pins are annealed)

Dimensions: Inches

Tolerances On: Lengths: $\pm .005$
Diameters: $\pm .002$
Angles: $\pm 2^\circ$



ORDER CODE: **XXXX - X - 00 - XX - 00 - 00 - 07 - 0**

BASIC PART #

SPECIFY PIN FINISH:

- 01 200 μ " TIN/LEAD OVER NICKEL
- ◆ 80 200 μ " TIN OVER NICKEL (RoHS)
- ◆ 44 300 μ " SILVER OVER COPPER (RoHS)
- 50 300 μ " ELECTRO-SOLDER (60/40 SnPb)



MALE PCB PINS

SOLDER TERMINAL TURRETS

2501

2501-X-00-XX-00-00-07-0

Swage mount in .094 hole

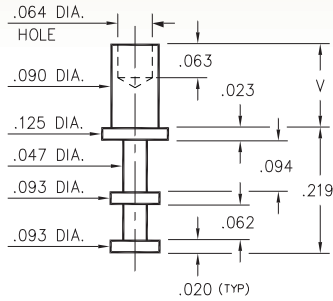

Basic Part Number	Board Thickness	Length V
2501-1	.031	.078
2501-2	.062	.109
2501-3	.094	.140
2501-4	.125	.171

2703

2703-X-00-XX-00-00-07-0

Swage mount in .094 hole

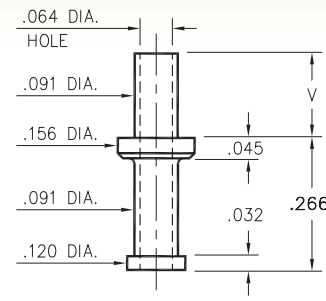

Basic Part Number	Board Thickness	Length V
2703-1	.031	.077
2703-2	.062	.107
2703-3	.094	.137
2703-4	.125	.167

2702

2702-X-00-XX-00-00-07-0

Swage mount in .094 hole

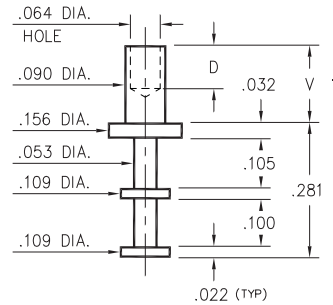

Basic Part Number	Board Thickness	Length V	Depth D
2702-1	.031	.075	.063
2702-2	.062	.105	.093
2702-3	.094	.135	.093
2702-4	.125	.165	.093

2710

2710-X-00-XX-00-00-07-0

Swage mount in .094 hole

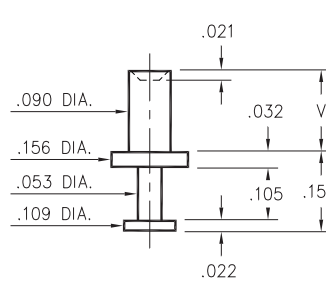

Basic Part Number	Board Thickness	Length V
2710-1	.031	.062
2710-2	.062	.094
2710-3	.094	.125
2710-4	.125	.156

2717

2717-X-00-XX-00-00-07-0

Swage mount in .094 hole

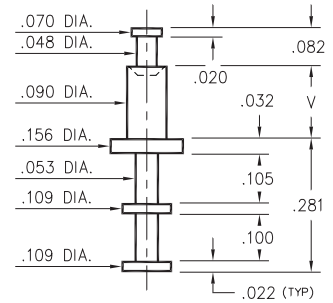

2713

2713-X-00-XX-00-00-07-0

Swage mount in .094 hole

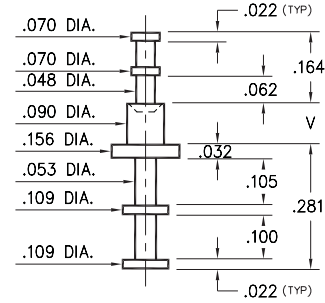

Basic Part Number	Board Thickness	Length V
271X-1	.031	.062
271X-2	.062	.094
271X-3	.094	.125
271X-4	.125	.156

SPECIFICATIONS:

Pin Material: Brass Alloy 360, 1/2 Hard
(Swage pins are annealed)

Dimensions: Inches

Tolerances On: Lengths: ±.005
Diameters: ±.002
Angles: ± 2°



ORDER CODE: XXXX - X - 00 - XX - 00 - 00 - 07 - 0

BASIC PART #

SPECIFY PIN FINISH:

- 01 200 μ" TIN/LEAD OVER NICKEL
- ◆ 80 200 μ" TIN OVER NICKEL (RoHS)
- ◆ 44 300 μ" SILVER OVER COPPER (RoHS)
- 50 300 μ" ELECTRO-SOLDER (60/40 SnPb)



MALE PCB PINS

SOLDER TERMINAL TURRETS

2512

2512-X-00-XX-00-00-07-0

Swage mount in .094 hole

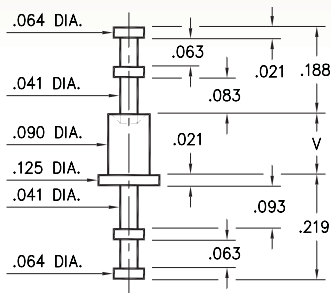

Basic Part Number	Board Thickness	Length V
2512-1	.031	.062
2512-2	.062	.094
2512-3	.094	.125
2512-4	.125	.156

2705

2705-X-00-XX-00-00-07-0

Swage mount in .129 hole

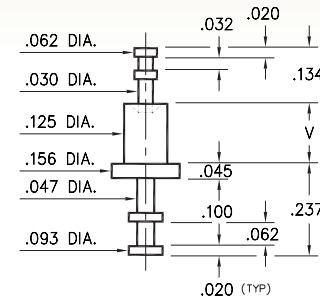

Basic Part Number	Board Thickness	Length V
2705-1	.031	.075
2705-2	.062	.105
2705-3	.094	.135
2705-4	.125	.165

2803

2803-X-00-XX-00-00-07-0

Swage mount in .113 hole

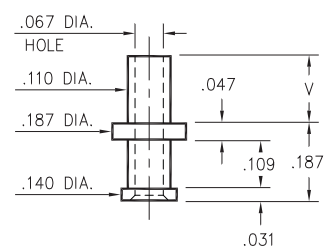

Basic Part Number	Board Thickness	Length V
2803-1	.031	.078
2803-2	.062	.109
2803-3	.094	.140
2803-4	.125	.171

2815

2815-X-00-XX-00-00-07-0

Swage mount in .113 hole

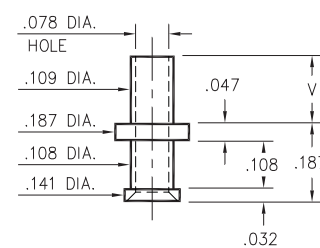

Basic Part Number	Board Thickness	Length V
2815-1	.031	.075
2815-2	.062	.105
2815-3	.094	.135
2815-4	.125	.165

2816

2816-X-00-XX-00-00-07-0

Swage mount in .116 hole

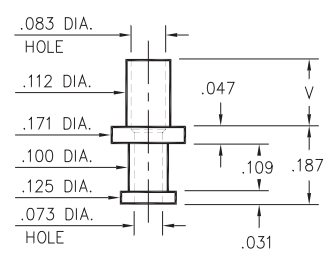

Basic Part Number	Board Thickness	Length V
2816-1	.031	.078
2816-2	.062	.109
2816-3	.094	.141
2816-4	.125	.172

2817

2817-X-00-XX-00-00-07-0

Swage mount in .116 hole

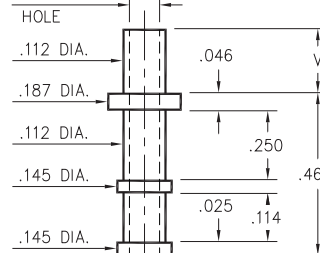

Basic Part Number	Board Thickness	Length V
2817-1	.031	.075
2817-2	.062	.105
2817-3	.094	.135
2817-4	.125	.165

SPECIFICATIONS:

Pin Material: Brass Alloy 360, 1/2 Hard
(Swage pins are annealed)

Dimensions: Inches

Tolerances On: Lengths: ±.005
Diameters: ±.002
Angles: ±2°



ORDER CODE: XXXX - X - 00 - XX - 00 - 00 - 07 - 0

BASIC PART #

SPECIFY PIN FINISH:

- 01 200 μ" TIN/LEAD OVER NICKEL
- ◆ 80 200 μ" TIN OVER NICKEL (RoHS)
- ◆ 44 300 μ" SILVER OVER COPPER (RoHS)
- 50 300 μ" ELECTRO-SOLDER
(60/40 SnPb)



MALE PCB PINS

SOLDER TERMINAL TURRETS

2802

2802-X-00-XX-00-00-07-0

Swage mount in .118 hole

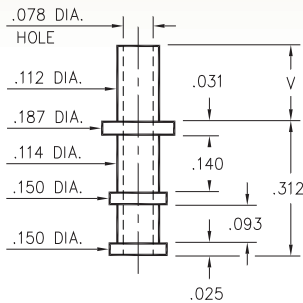

2804

2804-X-00-XX-00-00-07-0

Swage mount in .118 hole

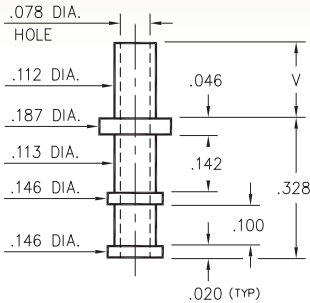

Basic Part Number	Board Thickness	Length V
280X-1	.031	.078
280X-2	.062	.109
280X-3	.094	.140
280X-4	.125	.171

2805

2805-X-00-XX-00-00-07-0

Swage mount in .116 hole

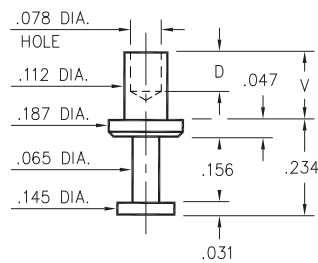

Basic Part Number	Board Thickness	Length V	Depth D
2805-1	.031	.074	.068
2805-2	.062	.105	.098
2805-3	.094	.135	.098
2805-4	.125	.165	.098

2801

2801-X-00-XX-00-00-07-0

Swage mount in .116 hole

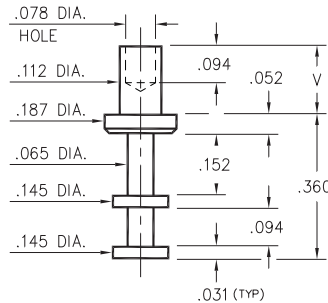

Basic Part Number	Board Thickness	Length V
2801-1	.031	.078
2801-2	.062	.109
2801-3	.094	.141
2801-4	.125	.172
2801-5	.188	.234

2806

2806-X-00-XX-00-00-07-0

Swage mount in .116 hole

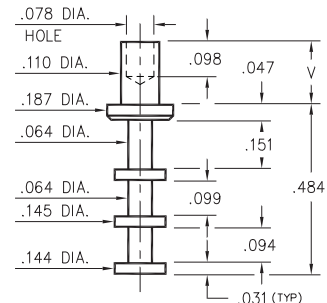

Basic Part Number	Board Thickness	Length V
2806-1	.031	.078
2806-2	.062	.109
2806-3	.094	.141
2806-4	.125	.172

2811

2811-X-00-XX-00-00-07-0

Swage mount in .116 hole

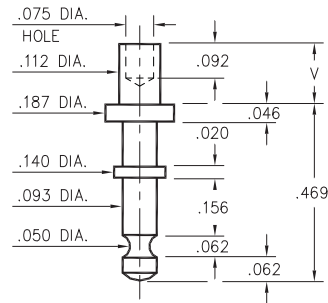

Basic Part Number	Board Thickness	Length V
2811-1	.031	.075
2811-2	.062	.105
2811-3	.094	.135
2811-4	.125	.165

SPECIFICATIONS:

Pin Material: Brass Alloy 360, 1/2 Hard
(Swage pins are annealed)

Dimensions: Inches

Tolerances On: Lengths: ±.005
Diameters: ±.002
Angles: ± 2°



ORDER CODE: XXXX - X - 00 - XX - 00 - 00 - 07 - 0

BASIC PART #

SPECIFY PIN FINISH:

- 01 200 μ" TIN/LEAD OVER NICKEL
- ◆ 80 200 μ" TIN OVER NICKEL (RoHS)
- ◆ 44 300 μ" SILVER OVER COPPER (RoHS)
- 50 300 μ" ELECTRO-SOLDER (60/40 SnPb)



MALE PCB PINS

SOLDER TERMINALS SLOTTED

2104

2104-X-01-XX-00-00-07-0

Swage mount in .036 hole

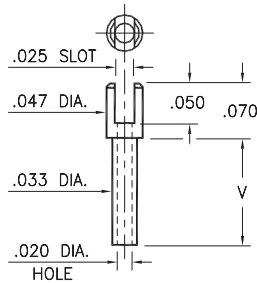

Basic Part Number	Board Thickness	Length V
2104-1	.031	.055
2104-2	.062	.086
2104-3	.094	.117
2104-4	.125	.148

2112

2112-X-01-XX-00-00-07-0

Swage mount in .043 hole

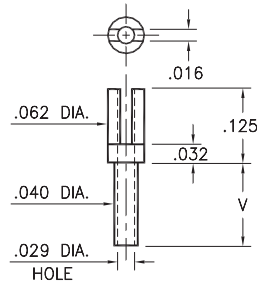

Basic Part Number	Board Thickness	Length V
2112-5	.016	.037
2112-1	.031	.053
2112-2	.062	.084
2112-3	.094	.115
2112-4	.125	.147

2105

2105-X-01-XX-00-00-07-0

Swage mount in .052 hole

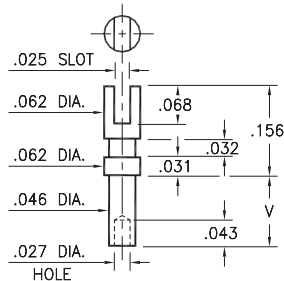

Basic Part Number	Board Thickness	Length V
2105-1	.031	.055
2105-2	.062	.086
2105-3	.094	.117
2105-4	.125	.149

2103

2103-X-01-XX-00-00-07-0

Swage mount in .052 hole

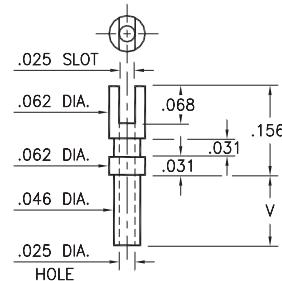

Basic Part Number	Board Thickness	Length V
2103-1	.031	.055
2103-2	.062	.086
2103-3	.094	.117
2103-4	.125	.149

2106

2106-X-01-XX-00-00-07-0

Swage mount in .052 hole

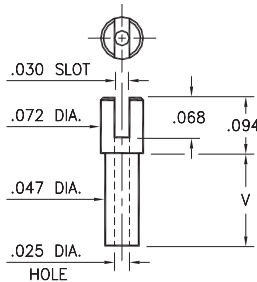

2107

2107-X-01-XX-00-00-07-0

Swage mount in .052 hole

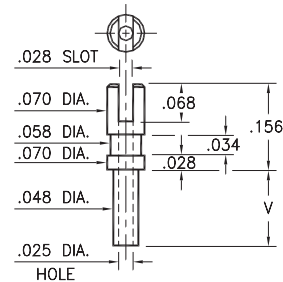

Basic Part Number	Board Thickness	Length V
210X-1	.031	.051
210X-2	.062	.082
210X-3	.094	.113
210X-4	.125	.145

6620

6620-0-35-XX-00-00-03-0

Solder mount in .064 mounting hole

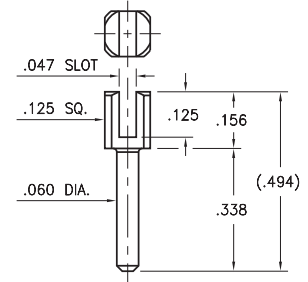

SPECIFICATIONS:

Pin Material: Brass Alloy 360, 1/2 Hard
(Swage pins are annealed)

Dimensions: Inches

Tolerances On: Lengths: $\pm .005$
Diameters: $\pm .002$
Angles: $\pm 2^\circ$



ORDER CODE: **XXXX - X - 01 - XX - 00 - 00 - 07 - 0**

BASIC PART #

SPECIFY PIN FINISH:

- 01 200 μ " TIN/LEAD OVER NICKEL
- ◆ 80 200 μ " TIN OVER NICKEL (RoHS)
- ◆ 44 300 μ " SILVER OVER COPPER (RoHS)
- 50 300 μ " ELECTRO-SOLDER (60/40 SnPb)



MALE PCB PINS

SOLDER TERMINALS SLOTTED

2303

2303-X-01-XX-00-00-07-0

Swage mount in .064 hole

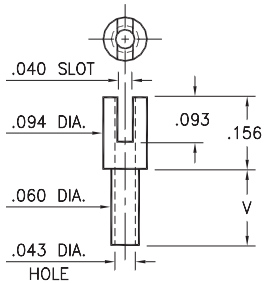

2323

2323-X-01-XX-00-00-07-0

Swage mount in .064 hole

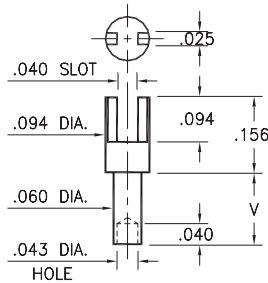

2322

2322-X-01-XX-00-00-07-0

Swage mount in .064 hole

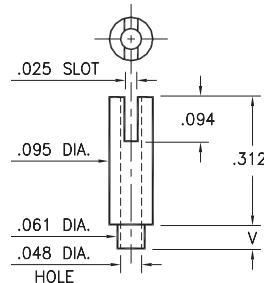

Basic Part Number	Board Thickness	Length V
23XX-1	.031	.053
23XX-2	.062	.084
23XX-3	.094	.115
23XX-4	.125	.147

2320

2320-X-01-XX-00-00-07-0

Swage mount in .064 hole

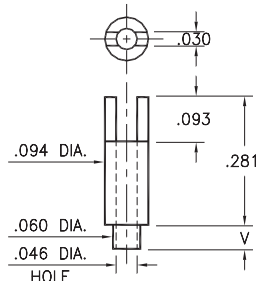

Basic Part Number	Board Thickness	Length V
2320-1	.031	.053
2320-2	.062	.084
2320-3	.094	.115

2328

2328-X-01-XX-00-00-07-0

Swage mount in .064 hole

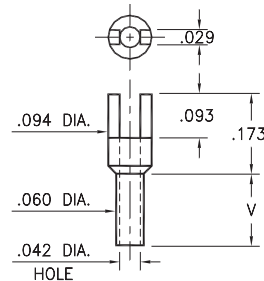

Basic Part Number	Board Thickness	Length V
2328-1	.031	.062
2328-2	.062	.094
2328-3	.094	.125
2328-4	.125	.156

2520

2520-X-01-XX-00-00-07-0

Swage mount in .064 hole

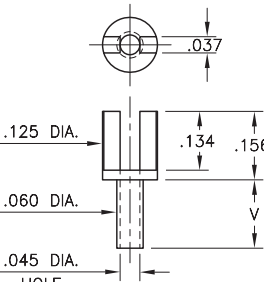

2517

2517-X-01-XX-00-00-07-0

Swage mount in .064 hole

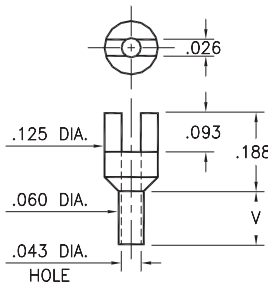

Basic Part Number	Board Thickness	Length V
25XX-1	.031	.062
25XX-2	.062	.094
25XX-3	.094	.125
25XX-4	.125	.156

SPECIFICATIONS:

Pin Material: Brass Alloy 360, 1/2 Hard
(Swage pins are annealed)

Dimensions: Inches

Tolerances On: Lengths: ±.005
Diameters: ±.002
Angles: ±2°



ORDER CODE: XXXX - X - 01 - XX - 00 - 00 - 07 - 0

BASIC PART # →

SPECIFY PIN FINISH:

- 01 200 μ" TIN/LEAD OVER NICKEL
- ◆ 80 200 μ" TIN OVER NICKEL (RoHS)
- ◆ 44 300 μ" SILVER OVER COPPER (RoHS)
- 50 300 μ" ELECTRO-SOLDER (60/40 SnPb)



WIRE TERMINATION

LOOSE PINS, RECEPTACLES AND SPRING PINS

Mill-Max manufactures many different types of pins and receptacles for terminating wires. There are solder cup and crimp barrel styles for terminating discrete wires to boards, making up cable assemblies or converting device wires to pluggable pins. We have slotted and turret styles for connecting power and ground wires or for test and jumper applications. Wrapost termination styles are also available for prototyping and test. Along with our wide selection of standard products, custom designs are available by contacting Mill-Max Technical Services.

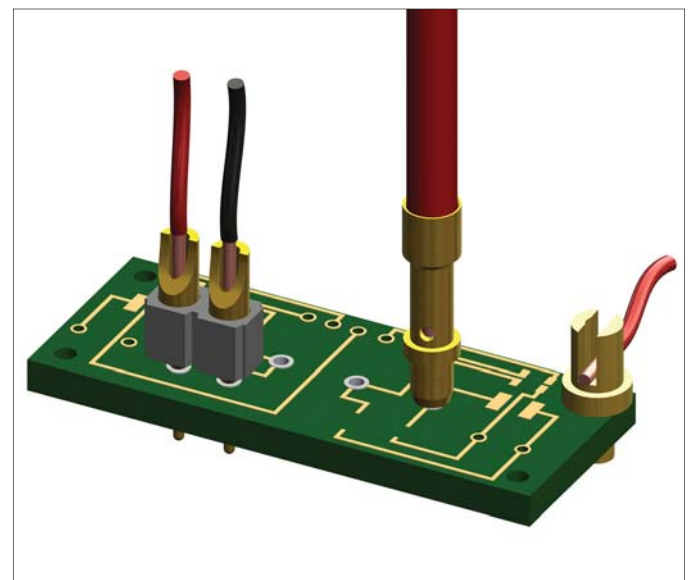
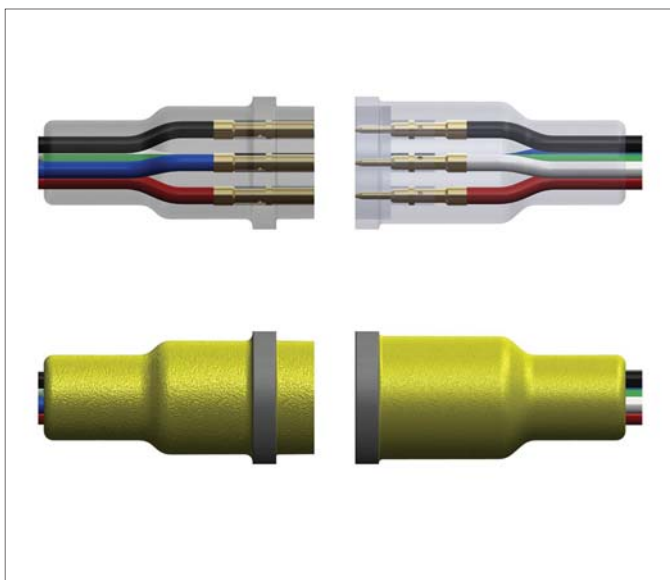
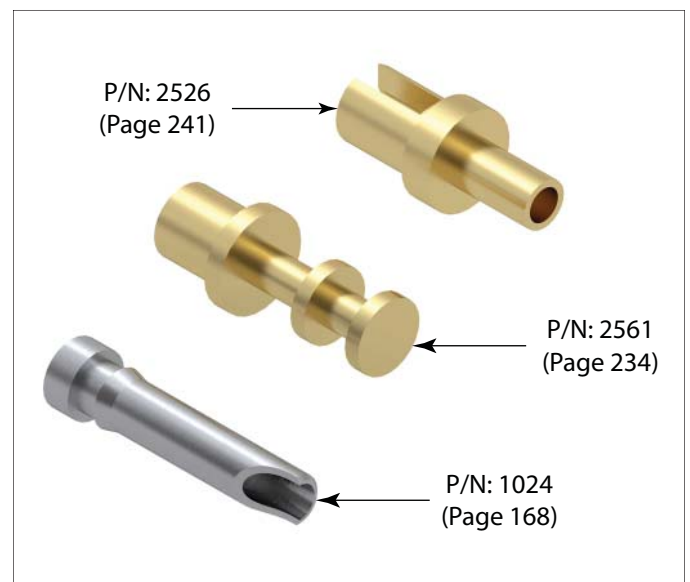
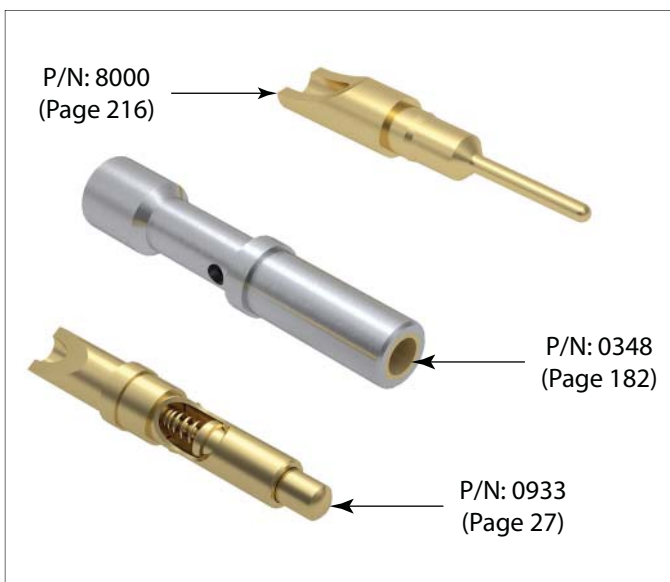

MALE PCB PINS

SOLDER TERMINALS SLOTTED

2315

2315-X-01-XX-00-00-07-0

Swage mount in .067 hole

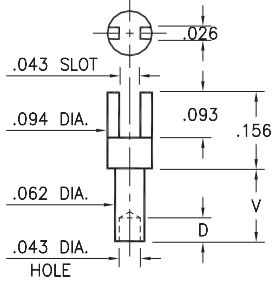

Basic Part Number	Board Thickness	Length V	Depth D
2315-1	.031	.045	.040
2315-2	.062	.094	.062
2315-3	.094	.125	.062
2315-4	.125	.156	.062

2302

2302-X-01-XX-00-00-07-0

Swage mount in .067 hole

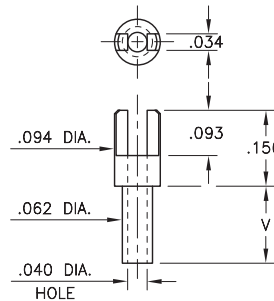

Basic Part Number	Board Thickness	Length V
2302-1	.031	.053
2302-2	.062	.084
2302-3	.094	.115
2302-4	.125	.147

2352

2352-X-01-XX-00-00-07-0

Swage mount in .067 hole

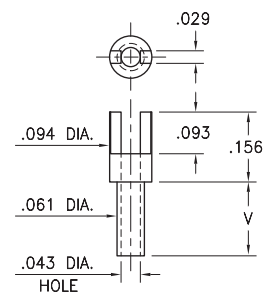

Basic Part Number	Board Thickness	Length V
2352-1	.031	.045
2352-2	.062	.094
2352-3	.094	.125
2352-4	.125	.156

2362

2362-X-01-XX-00-00-07-0

Swage mount in .067 hole

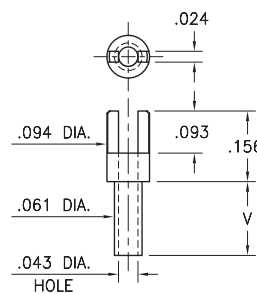

Basic Part Number	Board Thickness	Length V
2362-5	.016	.037
2362-1	.031	.053
2362-2	.062	.084
2362-3	.094	.115
2362-4	.125	.147

2507

2507-X-01-XX-00-00-07-0

Swage mount in .067 hole

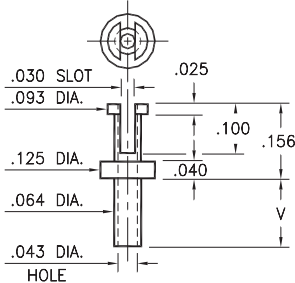

2526

2526-X-01-XX-00-00-07-0

Swage mount in .064 hole

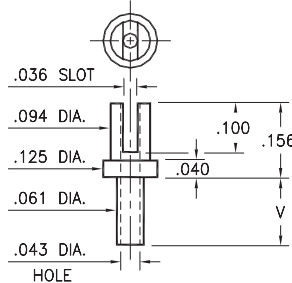

Basic Part Number	Board Thickness	Length V
25XX-1	.031	.053
25XX-2	.062	.084
25XX-3	.094	.115
25XX-4	.125	.147

SPECIFICATIONS:

Pin Material: Brass Alloy 360, 1/2 Hard
(Swage pins are annealed)

Dimensions: Inches

Tolerances On: Lengths: $\pm .005$
Diameters: $\pm .002$
Angles: $\pm 2^\circ$



ORDER CODE: XXXX - X - 01 - XX - 00 - 00 - 07 - 0

BASIC PART #

SPECIFY PIN FINISH:

- 01 200 μ " TIN/LEAD OVER NICKEL
- ◆ 80 200 μ " TIN OVER NICKEL (RoHS)
- ◆ 44 300 μ " SILVER OVER COPPER (RoHS)
- 50 300 μ " ELECTRO-SOLDER
(60/40 SnPb)



MALE PCB PINS

SOLDER TERMINALS SLOTTED

2314

2314-X-01-XX-00-00-07-0

Swage mount in .076 hole

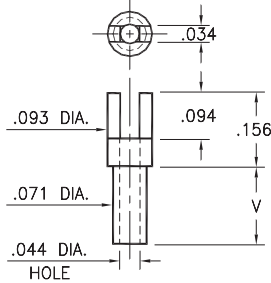

Basic Part Number	Board Thickness	Length V
2314-1	.031	.045
2314-2	.062	.094
2314-3	.094	.125
2314-4	.125	.156

2511

2511-X-01-XX-00-00-07-0

Swage mount in .076 hole

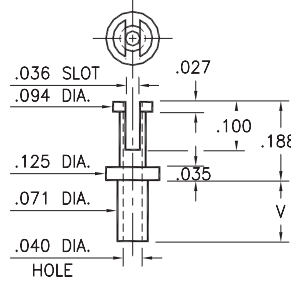

Basic Part Number	Board Thickness	Length V
2511-1	.031	.063
2511-2	.062	.094
2511-3	.094	.125
2511-4	.125	.156

2515

2515-X-01-XX-00-00-07-0

Swage mount in .094 hole

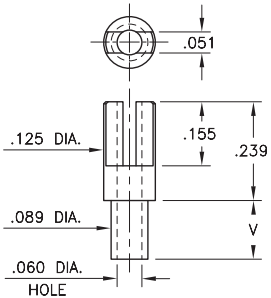

2516

2516-X-01-XX-00-00-07-0

Swage mount in .094 hole

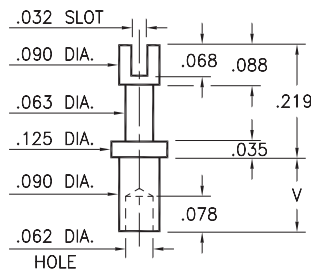

Basic Part Number	Board Thickness	Length V
251X-1	.031	.075
251X-2	.062	.105
251X-3	.094	.135
251X-4	.125	.147

2502

2502-X-01-XX-00-00-07-0

Swage mount in .094 hole

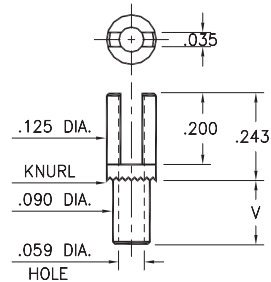

Basic Part Number	Board Thickness	Length V
2502-1	.031	.080
2502-2	.062	.111
2502-3	.094	.143
2502-4	.125	.174

SPECIFICATIONS:

Pin Material: Brass Alloy 360, 1/2 Hard
(Swage pins are annealed)

Dimensions: Inches

Tolerances On: Lengths: $\pm .005$
Diameters: $\pm .002$
Angles: $\pm 2^\circ$



ORDER CODE: XXXX - X - 01 - XX - 00 - 00 - 07 - 0

BASIC PART #

SPECIFY PIN FINISH:

- 01 200 μ m TIN/LEAD OVER NICKEL
- ◆ 80 200 μ m TIN OVER NICKEL (RoHS)
- ◆ 44 300 μ m SILVER OVER COPPER (RoHS)
- 50 300 μ m ELECTRO-SOLDER
(60/40 SnPb)



MALE PCB PINS

SOLDER TERMINALS SLOTTED

2715

2715-X-01-XX-00-00-07-0

Swage mount in .116 hole

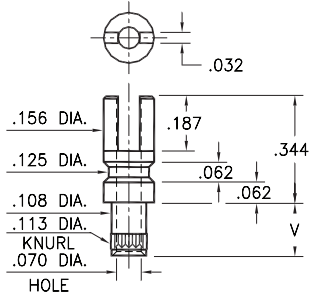

Basic Part Number	Board Thickness	Length V
2715-2	.062	.109
2715-3	.094	.141
2715-4	.125	.172

2809

2809-X-01-XX-00-00-07-0

Swage mount in .116 hole

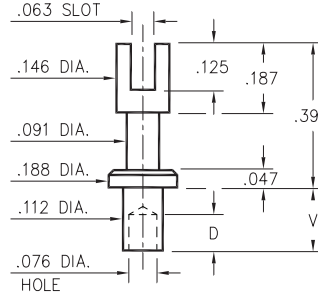

Basic Part Number	Board Thickness	Length V	Depth D
2809-1	.031	.078	.068
2809-2	.062	.109	.098
2809-3	.094	.141	.098
2809-4	.125	.172	.098

2701

2701-X-01-XX-00-00-07-0

Swage mount in .116 hole

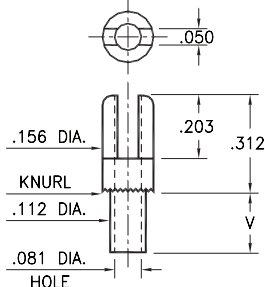

2808

2808-X-01-XX-00-00-07-0

Swage mount in .116 hole

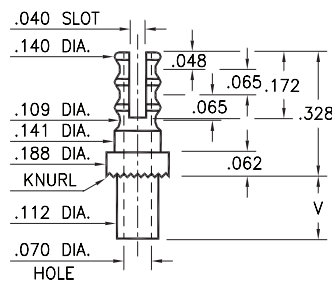

Basic Part Number	Board Thickness	Length V
2XXX-1	.031	.075
2XXX-2	.062	.105
2XXX-3	.094	.135
2XXX-4	.125	.165

2762

2762-4-01-XX-00-00-07-0

Swage mount in .116 hole
For a .125 thick board

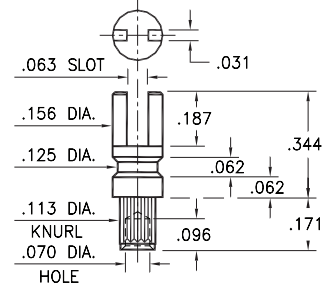

2807

2807-X-01-XX-00-00-07-0

Swage mount in .116 hole

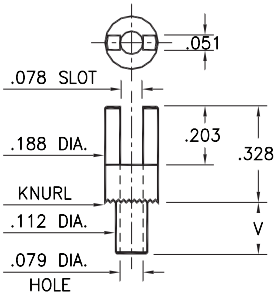

Basic Part Number	Board Thickness	Length V
2807-1	.031	.078
2807-2	.062	.109
2807-3	.094	.140
2807-4	.125	.171

3622

3622-0-32-15-00-00-03-0

Slotted compliant tail press-fit in .040 ± .003 plated hole. For .060" → .100" thick board

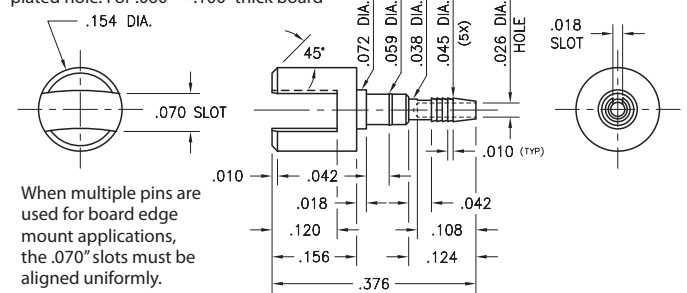

When multiple pins are used for board edge mount applications, the .070" slots must be aligned uniformly.

SPECIFICATIONS:

Pin Material: Brass Alloy 360, 1/2 Hard
(Swage pins are annealed)

Dimensions: Inches

Tolerances On: Lengths: ± .005
Diameters: ± .002
Angles: ± 2°



ORDER CODE: **XXXX - X - XX - XX - 00 - 00 - 07 - 0**

BASIC PART #

SPECIFY PIN FINISH:

Part #3622 plating ONLY

- 01 200 μ" TIN/LEAD OVER NICKEL
- 15 10 μ" GOLD OVER NICKEL (RoHS)
- 80 200 μ" TIN OVER NICKEL (RoHS)
- 44 300 μ" SILVER OVER COPPER (RoHS)
- 50 300 μ" ELECTRO-SOLDER (60/40 SnPb)



MALE PCB PINS

SOLDER TERMINALS VARIOUS TYPES

2709

2709-X-07-XX-00-00-07-0

Swage mount in .116 hole

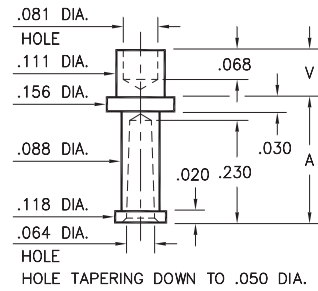

Basic Part Number	Board Thickness	Length V	Length A
2709-2	.062	.109	.281
2709-3	.094	.141	.250

2115

2115-2-00-XX-00-00-07-0

Swage mount in .043 hole
For a .062 thick board

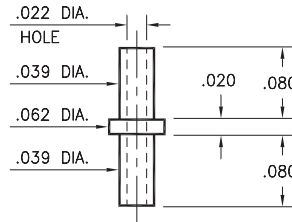

2326

2326-2-00-XX-00-00-07-0

Swage mount in .055 hole
For a .062 thick board

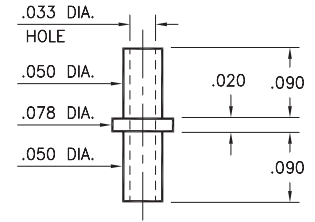

6430

6430-0-00-XX-00-00-03-0

Press-fit in .025 mounting hole

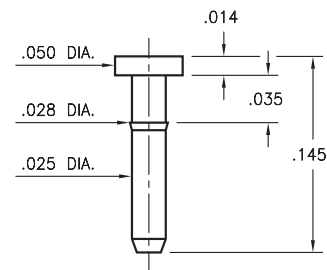

5731

5731-0-00-XX-00-00-03-0

Press-fit in .056 mounting hole

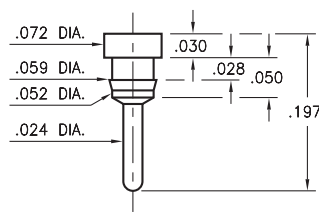

8831

8831-0-00-XX-00-00-03-0

Press-fit in .057 mounting hole

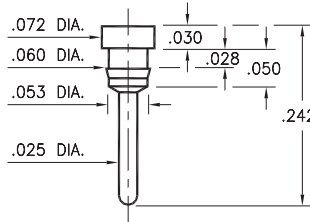

0995

0995-0-00-XX-00-00-03-0

Press-fit in .057 mounting hole

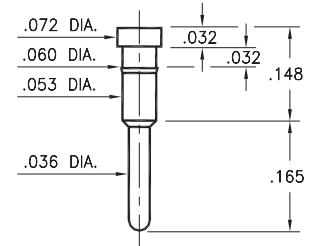

8835

8835-0-00-XX-00-00-03-0

Press-fit in .057 mounting hole

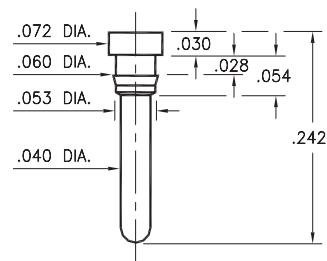

5130

5130-0-00-XX-00-00-03-0

Press-fit in .056 mounting hole

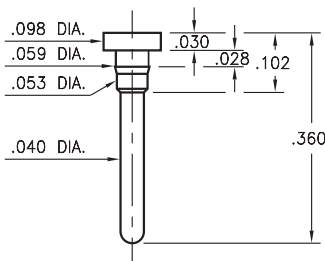

SPECIFICATIONS:

Pin Material: Brass Alloy 360, 1/2 Hard
(Swage pins are annealed)

Dimensions: Inches

Tolerances On: Lengths: ±.005
Diameters: ±.002
Angles: ± 2°



ORDER CODE: XXXX - X - XX - XX - 00 - 00 - XX - 0

BASIC PART #

SPECIFY PIN FINISH:

- 01 200 μ" TIN/LEAD OVER NICKEL
- ◆ 80 200 μ" TIN OVER NICKEL (RoHS)
- ◆ 44 300 μ" SILVER OVER COPPER (RoHS)
- 50 300 μ" ELECTRO-SOLDER (60/40 SnPb)



MALE PCB PINS

SOLDER TERMINALS PIN TYPE

2318

2318-X-00-XX-00-00-07-0

Swage mount in .062 hole

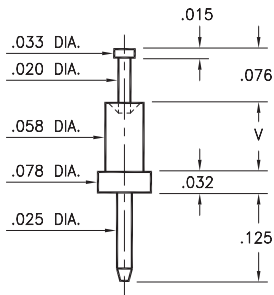

Basic Part Number	Board Thickness	Length V
2318-1	.031	.051
2318-2	.062	.082
2318-3	.094	.113

2309

2309-X-00-XX-00-00-07-0

Swage mount in .064 hole

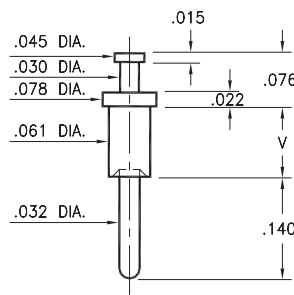

Basic Part Number	Board Thickness	Length V
2309-1	.031	.054
2309-2	.062	.084
2309-3	.094	.115
2309-4	.125	.147

2514

2514-2-00-XX-00-00-07-0

Press-fit in .070 mounting hole

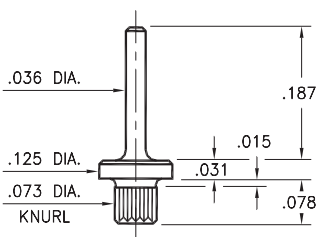

8602

8602-1-00-XX-00-00-07-0

Square press-fit in .032 plated through-hole

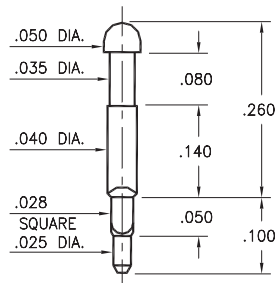

3050

3050-X-01-XX-00-00-03-0

Press-fit in .032 mounting hole
For wire sizes up to 26 AWG

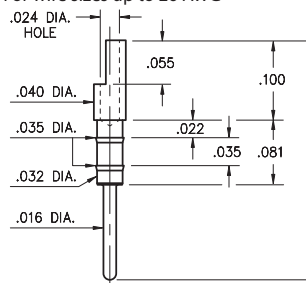

Basic Part Number	Pin Length A
3050-0	.303
3050-3	.376

8250

8250-0-00-XX-00-00-03-0

Press-fit in .034 mounting hole

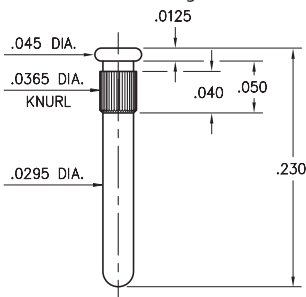

9994

9994-0-00-XX-00-00-03-0

Press-fit in .033 mounting hole

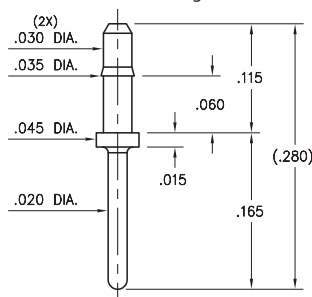

9067

9067-0-00-XX-00-00-03-0

Press-fit in .055 mounting hole

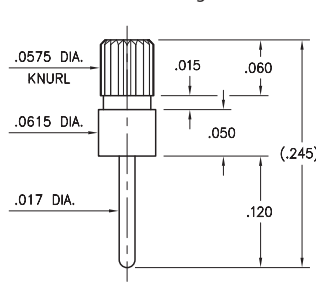

SPECIFICATIONS:

Pin Material: Brass Alloy 360, 1/2 Hard
(Swage pins are annealed)

Dimensions: Inches

Tolerances On: Lengths: ±.005
Diameters: ±.002
Angles: ±2°



ORDER CODE: XXXX - X - 00 - XX - 00 - 00 - 07 - 0

BASIC PART #

SPECIFY PIN FINISH:

- 01 200 μ" TIN/LEAD OVER NICKEL
- ◆ 80 200 μ" TIN OVER NICKEL (RoHS)
- ◆ 44 300 μ" SILVER OVER COPPER (RoHS)
- 50 300 μ" ELECTRO-SOLDER (60/40 SnPb)



MALE PCB PINS

SOLDER TERMINALS PIN TYPE

2319

2319-X-00-XX-00-00-07-0

Swage mount in .076 hole

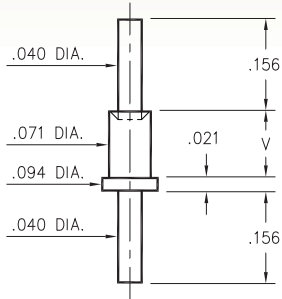

Basic Part Number	Board Thickness	Length V
2319-1	.031	.051
2319-2	.062	.082
2319-3	.094	.113

2313

2313-X-00-XX-00-00-07-0

Swage mount in .076 hole

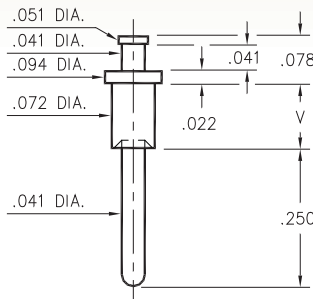

Basic Part Number	Board Thickness	Length V
2313-1	.031	.051
2313-2	.062	.084
2313-3	.094	.113
2313-4	.125	.145

2321

2321-X-00-XX-00-00-07-0

Swage mount in .076 hole

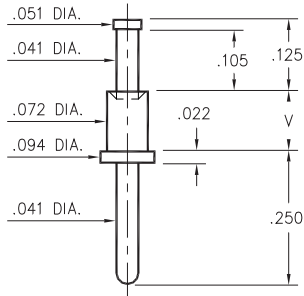

Basic Part Number	Board Thickness	Length V
2321-1	.031	.051
2321-2	.062	.082
2321-3	.094	.113
2321-4	.125	.145

2706

2706-X-00-XX-00-00-07-0

Swage mount in .120 hole

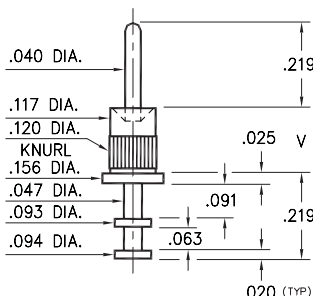

Basic Part Number	Board Thickness	Length V
2706-1	.031	.063
2706-2	.062	.093
2706-3	.094	.125
2706-4	.125	.156

2530

2530-X-00-XX-00-00-07-0

Swage mount in .094 hole

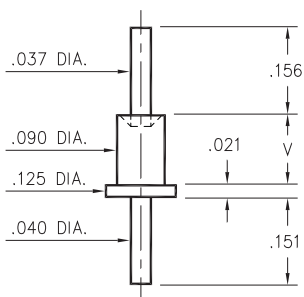

Basic Part Number	Board Thickness	Length V
2530-2	.062	.094
2530-3	.094	.125
2530-4	.125	.156

3156

3156-X-00-XX-00-00-08-0

Swage mount in .076 hole

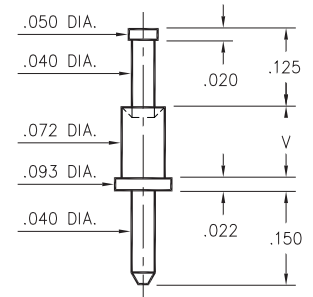

Basic Part Number	Board Thickness	Length V
3156-1	.031	.051
3156-2	.062	.082
3156-3	.094	.113
3156-4	.125	.145

SPECIFICATIONS:

Pin Material: Brass Alloy 360, 1/2 Hard
(Swage pins are annealed)

Dimensions: Inches

Tolerances On: Lengths: $\pm .005$
Diameters: $\pm .002$
Angles: $\pm 2^\circ$



ORDER CODE: XXXX - X - 00 - XX - 00 - 00 - XX - 0

BASIC PART #

SPECIFY PIN FINISH:

- 01 200 μ " TIN/LEAD OVER NICKEL
- ◆ 80 200 μ " TIN OVER NICKEL (RoHS)
- ◆ 44 300 μ " SILVER OVER COPPER (RoHS)
- 50 300 μ " ELECTRO-SOLDER
(60/40 SnPb)

