



WWW.MILL-MAX.COM

MALE PCB PINS





WWW.MILL-MAX.COM

MILL-MAX PRINTED CIRCUIT PINS ARE MACHINED INDIVIDUAL PINS USED FOR VARIOUS PLUG-IN APPLICATIONS AND ARE FUNCTIONALLY THE DYNAMIC BUILDING BLOCKS WITHIN AN INTERCONNECT SYSTEM.

Mill-Max offers a variety of pins in a broad range of diameters as well as turret, slotted, bifurcated (forked), soldercup and wrapost style pins. They are commonly fastened to printed circuit boards or other housings by being press-fit, swaged (riveted) or soldered.

PCB pins serve not only as a conductive path for an electrical circuit, but provide strength to an assembly module as a mechanical interface. Mill-Max Mfg. Corp. has developed thousands of state-of-the-art "basic pin" designs, featuring pin barrel geometries for our customers who require outside-the-box solutions to their interconnect needs.

In addition to the products found on the following pages, Mill-Max offers the following stock materials and diameters available for manufacture:

BRASS Alloy 360, 1/2 hard: 1,57/1,83/1,98/2,36/3,18/3,96/4,75/6,35 diameters

PHOSPHOR BRONZE Alloy 544: 1,57/1,83/1,98 diameters

TELLURIUM COPPER Alloy 145: 2,01/2,36/3,18/3,96 diameters

Mill-Max will gladly quote application specific products. Please complete the specification sheet on page **247** or send us your own drawings.

We assure you a fast response.

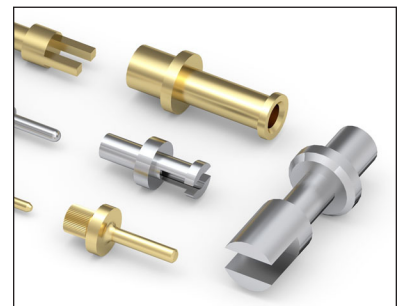
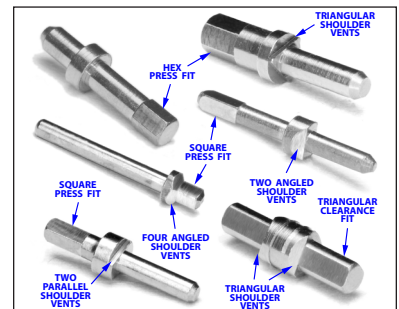
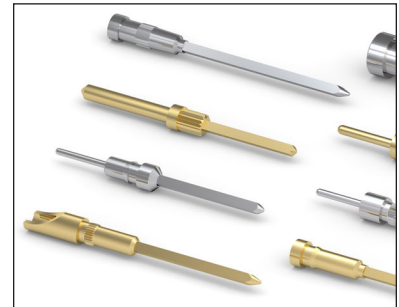
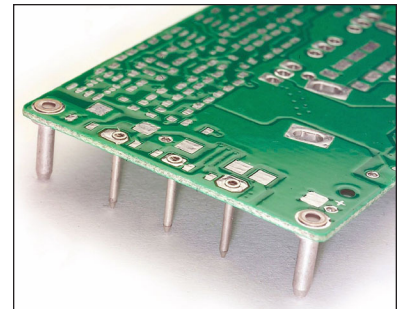

MALE PCB PINS

PRINTED CIRCUIT PINS • NAIL HEAD TYPE

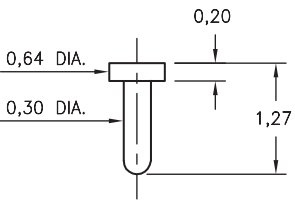
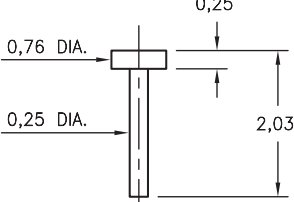
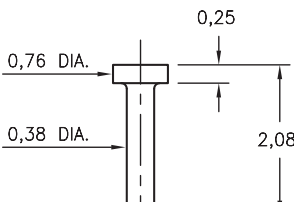
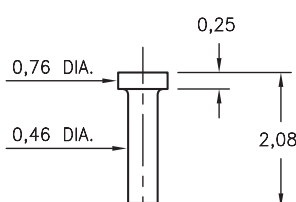
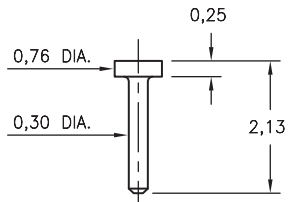
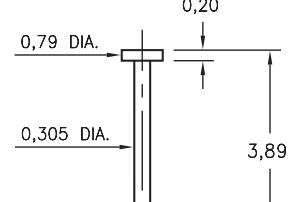
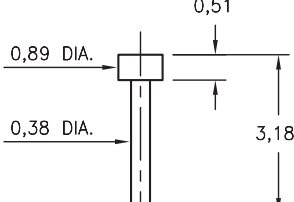
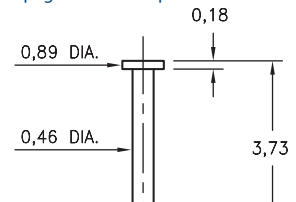
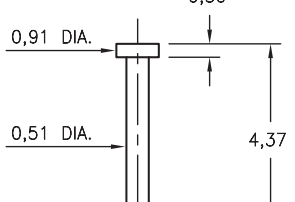
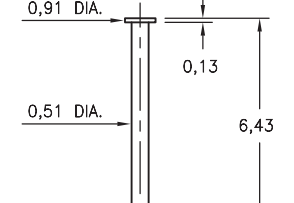
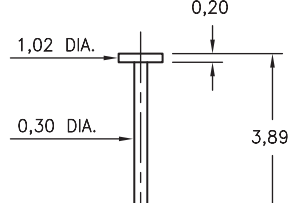
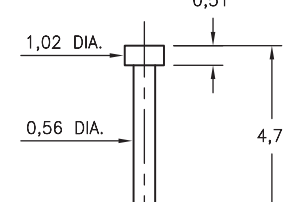
<p>9050 9050-0-00-XX-00-00-33-0 Solder mount in 0,41 mounting hole</p> 	<p>4184 4184-0-00-XX-00-00-33-0 Solder mount in 0,36 mounting hole</p> 	<p>4825 4825-0-00-XX-00-00-33-0 Solder mount in 0,48 mounting hole Also available on 16mm wide carrier tape: 3,250 parts per 330mm reel. See page 224.1 for Tape & Reel details</p> 	<p>4288 4288-0-00-XX-00-00-33-0 Solder mount in 0,56 mounting hole Also available on 16mm wide carrier tape: 3,250 parts per 330mm reel. See page 224.1 for Tape & Reel details</p> 
<p>4353 4353-0-00-XX-00-00-33-0 Solder mount in 0,41 mounting hole Also available on 16mm wide carrier tape: 3,040 parts per 330mm reel. See page 224.1 for Tape & Reel details</p> 	<p>6083 6083-0-00-XX-00-00-03-0 Solder mount in 0,41 mounting hole</p> 	<p>4689 4689-0-00-XX-00-00-33-0 Solder mount in 0,48 mounting hole</p> 	<p>4068 4068-0-00-XX-00-00-33-0 Solder mount in 0,56 mounting hole Also available on 16mm wide carrier tape: 2,000 parts per 330mm reel. See page 224.1 for Tape & Reel details</p> 
<p>5063 5063-0-00-XX-00-00-33-0 Solder mount in 0,61 mounting hole</p> 	<p>6547 6547-0-00-XX-00-00-33-0 Solder mount in 0,61 mounting hole Also available on 24mm wide carrier tape: 1,080 parts per 330mm reel. See page 224.1 for Tape & Reel details</p> 	<p>9083 9083-0-00-XX-00-00-38-0 Solder mount in 0,41 mounting hole Also available on 16mm wide carrier tape: 1,950 parts per 330mm reel. See page 224.1 for Tape & Reel details</p> 	<p>9185 9185-0-00-XX-00-00-33-0 Solder mount in 0,67 mounting hole</p> 

SPECIFICATIONS:

Pin Material: Brass Alloy 360, 1/2 Hard
(Except where noted)

Dimensions: Millimeters

Tolerances On: Lengths: $\pm 0,13$
Diameters: $\pm 0,051$
Angles: $\pm 2^\circ$



ORDER CODE: XXXX - X - 00 - XX - 00 - 00 - XX - 0

BASIC PART #

SPECIFY PIN FINISH:

- 01 5,08 μ m TIN/LEAD OVER NICKEL
- ◆ 80 5,08 μ m TIN OVER NICKEL (RoHS)
- ◆ 15 0,25 μ m GOLD OVER NICKEL (RoHS)
- ◆ 21 0,51 μ m GOLD OVER NICKEL (RoHS)
- ◆ 34 1,27 μ m GOLD OVER NICKEL (RoHS)



MALE PCB PINS

PRINTED CIRCUIT PINS • NAIL HEAD TYPE

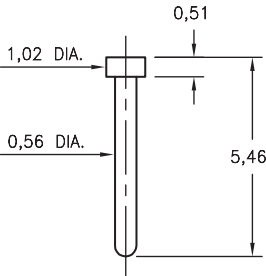
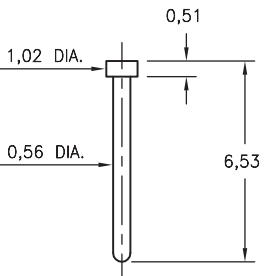
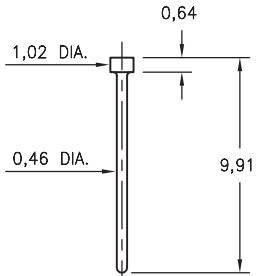
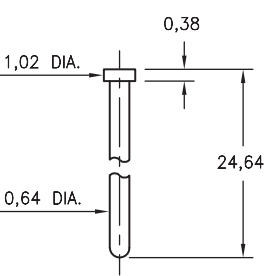
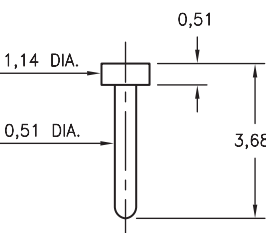
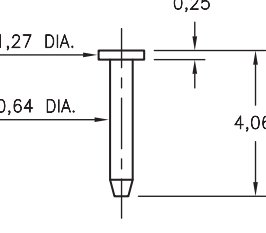
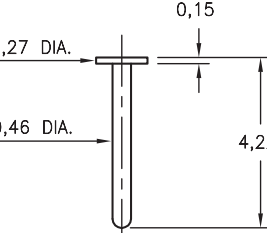
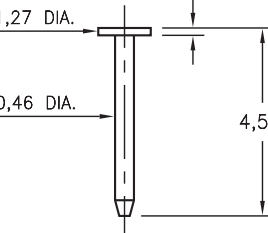
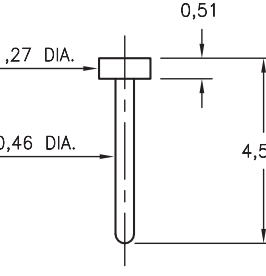
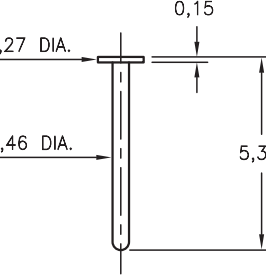
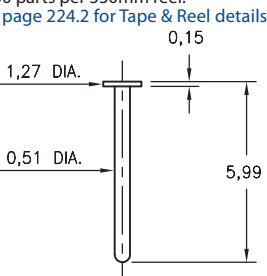
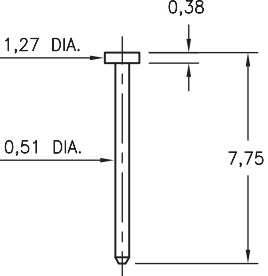
<p>8277 8277-0-00-XX-00-00-03-0 Solder mount in 0,66 mounting hole</p> 	<p>8257 8257-0-00-XX-00-00-33-0 Solder mount in 0,66 mounting hole</p> 	<p>4209 4209-0-00-XX-00-00-33-0 Solder mount in 0,56 mounting hole</p> 	<p>8451 8451-0-00-XX-00-00-33-0 Solder mount in 0,74 mounting hole</p> 
<p>5058 5058-0-00-XX-00-00-03-0 Solder mount in 0,61 mounting hole Also available on 16mm wide carrier tape: 2,000 parts per 330mm reel. See page 224.2 for Tape & Reel details</p> 	<p>5035 5035-0-00-XX-00-00-33-0 Solder mount in 0,74 mounting hole</p> 	<p>9113 9113-0-00-XX-00-00-38-0 Solder mount in 0,56 mounting hole Also available on 16mm wide carrier tape: 1,800 parts per 330mm reel. See page 224.2 for Tape & Reel details</p> 	<p>5068 5068-0-00-XX-00-00-03-0 Solder mount in 0,56 mounting hole</p> 
<p>9137 9137-0-00-XX-00-00-38-0 Solder mount in 0,56 mounting hole</p> 	<p>7113 7113-0-00-XX-00-00-03-0 Solder mount in 0,56 mounting hole</p> 	<p>4965 4965-0-00-XX-00-00-33-0 Solder mount in 0,61 mounting hole Also available on 24mm wide carrier tape: 1,300 parts per 330mm reel. See page 224.2 for Tape & Reel details</p> 	<p>4071 4071-0-00-XX-00-00-33-0 Solder mount in 0,61 mounting hole</p> 

SPECIFICATIONS:

Pin Material: Brass Alloy 360, 1/2 Hard
(Except where noted)

Dimensions: Millimeters

Tolerances On: Lengths: $\pm 0,13$
Diameters: $\pm 0,051$
Angles: $\pm 2^\circ$



ORDER CODE: XXXX - X - 00 - XX - 00 - 00 - XX - 0

BASIC PART #

SPECIFY PIN FINISH:

- 01 5,08 μ m TIN/LEAD OVER NICKEL
- ◆ 80 5,08 μ m TIN OVER NICKEL (RoHS)
- ◆ 15 0,25 μ m GOLD OVER NICKEL (RoHS)
- ◆ 21 0,51 μ m GOLD OVER NICKEL (RoHS)
- ◆ 34 1,27 μ m GOLD OVER NICKEL (RoHS)



MALE PCB PINS

PRINTED CIRCUIT PINS • NAIL HEAD TYPE

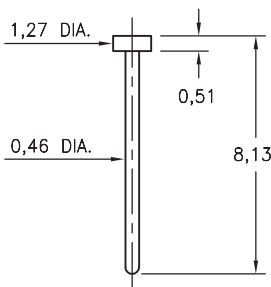
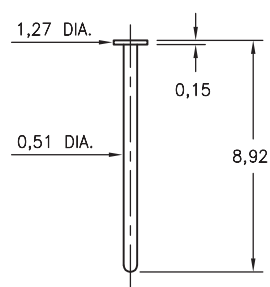
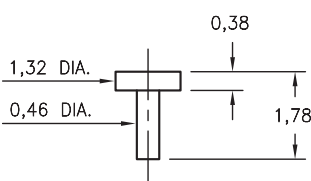
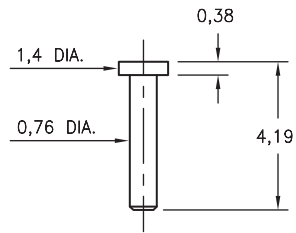
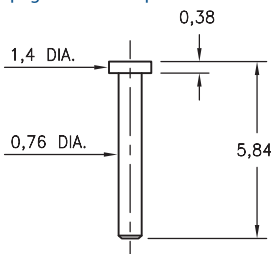
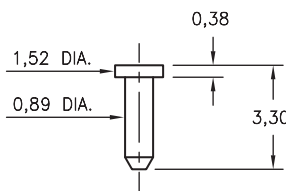
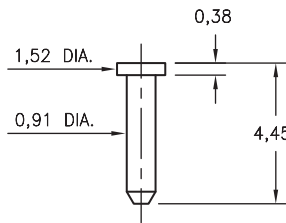
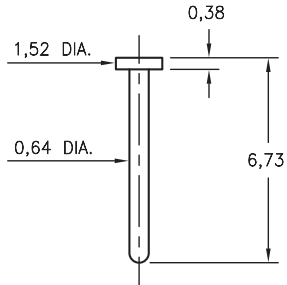
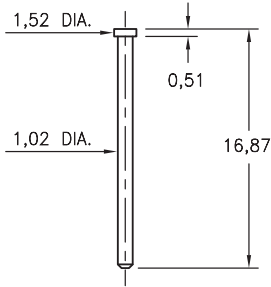
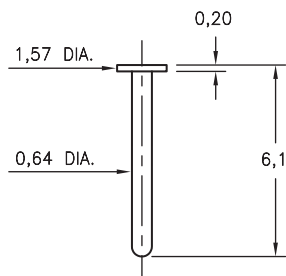
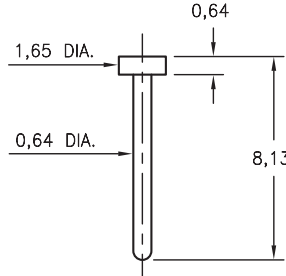
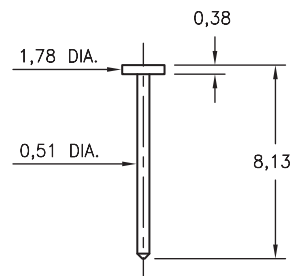
<p>5137 5137-0-00-XX-00-00-38-0 Solder mount in 0,56 mounting hole</p> 	<p>4964 4964-0-00-XX-00-00-33-0 Solder mount in 0,61 mounting hole</p> 	<p>4361 4361-0-00-XX-00-00-33-0 Solder mount in 0,56 mounting hole Also available on 16mm wide carrier tape: 3,600 parts per 330mm reel. See page 224.2 for Tape & Reel details</p> 	<p>6477 6477-0-00-XX-00-00-38-0 Solder mount in 0,86 mounting hole</p> 
<p>4477 4477-0-00-XX-00-00-33-0 Solder mount in 0,86 mounting hole Also available on 24mm wide carrier tape: 1,300 parts per 330mm reel. See page 224.2 for Tape & Reel details</p> 	<p>4268 4268-0-00-XX-00-00-33-0 Solder mount in 0,99 mounting hole</p> 	<p>9086 9086-0-00-XX-00-00-33-0 Solder mount in 1,02 mounting hole</p> 	<p>5850 5850-0-00-XX-00-00-03-0 Solder mount in 0,74 mounting hole</p> 
<p>1179 1179-0-00-XX-00-00-33-0 Solder mount in 1,12 mounting hole</p> 	<p>5240 5240-0-00-XX-00-00-33-0 Solder mount in 0,74 mounting hole</p> 	<p>6170 6170-0-00-XX-00-00-03-0 Solder mount in 0,74 mounting hole</p> 	<p>8808 8808-0-00-XX-00-00-33-0 Solder mount in 0,61 mounting hole</p> 

SPECIFICATIONS:

Pin Material: Brass Alloy 360, 1/2 Hard
(Except where noted)

Dimensions: Millimeters

Tolerances On: Lengths: $\pm 0,13$
Diameters: $\pm 0,051$
Angles: $\pm 2^\circ$



ORDER CODE: XXXX - X - 00 - XX - 00 - 00 - XX - 0

BASIC PART # \swarrow

SPECIFY PIN FINISH:

- 01** 5,08 μ m TIN/LEAD OVER NICKEL
- 80** 5,08 μ m TIN OVER NICKEL (RoHS)
- 15** 0,25 μ m GOLD OVER NICKEL (RoHS)
- 21** 0,51 μ m GOLD OVER NICKEL (RoHS)
- 34** 1,27 μ m GOLD OVER NICKEL (RoHS)



MALE PCB PINS

PRINTED CIRCUIT PINS • NAIL HEAD TYPE

8330

8330-0-00-XX-00-00-38-0
Solder mount in 1,12 mounting hole
Also available on 24mm wide carrier tape:
610 parts per 330mm reel.
See page 224.3 for Tape & Reel details

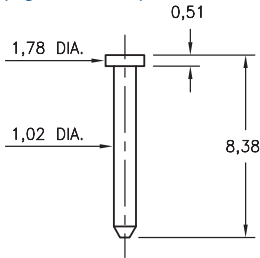

6599

6599-0-00-XX-00-00-03-0
Solder mount in 0,61 mounting hole

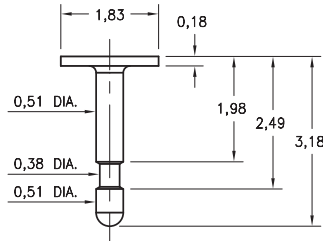

9265

9265-0-00-XX-00-00-38-0
Solder mount in 1,6 mounting hole
Also available on 16mm wide carrier tape:
1,170 parts per 330mm reel.
See page 224.3 for Tape & Reel details

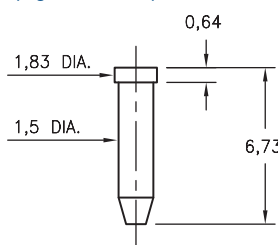

2650

2650-0-00-XX-00-00-33-0
Solder mount in 0,74 mounting hole

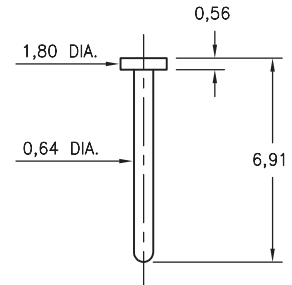

9872

9872-0-00-XX-00-00-33-0
Solder mount in 1,24 mounting hole

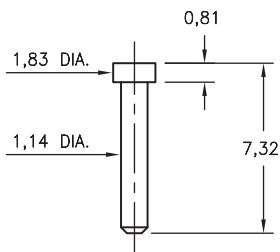

9228

9228-0-00-XX-00-00-38-0
Solder mount in 1,12 mounting hole

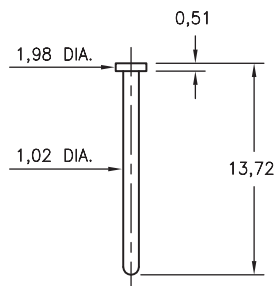

6095

6095-X-00-XX-00-00-38-0
Solder mount in 1,12 mounting hole

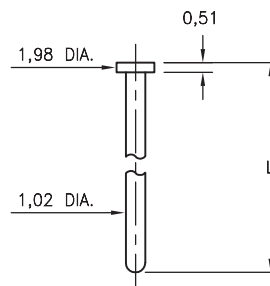

Basic Part Number	Length L
6095-0	14,73
6095-1	12,07

6092

6092-0-00-XX-00-00-33-0
Solder mount in 1,12 mounting hole

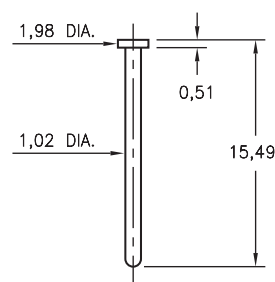

5909

5909-0-00-XX-00-00-03-0
Solder mount in 1,12 mounting hole

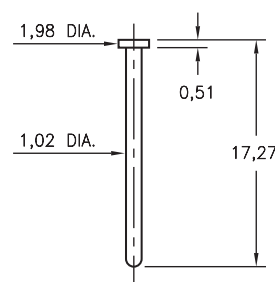

2381

2381-0-00-XX-00-00-33-0
Solder mount in 1,37 mounting hole
Also available on 16mm wide carrier tape:
1,800 parts per 330mm reel.
See page 224.3 for Tape & Reel details

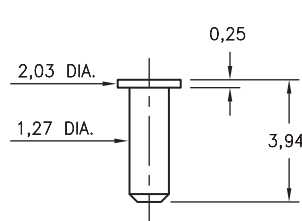

5062

5062-0-00-XX-00-00-33-0
Solder mount in 0,74 mounting hole

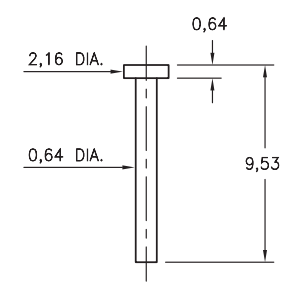

SPECIFICATIONS:

Pin Material: Brass Alloy 360, 1/2 Hard
(Except where noted)

Dimensions: Millimeters

Tolerances On: Lengths: $\pm 0,13$
Diameters: $\pm 0,051$
Angles: $\pm 2^\circ$



ORDER CODE: XXXX - 0 - 00 - XX - 00 - 00 - XX - 0

BASIC PART # →

SPECIFY PIN FINISH:

- 01** 5,08 μ m TIN/LEAD OVER NICKEL
- ◆ **80** 5,08 μ m TIN OVER NICKEL (RoHS)
- ◆ **15** 0,25 μ m GOLD OVER NICKEL (RoHS)
- ◆ **21** 0,51 μ m GOLD OVER NICKEL (RoHS)
- ◆ **34** 1,27 μ m GOLD OVER NICKEL (RoHS)



MALE PCB PINS

PRINTED CIRCUIT PINS

4541

4541-0-00-XX-00-00-03-0

Solder mount in 0,56 mounting hole

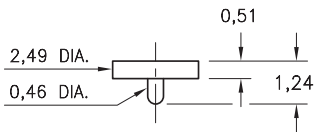

6142

6142-0-00-XX-00-00-33-0

Solder mount in 1,63 mounting hole

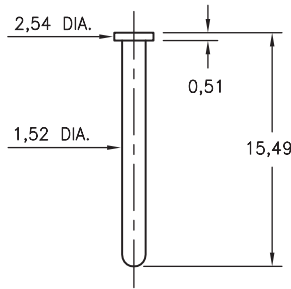

5910

5910-0-00-XX-00-00-03-0

Solder mount in 2,13 mounting hole

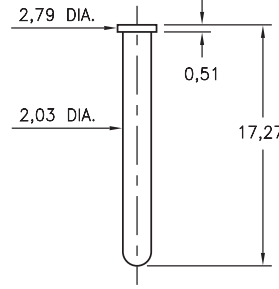

9022

9022-0-00-XX-00-00-33-0

Solder mount in 1,68 mounting hole
Also available on 24mm wide carrier tape:
1,500 parts per 330mm reel.
See page 224.4 for Tape & Reel details

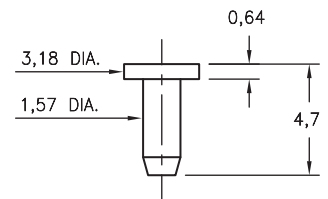

8086

8086-0-00-XX-00-00-33-0

Solder mount in 2,01 mounting hole
Also available on 12mm wide carrier tape:
550 parts per 330mm reel.
See page 224.4 for Tape & Reel details

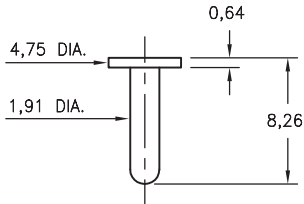

8086

8086-0-00-XX-00-00-33-0

Surface mount
Also available on 24mm wide carrier tape:
450 parts per 330mm reel.
See page 224.4 for Tape & Reel details

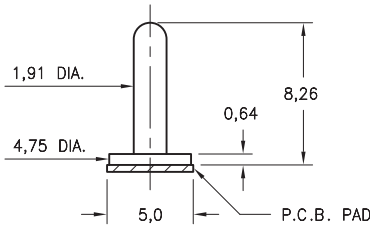

P.C.B. Layout

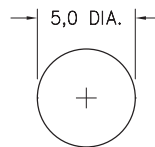

SPECIFICATIONS:

Pin Material: Brass Alloy 360, 1/2 Hard
(Except where noted)

Dimensions: Millimeters

Tolerances On: Lengths: $\pm .005$
Diameters: $\pm .002$
Angles: $\pm 2^\circ$



ORDER CODE: XXXX - X - 00 - XX - 00 - 00 - XX - 0

BASIC PART #

SPECIFY PIN FINISH:

- 01 200 μ m TIN/LEAD OVER NICKEL
- ◆ 80 200 μ m TIN OVER NICKEL (RoHS)
- ◆ 15 10 μ m GOLD OVER NICKEL (RoHS)
- ◆ 21 20 μ m GOLD OVER NICKEL (RoHS)
- ◆ 34 50 μ m GOLD OVER NICKEL (RoHS)

MALE PCB PINS

STRAIGHT AND RIGHT ANGLE PINS

3320

3320-X-00-XX-00-00-03-0

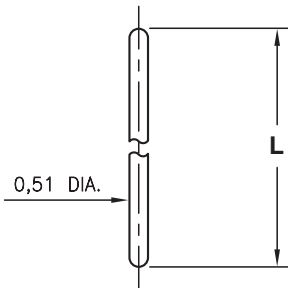

Basic Part Number	Length L
3320-0	6,35
3320-1	12,7

3325/6527

XXXX-X-00-XX-00-00-03-0

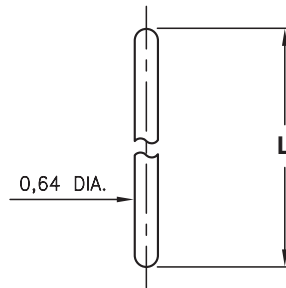

Basic Part Number	Length L
3325-0	6,35
3325-1	12,7
3325-2	19,05
6527-0	10,67

3330

3330-X-00-XX-00-00-03-0

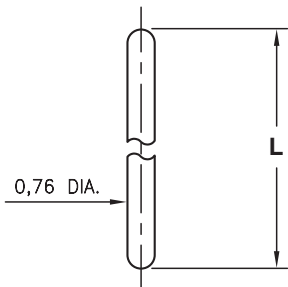

Basic Part Number	Length L
3330-0	6,35
3330-1	12,7
3330-2	19,05

3340

3340-X-00-XX-00-00-03-0

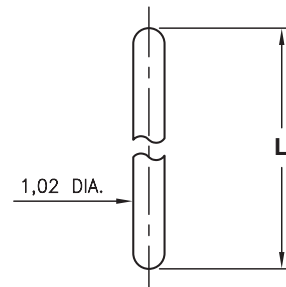

Basic Part Number	Length L
3340-0	6,35
3340-1	12,7
3340-2	19,05

3560

3560-X-00-XX-00-00-03-0

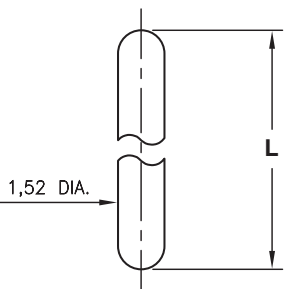

Basic Part Number	Length L
3560-0	6,35
3560-1	12,7
3560-2	19,05

3580

3580-X-00-XX-00-00-03-0

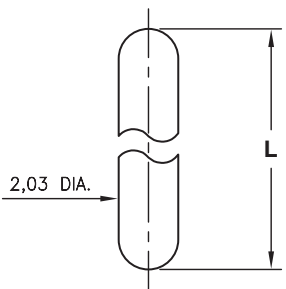

Basic Part Number	Length L
3580-0	6,35
3580-1	12,7
3580-2	19,05

SPECIFICATIONS:

Pin Material: Brass Alloy 360, 1/2 Hard
(Except where noted)

Dimensions: Millimeters

Tolerances On: Lengths: $\pm 0,13$
Diameters: $\pm 0,051$
Angles: $\pm 2^\circ$



ORDER CODE: XXXX - X - 00 - XX - 00 - 00 - 03 - 0

BASIC PART #

SPECIFY PIN FINISH:

- ◆ 80 5,08 μ m TIN OVER NICKEL (RoHS)
- ◆ 15 0,25 μ m GOLD OVER NICKEL (RoHS)



MALE PCB PINS

RIGHT ANGLE PINS

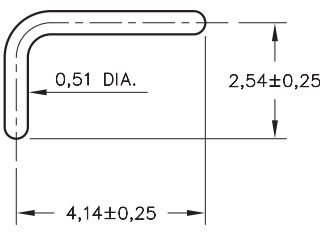
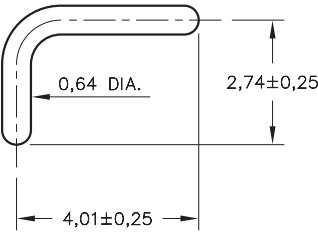
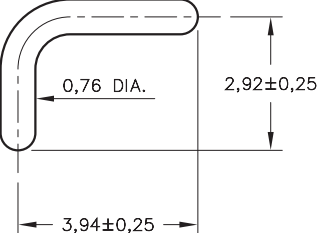
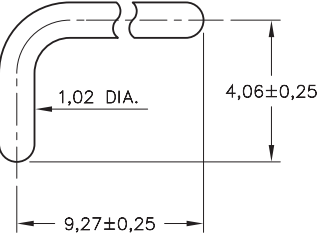
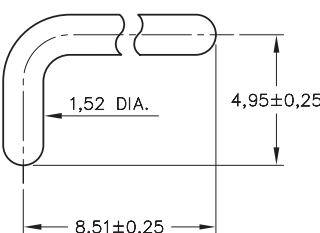
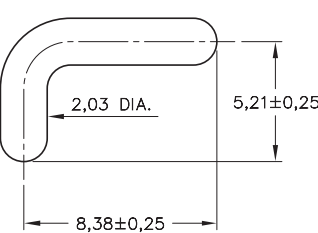
<p>3720 3720-0-14-XX-00-00-03-0 Right Angle Bent Pin</p> 	<p>3725 3725-0-14-XX-00-00-03-0 Right Angle Bent Pin</p> 	<p>3730 3730-0-14-XX-00-00-03-0 Right Angle Bent Pin</p> 	<p>3740 3740-0-14-XX-00-00-03-0 Right Angle Bent Pin</p> 
<p>3760 3760-0-14-XX-00-00-03-0 Right Angle Bent Pin</p> 	<p>3780 3780-0-14-XX-00-00-03-0 Right Angle Bent Pin</p> 		

SPECIFICATIONS:

Pin Material: Brass Alloy 360, 1/2 Hard
(Except where noted)

Dimensions: Millimeters

Tolerances On: Lengths: $\pm .005$
Diameters: $\pm .002$
Angles: $\pm 2^\circ$



ORDER CODE: 37XX - X - 00 - XX - 00 - 00 - 03 - 0

BASIC PART #

SPECIFY PIN FINISH:

- ◆ 80 5,08 μ m TIN OVER NICKEL (RoHS)
- ◆ 15 0,25 μ m GOLD OVER NICKEL (RoHS)



MALE PCB PINS

PRINTED CIRCUIT PINS

4006

4006-X-00-XX-00-00-03-0

Hex press-fit in 0,86 mounting hole

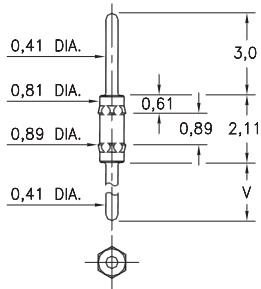

Basic Part Number	Length V
4006-0	3,0
4006-1	4,78
4006-2	7,32

3121

3121-X-00-XX-00-00-08-0

Solder mount in 0,58 mounting hole
Material is annealed.

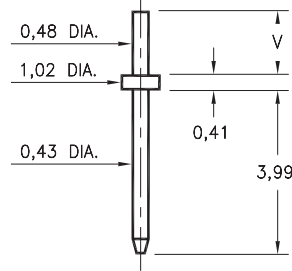

Basic Part Number	Substrate Thickness	Length V
3121-1	0,64	1,55
3121-2	1,02	1,91

3128

3128-X-00-XX-00-00-08-0

Solder mount in 0,61 min. mounting hole

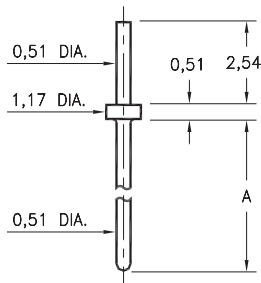

Basic Part Number	Length A
3128-1	6,35
3128-2	10,8
3128-3	13,34
3128-4	14,22
3128-5	23,62

3006

3006-0-00-XX-00-00-03-0

Press-fit in 0,86 mounting hole

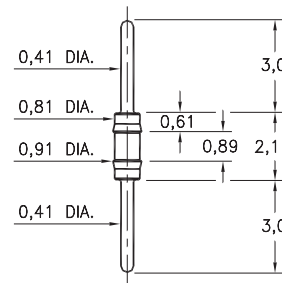

8885

8885-0-00-XX-00-00-03-0

Press-fit in 1,45 mounting hole

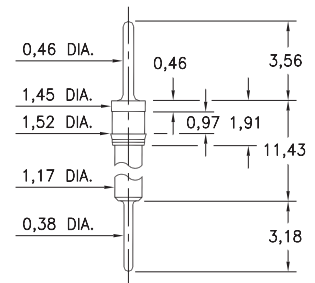

6218

6218-0-00-XX-00-00-03-0

Press-fit in 1,45 mounting hole

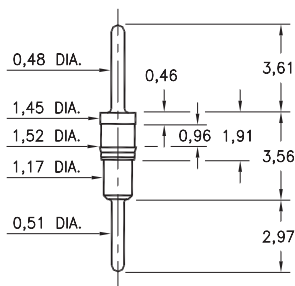

5012

5012-0-00-XX-00-00-03-0

Press-fit in 1,45 mounting hole

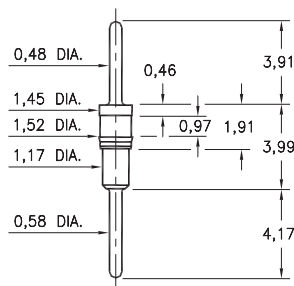

9081

9081-0-00-XX-00-00-08-0

Solder mount in 0,61 mounting hole

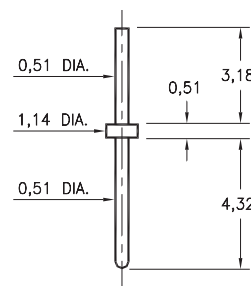

3039

3039-0-00-15-00-00-03-0

Press-fit in .025 mounting hole

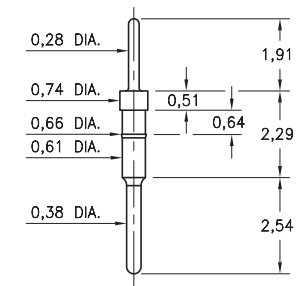

SPECIFICATIONS:

Pin Material: Brass Alloy 360, 1/2 Hard
(Except where noted)

Dimensions: Millimeters

Tolerances On: Lengths: $\pm 0,13$
Diameters: $\pm 0,051$
Angles: $\pm 2^\circ$



ORDER CODE: XXXX - X - 00 - XX - 00 - 00 - XX - 0

BASIC PART #

SPECIFY PIN FINISH:

- 01 5,08 μ m TIN/LEAD OVER NICKEL
- ◆ 80 5,08 μ m TIN OVER NICKEL (RoHS)
- ◆ 15 0,25 μ m GOLD OVER NICKEL (RoHS)
- ◆ 21 0,51 μ m GOLD OVER NICKEL (RoHS)
- ◆ 34 1,27 μ m GOLD OVER NICKEL (RoHS)



MALE PCB PINS

PRINTED CIRCUIT PINS

5421

5421-0-00-XX-00-00-03-0

Solder mount in 0,58 or 0,53 mounting hole

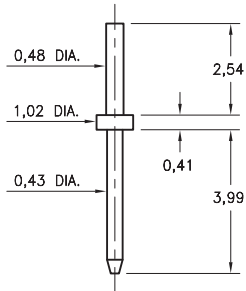

7069

7069-0-00-XX-00-00-03-0

Solder mount in 1,12 or 0,61 mounting hole

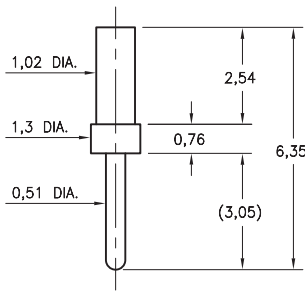

5247

5247-0-00-XX-00-00-03-0

Solder mount in 0,89 mounting hole

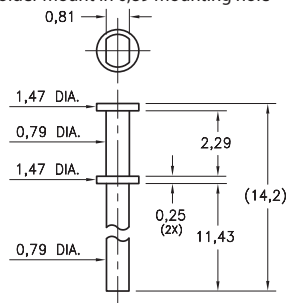

6136

6136-0-00-XX-00-00-03-0

Solder mount in 1,12 or 0,86 mounting hole

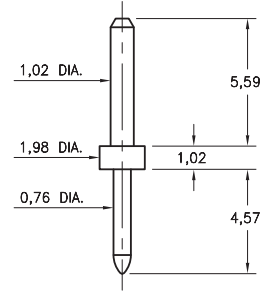

0912/7912

X912-0-00-XX-00-00-03-0

Press-fit in 1,45 mounting hole

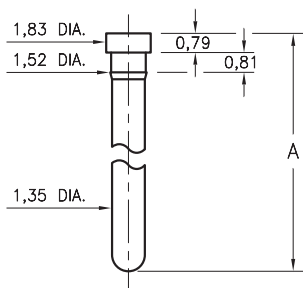

Basic Part Number	Pin Length A
0912-0	7,95
7912-0	12,95

8836

8836-0-00-XX-00-00-03-0

Press-fit in 1,91 mounting hole

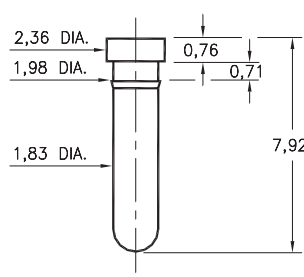

6298

6298-0-00-XX-00-00-03-0

Press-fit in 2,11 mounting hole

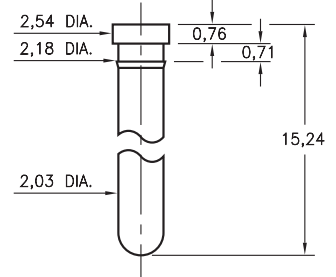

1130

1130-0-00-XX-00-00-03-0

Press-fit in 1,45 mounting hole
Pin material is Phosphor Bronze 544 (B2)

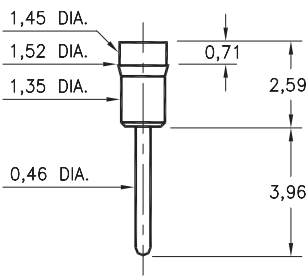

6711

6711-0-00-XX-00-00-03-0

Solder mount in 1,09 mounting hole

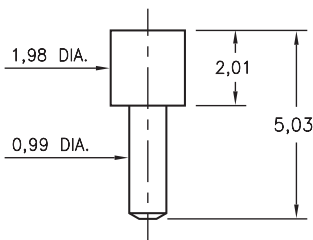

1980

1980-0-00-00-XX-00-03-0

Surface mount, Target Connector
Also available on carrier tape: 1,450 parts per 330mm reel. Order as: 319-10-1XX-40-080001

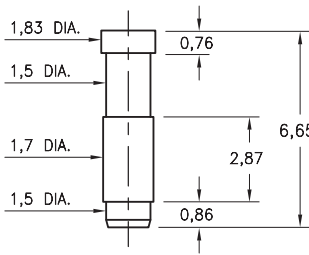

2820

2820-0-00-XX-00-00-03-0

Also available in HSMT connector series:
328-XX-1XX-40-020001
1,450 parts per 330mm reel
See page 87.4 for Tape & Reel details

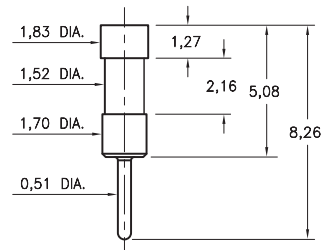

SPECIFICATIONS:

Pin Material: Brass Alloy 360, 1/2 Hard
(Except where noted)

Dimensions: Inches

Tolerances On: Lengths: ±.005
Diameters: ±.002
Angles: ± 2°



ORDER CODE: XXXX - X - 0X - XX - 00 - 00 - XX - 0

BASIC PART #

SPECIFY PIN FINISH:

- 01 200 μ" TIN/LEAD OVER NICKEL
- ◆ 80 200 μ" TIN OVER NICKEL (RoHS)
- ◆ 15 10 μ" GOLD OVER NICKEL (RoHS)
- ◆ 21 20 μ" GOLD OVER NICKEL (RoHS)
- ◆ 34 50 μ" GOLD OVER NICKEL (RoHS)

MALE PCB PINS

PRINTED CIRCUIT PINS

8685/9036

XXXX-0-00-XX-00-00-03-0

Press-fit in 0,84 mounting hole
Pin material is Phosphor Bronze 544 (B2)

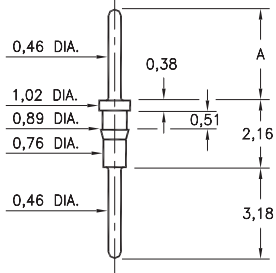

Basic Part Number	Length A
8685-0	3,18
9036-0	4,45

3790

3790-0-00-XX-00-00-03-0

Press-fit in 1,45 mounting hole

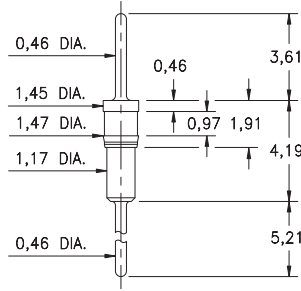

3796

3796-0-00-XX-00-00-03-0

Press-fit in 1,45 mounting hole

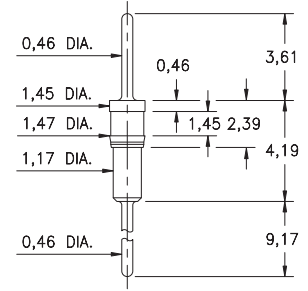

9051

9051-0-00-XX-00-00-03-0

Press-fit in 1,45 mounting hole

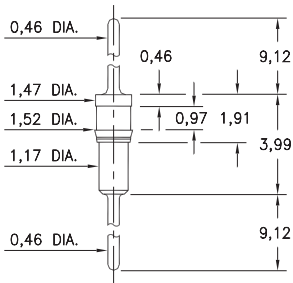

6109

6109-0-00-XX-00-00-03-0

Press-fit in 0,66 mounting hole

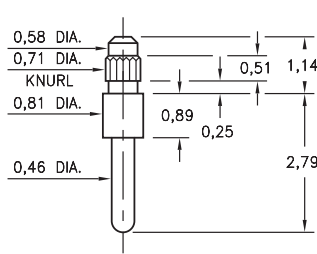

9159

9159-0-00-XX-00-00-03-0

Press-fit in 0,66 mounting hole

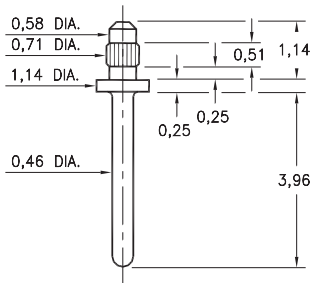

4366

4366-0-00-XX-00-00-03-0

Hex press-fit in 0,86 plated through-hole

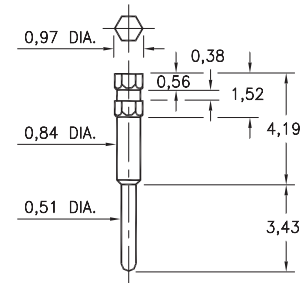

7979/8979

X979-0-00-XX-00-00-03-0

Hex press-fit in 1,88 plated through-hole

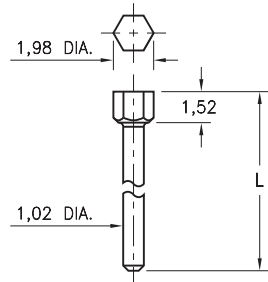

Basic Part Number	Length L
8979-0	9,68
7979-0	17,6

4397

4397-0-00-XX-00-00-03-0

Press-fit in 1,24 mounting hole

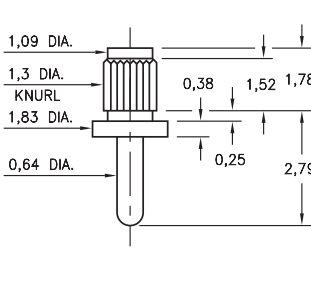

5344

5344-0-00-XX-00-00-03-0

Press-fit in 2,08 mounting hole

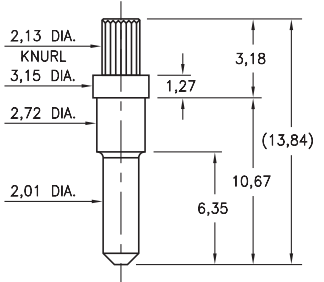

SPECIFICATIONS:

Pin Material: Brass Alloy 360, 1/2 Hard
(Except where noted)

Dimensions: Millimeters

Tolerances On: Lengths: $\pm 0,13$
Diameters: $\pm 0,051$
Angles: $\pm 2^\circ$



ORDER CODE: XXXX - X - 0X - XX - 00 - 00 - XX - 0

BASIC PART #

SPECIFY PIN FINISH:

- 01 5,08 μ m TIN/LEAD OVER NICKEL
- ◆ 80 5,08 μ m TIN OVER NICKEL (RoHS)
- ◆ 15 0,25 μ m GOLD OVER NICKEL (RoHS)
- ◆ 21 0,51 μ m GOLD OVER NICKEL (RoHS)
- ◆ 34 1,27 μ m GOLD OVER NICKEL (RoHS)



MALE PCB PINS

PRINTED CIRCUIT PINS

X435

X435-X-05-XX-00-00-03-0

Square press-fit in 0,56 plated through-hole

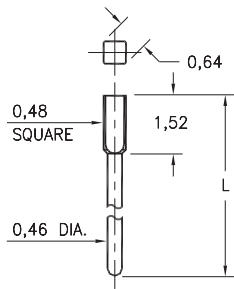

Basic Part Number	Length L
5435-0	7,70
5435-1	5,08
5435-2	10,49
6435-0	7,11

8969

8969-0-05-XX-00-00-03-0

Square press-fit in 0,58 plated through-hole (Use .7mm drill prior to plating)

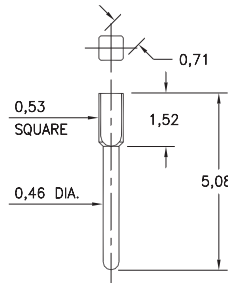

5835

5835-0-05-XX-00-00-03-0

Square press-fit in 0,81 plated through-hole

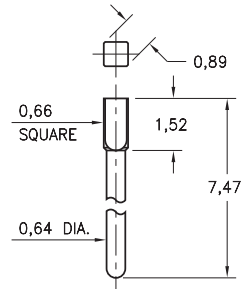

1267

1267-0-00-XX-00-00-03-0

Press-fit in 0,89 mounting hole

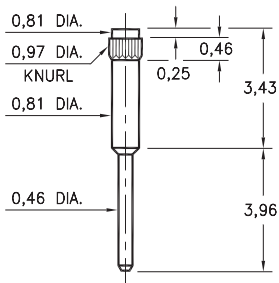

7827

7827-0-00-XX-00-00-03-0

Press-fit in 0,89 mounting hole

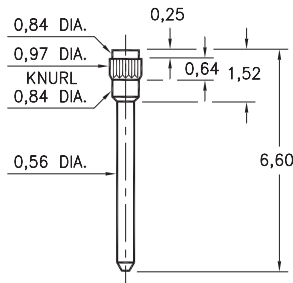

5145

5145-0-00-XX-00-00-03-0

Press-fit in 0,66 mounting hole

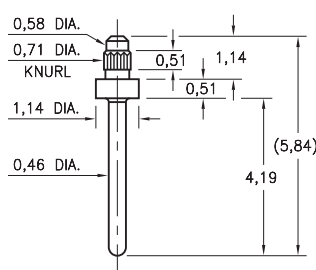

8797

8797-0-00-XX-00-00-03-0

Press-fit in 0,66 mounting hole

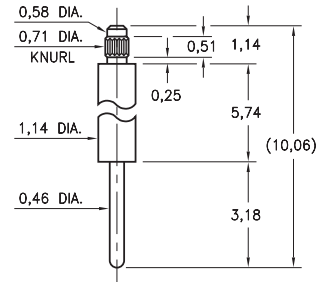

3155/5155

X155-0-00-XX-00-00-03-0

Press-fit in 0,66 mounting hole
Pin material is Phosphor Bronze 544 (B2)

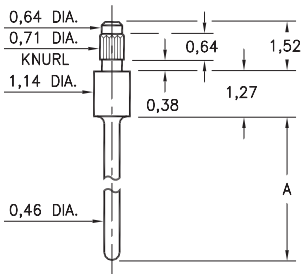

Basic Part Number	Length A
3155-0	4,57
5155-0	3,30

6061

6061-0-00-XX-00-00-03-0

Press-fit in 1,02 mounting hole

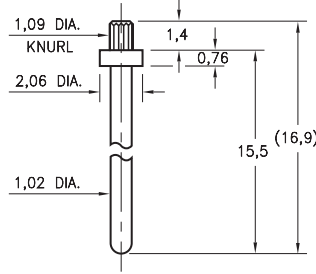

4526

4526-0-00-XX-00-00-03-0

Press-fit in 1,02 mounting hole

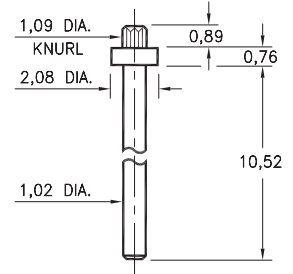

SPECIFICATIONS:

Pin Material: Brass Alloy 360, 1/2 Hard
(Except where noted)

Dimensions: Millimeters

Tolerances On: Lengths: $\pm 0,13$
Diameters: $\pm 0,051$
Angles: $\pm 2^\circ$



ORDER CODE: XXXX - X - 0X - XX - 00 - 00 - XX - 0

BASIC PART #

SPECIFY PIN FINISH:

- 01** 5,08 μ m TIN/LEAD OVER NICKEL
- 80** 5,08 μ m TIN OVER NICKEL (RoHS)
- 15** 0,25 μ m GOLD OVER NICKEL (RoHS)
- 21** 0,51 μ m GOLD OVER NICKEL (RoHS)
- 34** 1,27 μ m GOLD OVER NICKEL (RoHS)



MALE PCB PINS

PRINTED CIRCUIT PINS

1067

1067-X-00-XX-00-00-03-0

Press-fit in 1,07/1,40 mounting hole

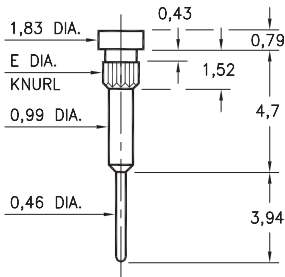

Basic Part Number	Knurl Dia. E	Mounting Hole
1067-1	1,47	1,40
1067-2	1,14	1,07

3158

3158-0-00-XX-00-00-03-0

Press-fit in 0,58 mounting hole

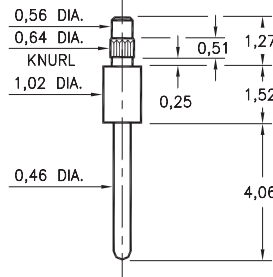

9000

9000-0-00-XX-00-00-03-0

Pentagonal press-fit in 0,64 plated through-hole

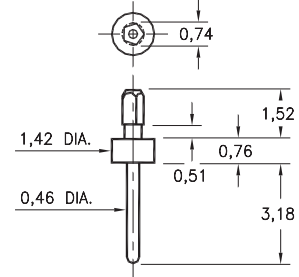

3157

3157-0-00-XX-00-00-03-0

Press-fit in 0,66 mounting hole

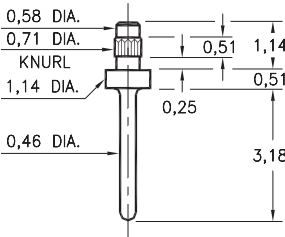

0915

0915-0-00-XX-00-00-03-0

Press-fit in 1,45 mounting hole

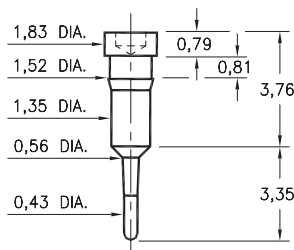

3154

3154-0-00-XX-00-00-03-0

Press-fit in 0,66 mounting hole
Pin material is Phosphor Bronze 544 (B2)

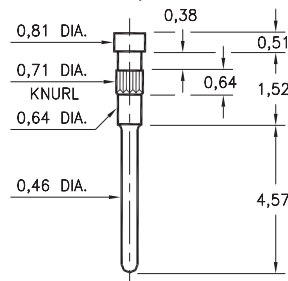

0542

0542-0-00-XX-00-00-03-0

Hex press-fit in 0,99 plated through-hole

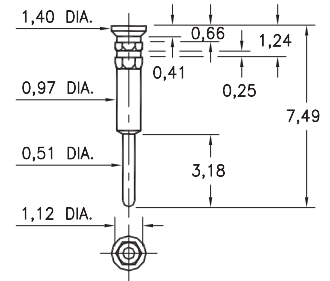

0522

0522-0-00-XX-00-00-03-0

Pentagonal press-fit in 1,07 plated through-hole

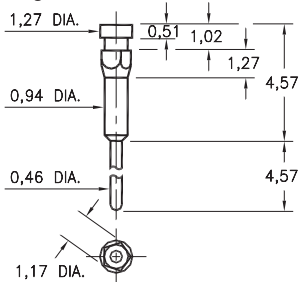

0952

0952-0-00-XX-00-00-03-0

Press-fit in 1,42 mounting hole

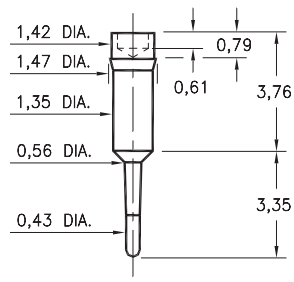

0257

0257-0-00-XX-00-00-03-0

Press-fit in 1,50 mounting hole

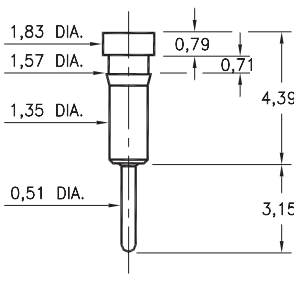

8940

8940-0-00-XX-00-00-03-0

Press-fit in 1,45 mounting hole

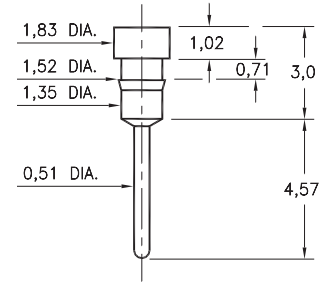

SPECIFICATIONS:

Pin Material: Brass Alloy 360, 1/2 Hard
(Except where noted)

Dimensions: Millimeters

Tolerances On: Lengths: $\pm 0,13$
Diameters: $\pm 0,051$
Angles: $\pm 2^\circ$



ORDER CODE: **XXXX - X - 00 - XX - 00 - 00 - 03 - 0**

BASIC PART #

SPECIFY PIN FINISH:

- 01 5,08 μ m TIN/LEAD OVER NICKEL
- ◆ 80 5,08 μ m TIN OVER NICKEL (RoHS)
- ◆ 15 0,25 μ m GOLD OVER NICKEL (RoHS)
- ◆ 21 0,51 μ m GOLD OVER NICKEL (RoHS)
- ◆ 34 1,27 μ m GOLD OVER NICKEL (RoHS)



MALE PCB PINS

PRINTED CIRCUIT PINS

0504/0505

050X-0-00-XX-00-00-03-0

Press-fit in 1,45 mounting hole

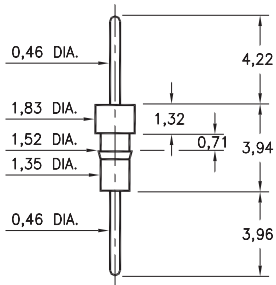

Basic Part Number	Pin Material
0504-0	Phosphor Bronze 544
0505-0	Brass 360

5510/5511

551X-0-00-XX-00-00-03-0

Press-fit in 1,45 mounting hole

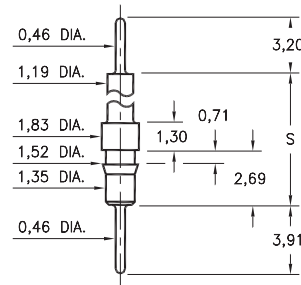

Basic Part Number	Standoff Height S
5510-0	8,41
5511-0	15,39

4259

4259-X-00-XX-00-00-03-0

Press-fit in 1,45 mounting hole

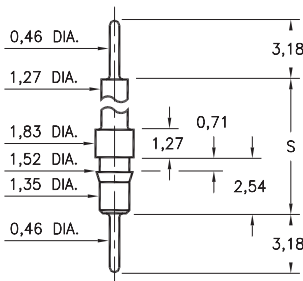

Basic Part Number	Standoff Height S
4259-1	5,33
4259-2	8,51
4259-3	14,86
4259-4	21,21

X516

X516-0-00-XX-00-00-03-0

Press-fit in 1,45 mounting hole

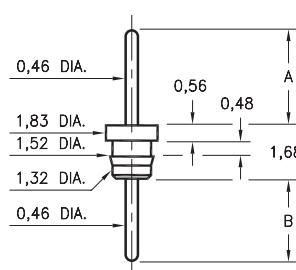

Basic Part Number	Pin Length A	Pin Length B
3516-0	3,18	2,74
4516-0	3,43	3,0

8859

8859-0-00-XX-00-00-03-0

Press-fit in 1,42 mounting hole

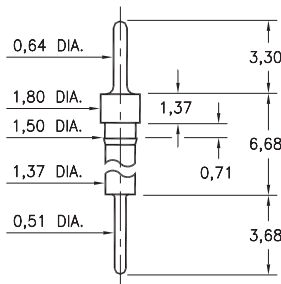

6585

6585-0-00-XX-00-00-03-0

Press-fit in 1,45 mounting hole
Pin material is Phosphor Bronze 544 (B2)

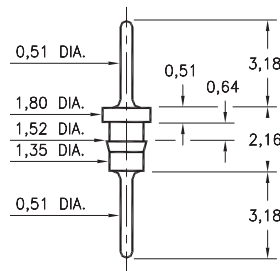

3404

3404-0-00-XX-00-00-03-0

Press-fit in 1,45 mounting hole

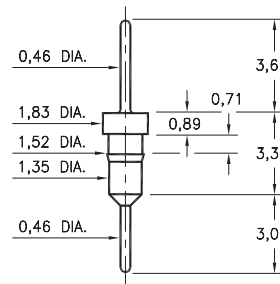

9218

9218-0-00-XX-00-00-03-0

Press-fit in 1,45 mounting hole

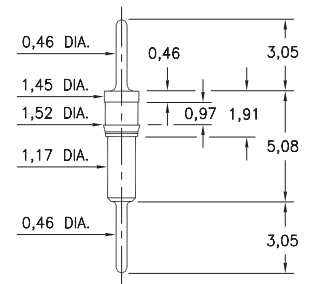

SPECIFICATIONS:

Pin Material: Brass Alloy 360, 1/2 Hard
(Except where noted)

Dimensions: Millimeters

Tolerances On: Lengths: $\pm 0,13$
Diameters: $\pm 0,051$
Angles: $\pm 2^\circ$



ORDER CODE: **XXXX - X - 00 - XX - 00 - 00 - 03 - 0**

BASIC PART #

SPECIFY PIN FINISH:

- 01 5,08 μ m TIN/LEAD OVER NICKEL
- ◆ 80 5,08 μ m TIN OVER NICKEL (RoHS)
- ◆ 15 0,25 μ m GOLD OVER NICKEL (RoHS)
- ◆ 21 0,51 μ m GOLD OVER NICKEL (RoHS)
- ◆ 34 1,27 μ m GOLD OVER NICKEL (RoHS)



MALE PCB PINS

PRINTED CIRCUIT PINS

1752/6458

XXXX-0-00-XX-00-00-03-0

Press-fit in 1,45 mounting hole

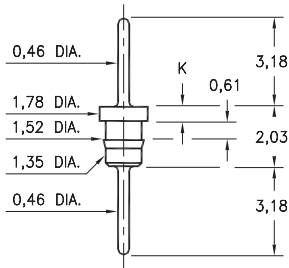

Basic Part Number	Length K
1752-0	0,51
6458-0	0,89

3413/8404

X4XX-0-00-XX-00-00-03-0

Press-fit in 1,45 mounting hole

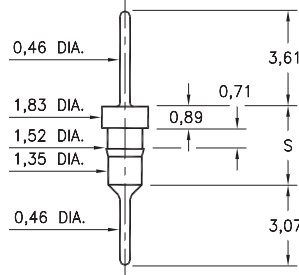

Basic Part Number	Length S
3413-0	3,0
8404-0	3,33

9075

9075-0-00-XX-00-00-03-0

Press-fit in 0,86 mounting hole

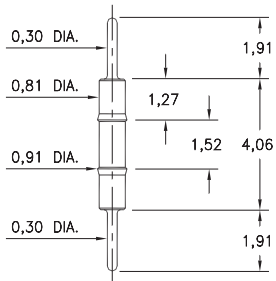

2617

2617-0-01-XX-00-00-03-0

Compliant press-fit in 1,02 ± 0,08 plated hole. For 1,52 → 2,54 thick board

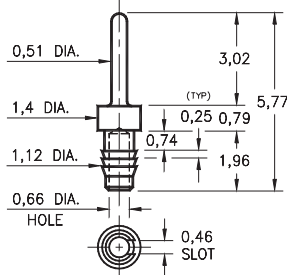

5607

5607-0-01-XX-00-00-03-0

Compliant press-fit in 1,02 ± 0,08 plated hole. For 1,52 → 2,54 thick board

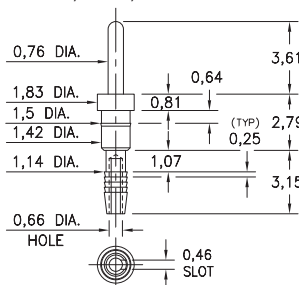

8995

8995-0-01-XX-00-00-03-0

Compliant press-fit in 1,02 ± 0,08 plated hole. For 1,52 → 2,54 thick board

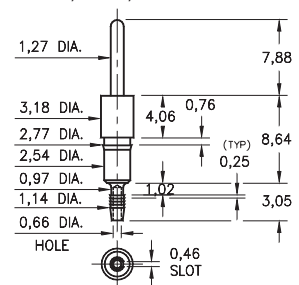

9218

9218-0-00-XX-00-00-03-0

Press-fit in 1,45 mounting hole

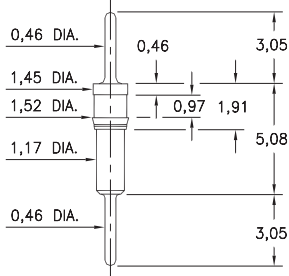

5065

5065-0-00-26-00-00-03-0

Press-fit in 0,94 mounting hole

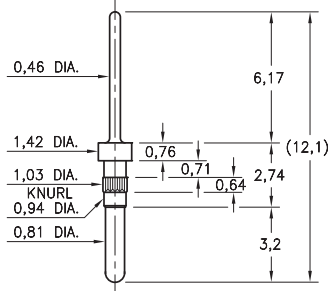

SPECIFICATIONS:

Pin Material: Brass Alloy 360, 1/2 Hard
(Except where noted)

Dimensions: Millimeters

Tolerances On: Lengths: ± 0,13
Diameters: ± 0,051
Angles: ± 2°



ORDER CODE: XXXX - X - 0X - XX - 00 - 00 - 03 - 0

BASIC PART #

SPECIFY PIN FINISH:

- 01 5,08µm TIN/LEAD OVER NICKEL
- ◆ 80 5,08µm TIN OVER NICKEL (RoHS)
- ◆ 15 0,25µm GOLD OVER NICKEL (RoHS)
- ◆ 21 0,51µm GOLD OVER NICKEL (RoHS)
- ◆ 34 1,27µm GOLD OVER NICKEL (RoHS)



MALE PCB PINS

PRINTED CIRCUIT PINS

3409

3409-X-00-XX-00-00-03-0

Press-fit in 1,45 mounting hole

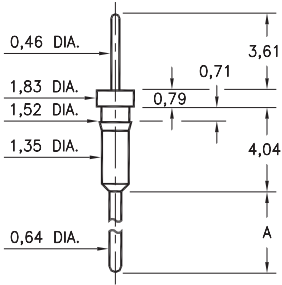

Basic Part Number	Pin Length A
3409-1	5,33
3409-2	10,67

0315

0315-0-00-XX-00-00-03-0

Press-fit in 1,45 mounting hole
Pin material is Phosphor Bronze 544 (B2)

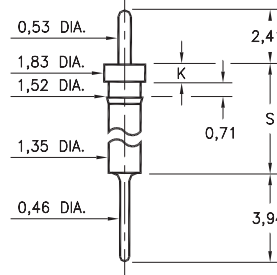

Basic Part Number	Head Height K	Standoff Height S
0315-0	0,76	4,83
0315-1	1,02	10,92

5503/5509

550X-X-00-XX-00-00-03-0

Press-fit in 1,45 mounting hole

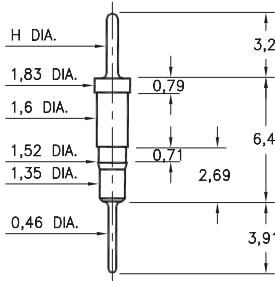

Basic Part Number	Pin Diameter H
5503-0	0,64
5509-0	0,46

5504/5505

550X-0-00-XX-00-00-03-0

Press-fit in 1,45 mounting hole

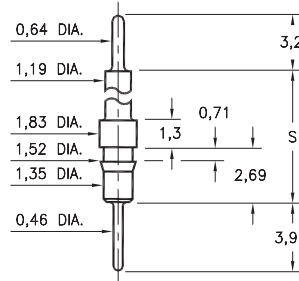

Basic Part Number	Standoff Height S
5504-0	8,41
5505-0	15,39

3406

3406-0-00-XX-00-00-03-0

Press-fit in 1,45 mounting hole

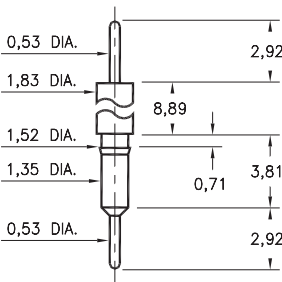

5011

5011-0-00-XX-00-00-03-0

Press-fit in 1,45 mounting hole

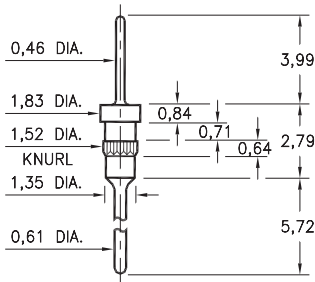

5113

5113-0-00-XX-00-00-03-0

Press-fit in 1,45 mounting hole

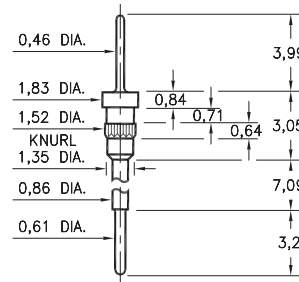

3900

3900-0-00-15-00-00-03-0

Press-fit in 1,45 mounting hole

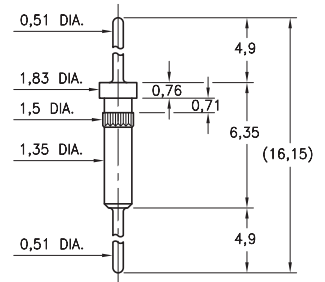

SPECIFICATIONS:

Pin Material: Brass Alloy 360, 1/2 Hard
(Except where noted)

Dimensions: Millimeters

Tolerances On: Lengths: $\pm 0,13$
Diameters: $\pm 0,051$
Angles: $\pm 2^\circ$



ORDER CODE: XXXX - X - 00 - XX - 00 - 00 - 03 - 0

BASIC PART #

SPECIFY PIN FINISH:

- 01 5,08 μ m TIN/LEAD OVER NICKEL
- ◆ 80 5,08 μ m TIN OVER NICKEL (RoHS)
- ◆ 15 0,25 μ m GOLD OVER NICKEL (RoHS)
- ◆ 21 0,51 μ m GOLD OVER NICKEL (RoHS)
- ◆ 34 1,27 μ m GOLD OVER NICKEL (RoHS)



MALE PCB PINS

PRINTED CIRCUIT PINS

3400 ⇨ 3402/3405/3410

34XX-0-00-XX-00-00-03-0

Press-fit in 1,45 mounting hole

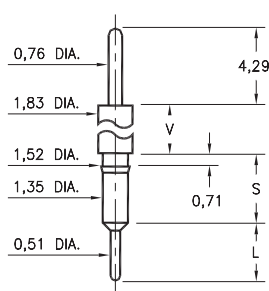

Basic Part Number	Shoulder Height V	Length S	Length L
3402-0	1,32	3,51	2,92
3401-0	2,54	3,45	2,92
3405-0	4,29	3,71	2,92
3400-0	11,71	3,68	2,92
3410-0	23,72	3,45	3,15

3411

3411-X-00-XX-00-00-03-0

Press-fit in 1,45 mounting hole

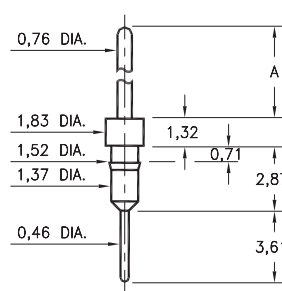

Basic Part Number	Pin Length A
3411-0	10,59
3411-1	5,51

0600

0600-0-05-XX-00-00-01-0

Solder mount 1,32 mounting hole

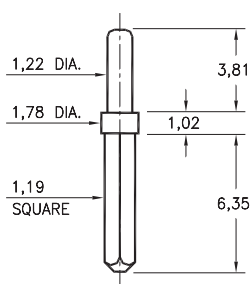

0290

0290-0-00-XX-00-00-03-0

Press-fit in 1,45 mounting hole

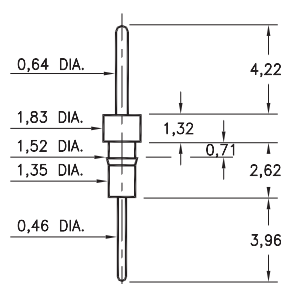

7007

7007-0-00-XX-00-00-03-0

Press-fit in 1,45 mounting hole

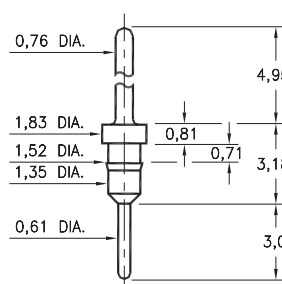

5016

5016-0-00-XX-00-00-03-0

Press-fit in 1,45 mounting hole

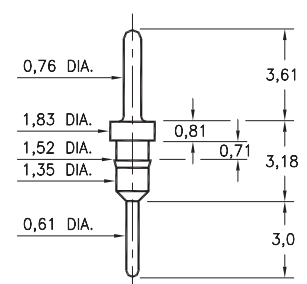

5005

5005-0-00-XX-00-00-03-0

Press-fit in 1,45 mounting hole

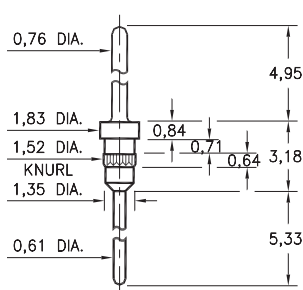

5107

5107-0-00-XX-00-00-03-0

Press-fit in 1,45 mounting hole

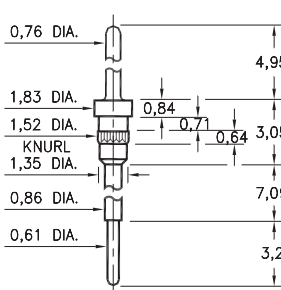

8919

8919-0-00-XX-00-00-03-0

Press-fit in 1,45 mounting hole

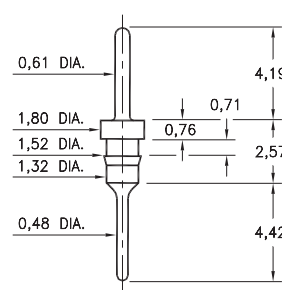

3077

3077-0-00-XX-00-00-03-0

Press-fit in 1,45 mounting hole

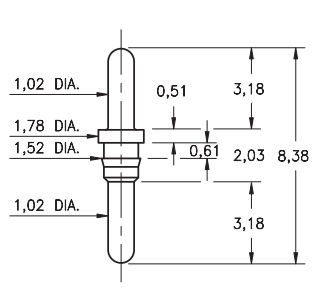

SPECIFICATIONS:

Pin Material: Brass Alloy 360, 1/2 Hard
(Except where noted)

Dimensions: Millimeters

Tolerances On: Lengths: ± 0,13
Diameters: ± 0,051
Angles: ± 2°



ORDER CODE: XXXX - X - 0X - XX - 00 - 00 - XX - 0

BASIC PART #

SPECIFY PIN FINISH:

- 01 5,08µm TIN/LEAD OVER NICKEL
- ◆ 80 5,08µm TIN OVER NICKEL (RoHS)
- ◆ 15 0,25µm GOLD OVER NICKEL (RoHS)
- ◆ 21 0,51µm GOLD OVER NICKEL (RoHS)
- ◆ 34 1,27µm GOLD OVER NICKEL (RoHS)



MALE PCB PINS

PRINTED CIRCUIT PINS

3408

3408-X-00-XX-00-00-03-0

Press-fit in 1,45 mounting hole

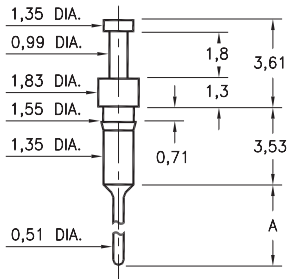

Basic Part Number	Pin Length A
3408-1	3,07
3408-2	4,60

0270/0282

02XX-0-01-XX-00-00-03-0

Press-fit in 1,45 mounting hole

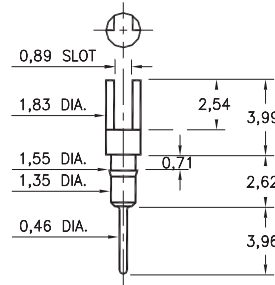

Basic Part Number	Pin Material
0270-0	Phosphor Bronze 544
0282-0	Brass 360

0700

0700-0-00-XX-00-00-03-0

Press-fit in 1,45 mounting hole

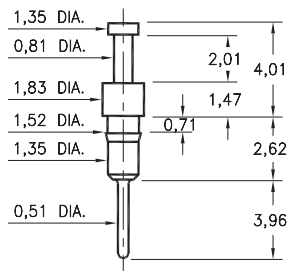

8006

8006-0-00-XX-00-00-03-0

Press-fit in 0,86 mounting hole

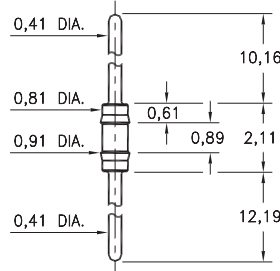

0265

0265-0-01-XX-00-00-03-0

Press-fit in 1,45 mounting hole

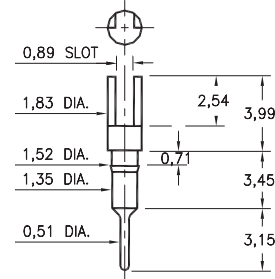

0272

0272-0-01-XX-00-00-03-0

Press-fit in 1,45 mounting hole

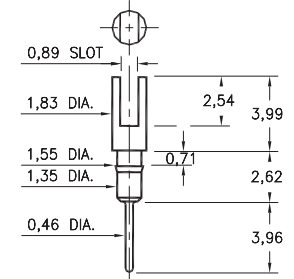

8000

8000-0-01-XX-00-00-03-0

Press-fit in 1,45 mounting hole

For wire sizes up to 22 AWG

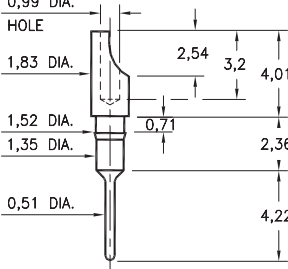

0275

0275-0-01-XX-00-00-03-0

Press-fit in 1,45 mounting hole

Pin material is Phosphor Bronze 544 (B2)

For wire sizes up to 22 AWG

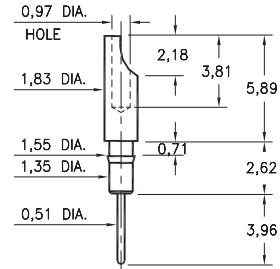

1107

1107-0-01-15-00-00-03-0

Press-fit in 1,45 mounting hole

For wire sizes up to 20 AWG

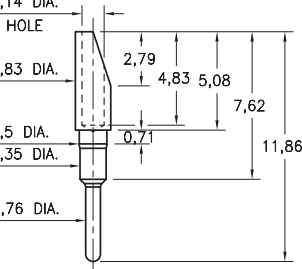

9976

9976-0-00-XX-00-00-03-0

Press-fit in 0,97 mounting hole

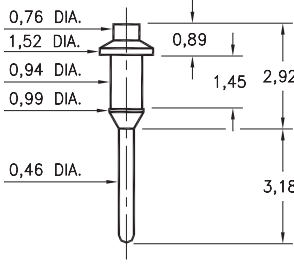

SPECIFICATIONS:

Pin Material: Brass Alloy 360, 1/2 Hard
(Except where noted)

Dimensions: Millimeters

Tolerances On: Lengths: $\pm 0,13$
Diameters: $\pm 0,051$
Angles: $\pm 2^\circ$



ORDER CODE: XXXX - X - 0X - XX - 00 - 00 - XX - 0

BASIC PART #

SPECIFY PIN FINISH:

- 01 5,08 μ m TIN/LEAD OVER NICKEL
- ◆ 80 5,08 μ m TIN OVER NICKEL (RoHS)
- ◆ 15 0,25 μ m GOLD OVER NICKEL (RoHS)
- ◆ 21 0,51 μ m GOLD OVER NICKEL (RoHS)
- ◆ 34 1,27 μ m GOLD OVER NICKEL (RoHS)



MALE PCB PINS

PRINTED CIRCUIT PINS

3117

3117-X-00-XX-00-00-08-0

Swage mount in 0,89 hole

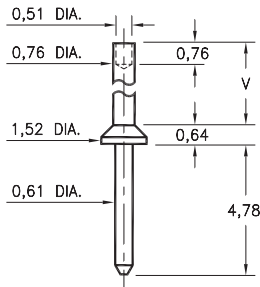

Basic Part Number	Board Thickness	Length V
3117-1	0,79	1,19
3117-2	1,57	1,98
3117-3	2,39	2,79
3117-4	3,18	3,58

3114/3115

311X-X-00-XX-00-00-08-0

Swage mount in 0,89 mounting hole

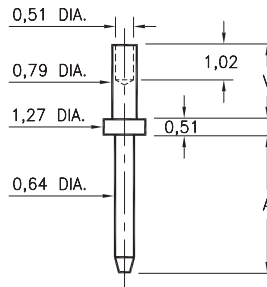

Basic Part Number	Board Thickness	Length A	Length V
3114-1	0,79	3,81	1,30
3114-2	1,57	3,81	2,08
3115-1	0,79	7,62	1,30
3115-2	1,57	7,62	2,08

3112

3112-X-00-XX-00-00-08-0

Swage mount in 1,09 hole

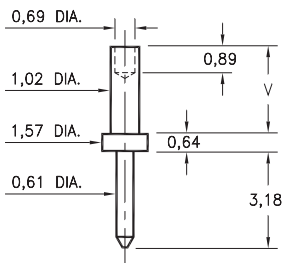

Basic Part Number	Board Thickness	Length V
3112-1	0,79	1,30
3112-2	1,57	2,08
3112-3	2,39	2,87

3118/3119

311X-X-00-XX-00-00-08-0

Swage mount in 0,89 hole

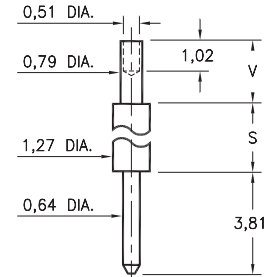

Basic Part Number	Board Thickness	Length S	Length V
3118-1	0,79	4,32	1,30
3118-2	1,57	4,32	2,08
3119-1	0,79	10,67	1,30
3119-2	1,57	10,67	2,08

3139

3139-0-00-XX-00-00-08-0

Wire crimp termination. Accepts wire sizes 24 AWG Max. / 28 AWG Min.

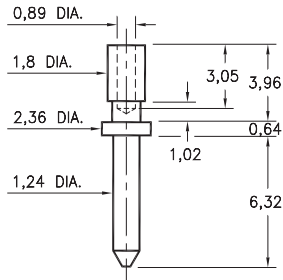

3602

3602-0-07-XX-00-00-08-0

Annealed
Wire crimp termination. Accepts wire sizes 20 AWG Max. / 24 AWG Min.

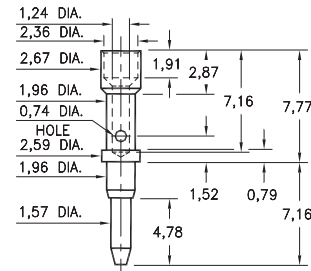

3603

3603-0-07-XX-00-00-08-0

Annealed
Wire crimp termination. Accepts wire sizes 20 AWG Max. / 24 AWG Min.

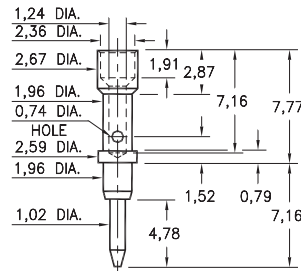

3131

3131-1-00-XX-00-00-08-0

Swage mount in 1,09 hole

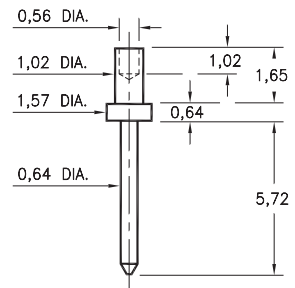

SPECIFICATIONS:

Pin Material: Brass Alloy 360, 1/2 Hard
(Except swage pins which are annealed)

Dimensions: Millimeters

Tolerances On: Lengths: $\pm 0,13$
Diameters: $\pm 0,051$
Angles: $\pm 2^\circ$



ORDER CODE: XXXX - X - 0X - XX - 00 - 00 - XX - 0

BASIC PART #

SPECIFY PIN FINISH:

- 01 5,08µm TIN/LEAD OVER NICKEL
- ◆ 80 5,08µm TIN OVER NICKEL (RoHS)
- ◆ 15 0,25µm GOLD OVER NICKEL (RoHS)
- ◆ 21 0,51µm GOLD OVER NICKEL (RoHS)
- ◆ 34 1,27µm GOLD OVER NICKEL (RoHS)



MALE PCB PINS

PRINTED CIRCUIT PINS

0259/0286/1941

XXXX-0-00-XX-00-00-03-0
Press-fit in 1,45/1,5 mounting hole
0286-0 is available on 16mm wide carrier tape; 2,500 parts per 330mm reel.
See page 224.3 for Tape & Reel details

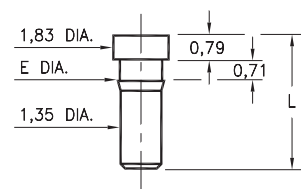

Basic Part Number	Length L	Barb Dia. E	Mounting Hole
0259-0	4,39	1,57	1,5
0286-0	2,92	1,52	1,45
* 1941-0	4,29	1,47	1,42

* Flat face Target contact

2956-0

2956-0-00-XX-00-00-03-0
Surface mount

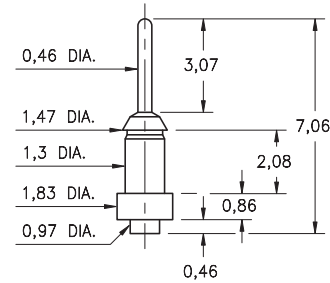

2956-1

2956-1-00-XX-00-00-03-0
Surface mount

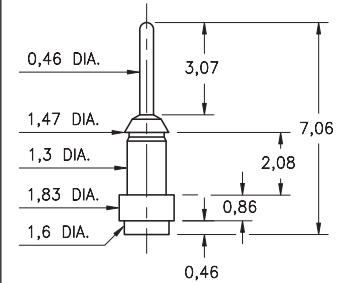

4956-1

4956-1-00-XX-00-00-33-0
Surface mount

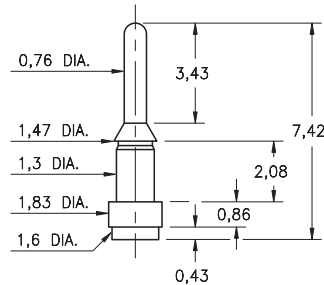

8876

8876-0-00-XX-00-00-03-0
Press-fit in 1,45 mounting hole

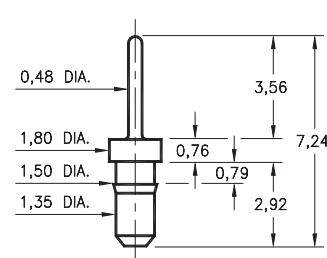

1938

1938-0-00-XX-00-00-03-0
Flat face Target contact, solder Tail

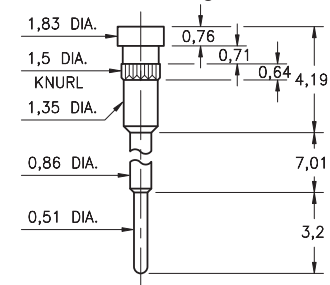

1940

1940-0-00-XX-00-00-03-0
Flat face Target contact, solder Tail

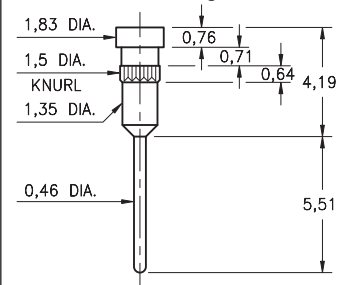

1942

1942-0-00-XX-00-00-03-0
Flat face Target contact, solder Tail

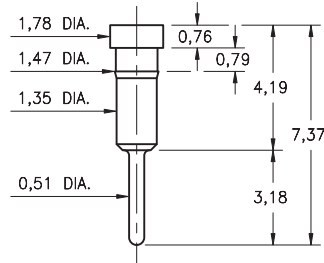

3024

3024-0-01-XX-00-00-03-0
Flat face Target contact, solder cup

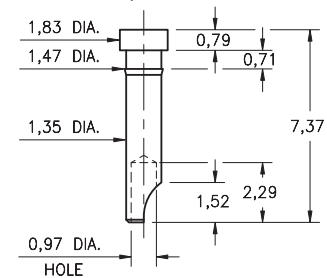

3000

3000-0-00-XX-00-00-03-0
Flat face Target contact, wire termination

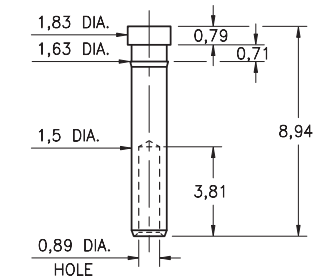

3080

3080-0-01-XX-00-00-03-0
Press-fit in 1,45 mounting hole

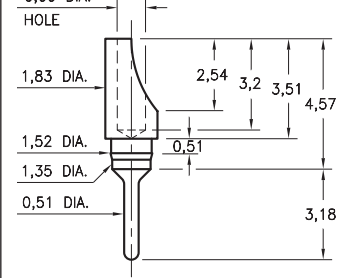

SPECIFICATIONS:

Pin Material: Brass Alloy 360, 1/2 Hard
(Except swage pins which are annealed)

Dimensions: Millimeters

Tolerances On: Lengths: $\pm 0,13$
Diameters: $\pm 0,051$
Angles: $\pm 2^\circ$



ORDER CODE: XXXX - X - 0X - XX - 00 - 00 - XX - 0

BASIC PART #

SPECIFY PIN FINISH:

- 01 5,08 μ m TIN/LEAD OVER NICKEL
- ◆ 80 5,08 μ m TIN OVER NICKEL (RoHS)
- ◆ 15 0,25 μ m GOLD OVER NICKEL (RoHS)
- ◆ 21 0,51 μ m GOLD OVER NICKEL (RoHS)
- ◆ 34 1,27 μ m GOLD OVER NICKEL (RoHS)



MALE PCB PINS

PRINTED CIRCUIT PINS

3130/3134

31XX-X-00-XX-00-00-08-0

Swage mount in 1,32 hole

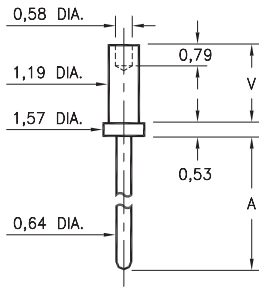

Basic Part Number	Board Thickness	Length A	Length V
3134-1	0,79	2,01	1,30
3134-2	1,57	2,01	2,08
3134-3	2,39	2,01	2,87
3134-4	3,18	2,01	3,68
3130-1	0,79	4,55	1,30
3130-2	1,57	4,55	2,08
3130-3	2,39	4,55	2,87
3130-4	3,18	4,55	3,68

3113

3113-X-00-XX-00-00-08-0

Swage mount in 1,57 hole

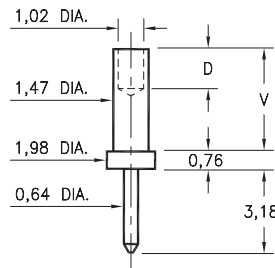

Basic Part Number	Board Thickness	Length V	Depth D
3113-1	0,79	1,57	1,02
3113-2	1,57	2,39	1,57
3113-3	2,39	3,18	1,57
3113-4	3,18	3,96	1,57

3151

3151-X-00-XX-00-00-08-0

Swage mount in 1,32 hole

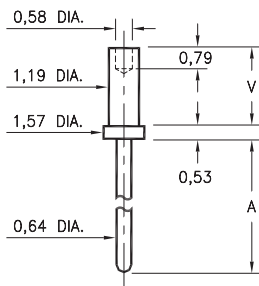

Basic Part Number	Board Thickness	Length A	Length V
3151-1	0,79	12,17	1,30
3151-2	1,57	12,17	2,08
3151-3	2,39	12,17	2,87
3151-4	3,18	12,17	3,68

3301 → 3304

330X-X-14-XX-00-00-08-0

Specify board thickness

Swage mount in 1,09 hole

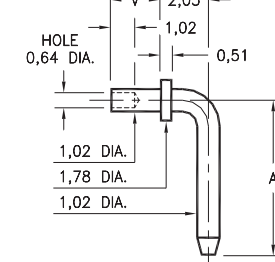

Basic Part Number	Pin Centers A
3301-X	6,53
3302-X	9,07
3303-X	9,53
3304-X	14,27

- X -	Board Thickness	Length V
1	0,79	1,30
2	1,57	2,08
3	2,39	2,87

3620

3620-X-32-XX-00-00-08-0

Board edge rivet mount.

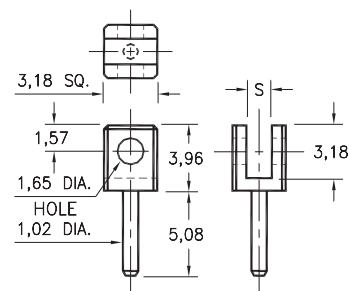

Basic Part Number	Board Thickness	Slot S
3620-1	0,79	1,19
3620-2	1,57	1,91

0940

0940-0-00-XX-00-00-03-0

Press-fit in 1,45 mounting hole

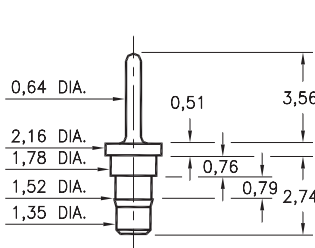

3621

3621-0-32-XX-00-00-08-0

Board edge rivet mount

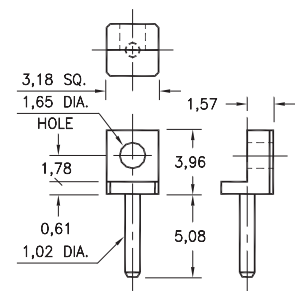

SPECIFICATIONS:

Pin Material: Brass Alloy 360, 1/2 Hard
(Except swage pins which are annealed)

Dimensions: Millimeters

Tolerances On: Lengths: ± 0,13
Diameters: ± 0,051
Angles: ± 2°



ORDER CODE: XXXX - X - 0X - XX - 00 - 00 - XX - 0

BASIC PART #

SPECIFY PIN FINISH:

- 01 5,08µm TIN/LEAD OVER NICKEL
- ◆ 80 5,08µm TIN OVER NICKEL (RoHS)
- ◆ 15 0,25µm GOLD OVER NICKEL (RoHS)
- ◆ 21 0,51µm GOLD OVER NICKEL (RoHS)
- ◆ 34 1,27µm GOLD OVER NICKEL (RoHS)



MALE PCB PINS

PRINTED CIRCUIT PINS

3110/3111

311X-X-00-XX-00-00-08-0

Swage mount in 1,09 hole

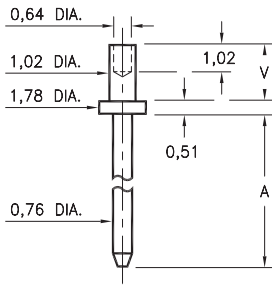

Basic Part Number	Board Thickness	Length A	Length V
3110-1	0,79	3,81	1,30
3110-2	1,57	3,81	2,08
3110-3	2,39	3,81	2,87
3111-1	0,79	7,62	1,30
3111-2	1,57	7,62	2,08
3111-3	2,39	7,62	2,87

3150

3150-X-00-XX-00-00-08-0

Swage mount in 1,09 mounting hole

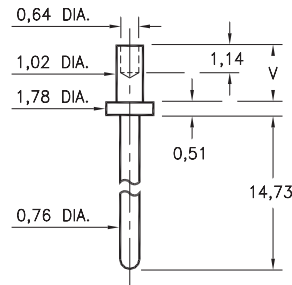

Basic Part Number	Board Thickness	Length V
3150-1	0,79	1,30
3150-2	1,57	2,08

3136/3137

313X-X-00-XX-00-00-08-0

Solder mount in 1,09 mounting hole
3137-1 is available on 16mm wide carrier tape: 580 parts per 330mm reel.
See page 224.2 for Tape & Reel details

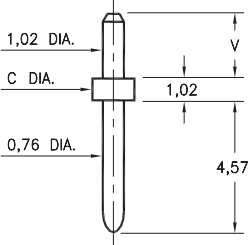

Basic Part Number	Board Thickness	Length V	Flange Dia. C
3136-1	1,57	2,08	
3136-2	2,39	2,79	1,98
3136-3	3,18	3,68	
3137-1	1,57	2,08	1,57
3137-2	2,39	2,79	
3137-3	3,18	3,68	
3137-4	3,96	4,70	

3148

3148-3-00-XX-00-00-08-0

Swage mount in 1,57 hole
For a 2,39 thick board

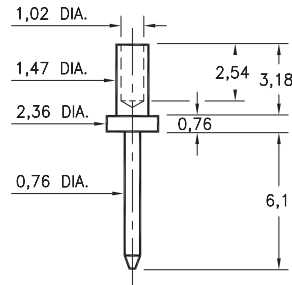

8815

8815-0-00-XX-00-00-03-0

Hex press-fit in 1,68 plated through-hole

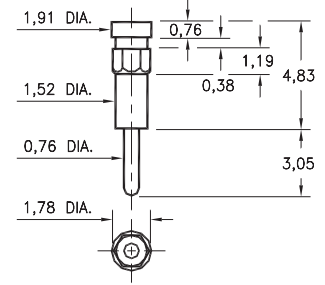

6821

6821-0-00-XX-00-00-08-0

Turret terminal pin

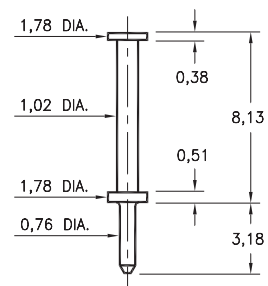

3132

3132-0-00-XX-00-00-08-0

Wire crimp termination, Annealed
Accepts wire sizes 22 AWG Max. / 24 AWG Min.

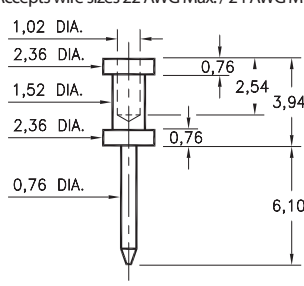

5601

5601-0-01-XX-00-00-03-0

Compliant press-fit in 1,02 ± 0,08 plated through-hole. For 1,52 → 2,54 thick board

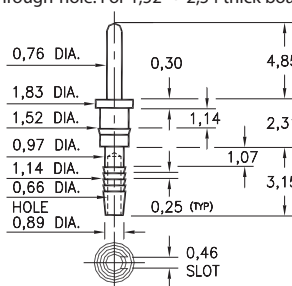

5602

5602-0-01-XX-00-00-03-0

Compliant press-fit in 1,02 ± 0,08 plated through-hole. For 2,29 → 3,30 thick board

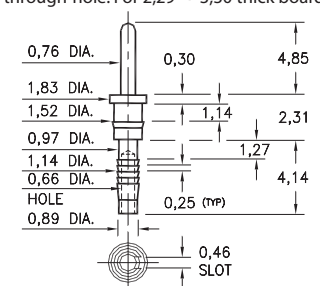

SPECIFICATIONS:

Pin Material: Brass Alloy 360, 1/2 Hard
(Except swage pins which are annealed)

Dimensions: Millimeters

Tolerances On: Lengths: ± 0,13
Diameters: ± 0,051
Angles: ± 2°



ORDER CODE: XXXX - X - 0X - XX - 00 - 00 - XX - 0

BASIC PART #

SPECIFY PIN FINISH:

- 01 5,08µm TIN/LEAD OVER NICKEL
- ◆ 80 5,08µm TIN OVER NICKEL (RoHS)
- ◆ 15 0,25µm GOLD OVER NICKEL (RoHS)
- ◆ 21 0,51µm GOLD OVER NICKEL (RoHS)
- ◆ 34 1,27µm GOLD OVER NICKEL (RoHS)



MALE PCB PINS

PRINTED CIRCUIT PINS

3120

3120-X-00-XX-00-00-08-0

Swage mount in 0,86 hole

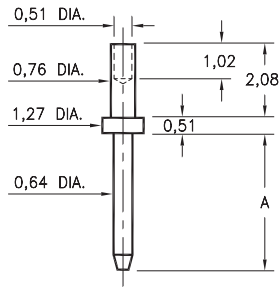

Basic Part Number	Pin Length A
3120-1	5,21
3120-2	6,35

3122 ⇔ 3153

31XX-X-00-XX-00-00-08-0

Swage mount in 1,09 hole

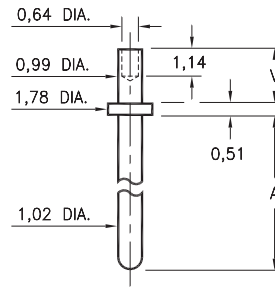

Basic Part Number	Pin Length A
3153-X	4,57
3141-X	5,84
3122-X	7,11
3149-X	9,65
3123-X	14,73
3140-X	19,81
3124-X	22,35

-X-	Board Thickness	Length V
1	0,79	1,3
2	1,57	2,08

3101 ⇔ 3106

310X-X-00-XX-00-00-08-0

Swage mount in 1,09 hole

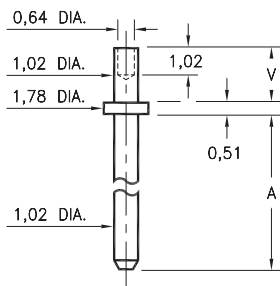

Basic Part Number	Pin Length A
3101-X	3,81
3102-X	4,78
3103-X	7,62
3104-X	12,7
3105-X	19,05
3106-X	25,40

-X-	Board Thickness	Length V
1	0,79	1,30
2	1,57	2,08
3	2,39	2,87

3221 ⇔ 3223

322X-0-00-XX-00-00-08-0

Swage mount in 1,09 hole

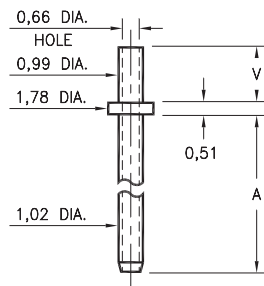

Basic Part Number	Pin Length A
3221-X	2,54
3222-X	3,81
3223-X	7,62

-X-	Board Thickness	Length V
1	0,79	1,30
2	1,57	2,08
3	2,39	2,87

3125/3126

312X-X-00-XX-00-00-08-0

Swage mount in 1,09 hole

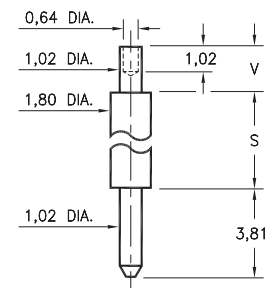

Basic Part Number	Pin Length S
3125-X	4,32
3126-X	10,67

-X-	Board Thickness	Length V
1	0,79	1,30
2	1,57	2,08
3	2,39	2,87

3116

3116-X-00-XX-00-00-08-0

Swage mount in 1,32 hole

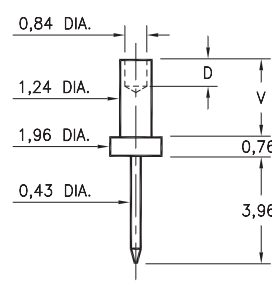

Basic Part Number	Board Thickness	Length V	Depth D
3116-1	0,79	1,30	0,89
3116-2	1,57	2,08	1,57
3116-3	2,39	2,87	1,57
3116-4	3,18	3,68	1,57

SPECIFICATIONS:

Pin Material: Brass Alloy 360, 1/2 Hard
(Except swage pins which are annealed)

Dimensions: Millimeters

Tolerances On: Lengths: ± 0,13
Diameters: ± 0,051
Angles: ± 2°



ORDER CODE: XXXX - X - 0X - XX - 00 - 00 - XX - 0

BASIC PART #

SPECIFY PIN FINISH:

- 01 5,08µm TIN/LEAD OVER NICKEL
- ◆ 80 5,08µm TIN OVER NICKEL (RoHS)
- ◆ 15 0,25µm GOLD OVER NICKEL (RoHS)
- ◆ 21 0,51µm GOLD OVER NICKEL (RoHS)
- ◆ 34 1,27µm GOLD OVER NICKEL (RoHS)



MALE PCB PINS

PRINTED CIRCUIT PINS

<p>4194 4194-0-00-XX-00-00-08-0 Wire crimp termination & press-fit in 0,91 hole Accepts wire sizes 30 AWG Max. / 36 AWG Min.</p>	<p>5556 5556-0-00-XX-00-00-38-0 Wire crimp termination. Accepts wire sizes 30 AWG Max. / 36 AWG Min.</p>	<p>3129 3129-1-00-XX-00-00-08-0 Swage mount in 0,89 hole For 0,79 thick board</p>	<p>3135 3135-1-00-XX-00-00-08-0 Swage mount in 1,02 hole For 0,79 thick board</p>
<p>3210 3210-2-00-XX-00-00-08-0 Swage mount in 0,79 hole For 1,57 thick board</p>	<p>3147 3147-3-00-XX-00-00-08-0 Swage mount in 1,09 hole For 2,39 thick board</p>	<p>4123 4123-0-00-XX-00-00-08-0 Swage mount in 1,12 hole For 1,57 thick board</p>	<p>2231 2231-0-00-XX-00-00-08-0 Swage mount in 2,36 hole For a 0,79 thick board</p>
<p>4395 4395-0-00-XX-00-00-08-0 Swage mount in 2,36 hole For a 1,57 thick board</p>	<p>5233 5233-0-00-XX-00-00-08-0 Swage mount in 2,36 hole For a 1,57 thick board</p>	<p>6788 6788-0-00-XX-00-00-03-0 Annealed Wire crimp termination. Accepts wire sizes 20 AWG Max. / 24 AWG Min.</p>	<p>6331 6331-0-00-XX-00-00-08-0 Swage mount in 2,39 hole For a 3,18 thick board</p>

SPECIFICATIONS:

Pin Material: Brass Alloy 360, 1/2 Hard
(Except swage pins which are annealed)

Dimensions: Millimeters

Tolerances On: Lengths: $\pm 0,13$
Diameters: $\pm 0,051$
Angles: $\pm 2^\circ$



ORDER CODE: **XXXX - 0 - 0X - XX - 00 - 00 - XX - 0**

BASIC PART #

SPECIFY PIN FINISH:

- 01 5,08 μ m TIN/LEAD OVER NICKEL
- ◆ 80 5,08 μ m TIN OVER NICKEL (RoHS)
- ◆ 15 0,25 μ m GOLD OVER NICKEL (RoHS)
- ◆ 21 0,51 μ m GOLD OVER NICKEL (RoHS)
- ◆ 34 1,27 μ m GOLD OVER NICKEL (RoHS)

MALE PCB PINS

PRINTED CIRCUIT PINS

8600/8954/8955

8XXX-X-05-XX-00-00-03-0

Square press-fit in 1,09 plated through-hole

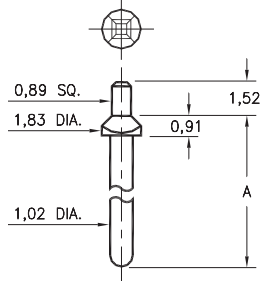

Basic Part Number	Pin Length A
8600-0	10,16
8600-1	21,59
8600-2	30,48
8954-0	3,45
8955-0	16,64

3159

3159-X-00-XX-00-00-08-0

Swage mount in 1,63 hole

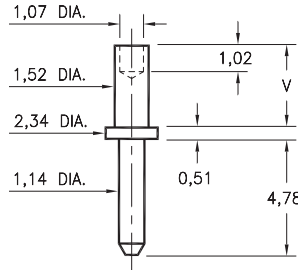

Basic Part Number	Board Thickness	Length V
3159-1	0,79	1,57
3159-2	1,57	2,39
3159-3	2,39	3,18
3159-4	3,18	3,96

8952

8952-0-05-XX-00-00-03-0

Square press-fit in 2,21 plated through-hole

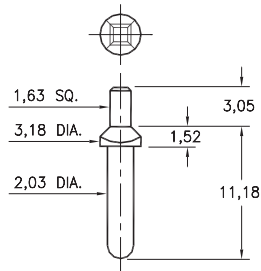

8953

8953-0-05-XX-00-00-03-0

Square press-fit in 1,19 plated through-hole

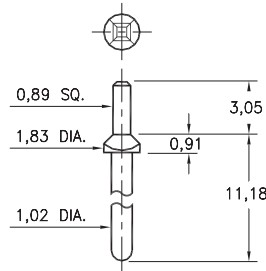

3230

3230-X-00-XX-00-00-08-0

Swage mount in 2,39 hole

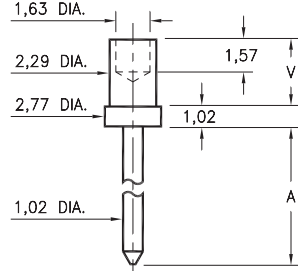

Basic Part Number	Board Thickness	Length A	Length V
3230-1	0,79	5,13	1,65
3230-2	1,57	5,79	2,41
3230-3	2,39	6,55	3,18
3230-4	3,18	7,32	3,94

3146

3146-2-00-XX-00-00-08-0

Swage mount in 1,93 hole

For a 1,57 thick board

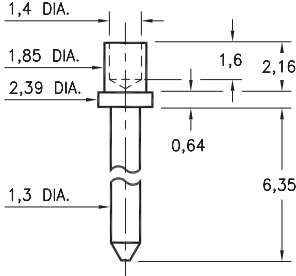

3142

3142-2-00-XX-00-00-08-0

Swage mount in 1,57 hole

For a 1,57 thick board

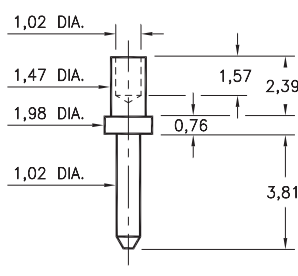

3232

3232-3-00-XX-00-00-08-0

Swage mount in 1,57 hole

For a 2,39 thick board

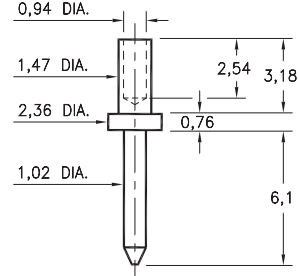

3145

3145-2-00-XX-00-00-08-0

Swage mount in 1,93 hole

For a 1,57 thick board

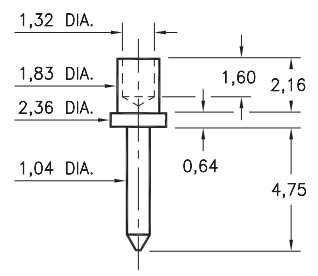

SPECIFICATIONS:

Pin Material: Brass Alloy 360, 1/2 Hard
(Except swage pins which are annealed)

Dimensions: Millimeters

Tolerances On: Lengths: $\pm 0,13$
Diameters: $\pm 0,051$
Angles: $\pm 2^\circ$



ORDER CODE: XXXX - X - 0X - XX - 00 - 00 - XX - 0

BASIC PART #

SPECIFY PIN FINISH:

- 01 5,08 μ m TIN/LEAD OVER NICKEL
- ◆ 80 5,08 μ m TIN OVER NICKEL (RoHS)
- ◆ 15 0,25 μ m GOLD OVER NICKEL (RoHS)
- ◆ 21 0,51 μ m GOLD OVER NICKEL (RoHS)
- ◆ 34 1,27 μ m GOLD OVER NICKEL (RoHS)



MALE PCB PINS

PRINTED CIRCUIT PINS

3231

3231-X-00-XX-00-00-08-0

Swage mount in 2,39 hole

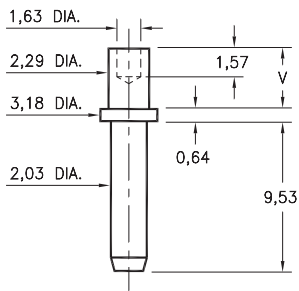

Basic Part Number	Board Thickness	Length V
3231-2	1,57	2,39
3231-3	2,39	3,18
3231-4	3,18	3,96

3609

3609-X-07-XX-00-00-08-0

Wire crimp termination. Accepts wire sizes 16 AWG Max. / 20 AWG Min.

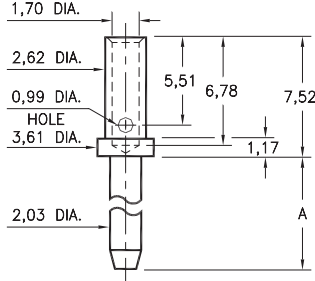

Basic Part Number	Pin Length A
3609-1	5,08
3609-2	9,53
3609-3	12,7

3601

3601-X-07-XX-00-00-08-0

Wire crimp termination. Accepts wire sizes 20 AWG Max. / 24 AWG Min.

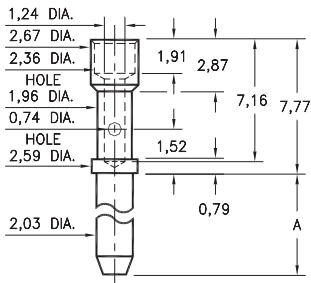

Basic Part Number	Pin Length A
3601-1	5,08
3601-2	9,53
3601-3	12,7

3133/3138/3152

31XX-X-00-XX-00-00-08-0

Specify board thickness
Swage mount in 1,63 hole

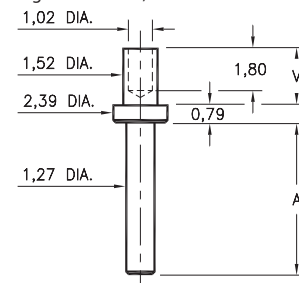

Basic Part Number	Pin Length A
3152-X	2,39
3133-X	5,56
3138-X	7,16

-X-	Board Thickness	Length V
1	0,79	1,60
2	1,57	2,39
3	2,39	3,18
4	3,18	3,96

3144

3144-X-00-XX-00-00-08-0

Swage mount in 1,70 hole

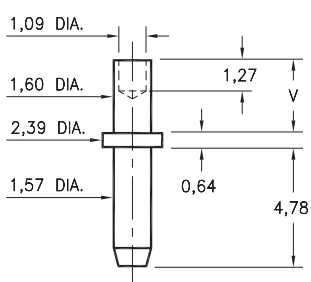

Basic Part Number	Board Thickness	Length V
3144-1	0,79	1,35
3144-2	1,57	2,13
3144-3	2,39	2,92

3233

3233-2-00-XX-00-00-08-0

Swage mount in 2,39 hole
For a 1,57 thick board

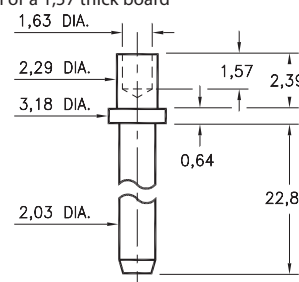

0520

0520-0-00-XX-00-00-03-0

Annealed
Wire crimp termination. Accepts wire sizes 20 AWG Max. / 24 AWG Min.

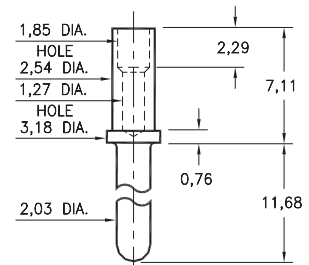

SPECIFICATIONS:

Pin Material: Brass Alloy 360, 1/2 Hard
(Except swage pins which are annealed)

Dimensions: Millimeters

Tolerances On: Lengths: $\pm 0,13$
Diameters: $\pm 0,051$
Angles: $\pm 2^\circ$



ORDER CODE: XXXX - X - 0X - XX - 00 - 00 - XX - 0

BASIC PART #

SPECIFY PIN FINISH:

- 01 5,08µm TIN/LEAD OVER NICKEL
- ◆ 80 5,08µm TIN OVER NICKEL (RoHS)
- ◆ 15 0,25µm GOLD OVER NICKEL (RoHS)
- ◆ 21 0,51µm GOLD OVER NICKEL (RoHS)
- ◆ 34 1,27µm GOLD OVER NICKEL (RoHS)



MALE PCB PINS

PRINTED CIRCUIT PINS

1943

1943-0-00-15-00-00-03-0

Concave face Target contact, surface mount
Also available on 16mm wide carrier tape:
2,200 parts per 330mm reel.
See page 224.3 for Tape & Reel details

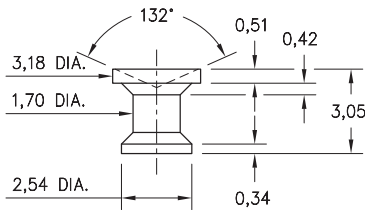

P.C.B. Layout

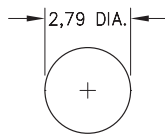

1944

1944-0-00-15-00-00-03-0

Flat face Target contact, surface mount
Also available on 16mm wide carrier tape:
2,200 parts per 330mm reel.
See page 224.3 for Tape & Reel details

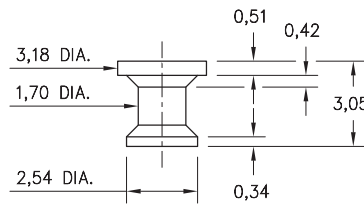

P.C.B. Layout

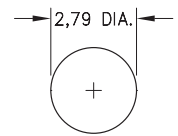

1945

1945-0-00-15-00-00-03-0

Concave face Target contact, Solder Tail

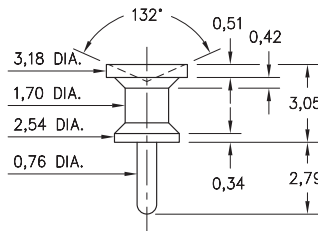

1946

1946-0-00-15-00-00-03-0

Flat face Target contact, Solder Tail

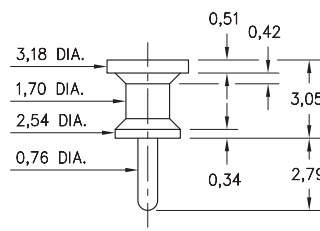

1947

1947-0-00-15-00-00-03-0

Concave face Target contact, surface mount
Press-fit in 1,42 mounting hole

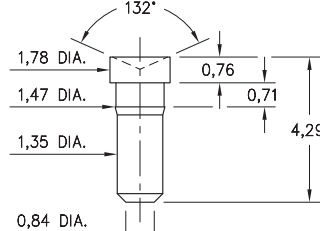

1948

1948-0-00-15-00-00-03-0

Concave face Target contact, Solder Tail
Press-fit in 1,42 mounting hole

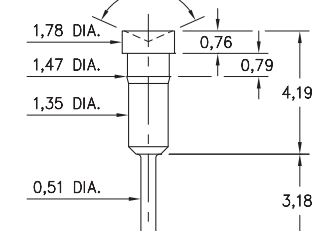

1949

1949-0-00-15-00-00-03-0

Flat face Target contact, surface mount
Press-fit in 1,42 mounting hole

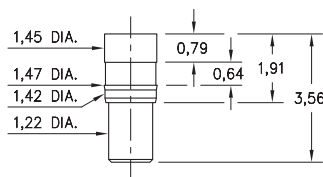

1950

1950-0-00-15-00-00-03-0

Concave face Target contact, surface mount
Press-fit in 1,42 mounting hole

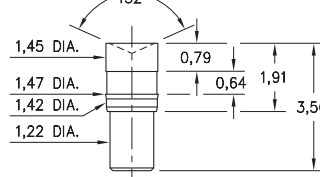

1951

1951-0-00-15-00-00-03-0

Flat face Target contact, Solder Tail
Press-fit in 1,42 mounting hole

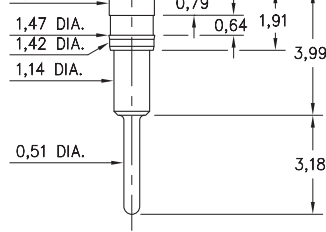

1952

1952-0-00-15-00-00-03-0

Concave face Target contact, Solder Tail
Press-fit in 1,42 mounting hole

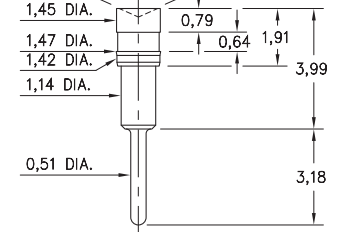

SPECIFICATIONS:

Pin Material: Brass Alloy 360, 1/2 Hard
(Except where noted)

Dimensions: Millimeters

Tolerances On: Lengths: $\pm 0,13$
Diameters: $\pm 0,051$
Angles: $\pm 2^\circ$



ORDER CODE: 194X - 0 - 00 - 15 - 00 - 00 - 03 - 0

BASIC PART #

SPECIFY PIN FINISH:

◆ 15 0,25µm GOLD OVER NICKEL (RoHS)



MALE PCB PINS

PRINTED CIRCUIT PINS

<p>1958 1958-0-00-15-00-00-03-0 Concave face Target contact, solder Tail Press-fit in 1,45 mounting hole</p>	<p>1960 1960-0-00-15-00-00-03-0 Concave face Target contact, solder Tail Press-fit in 1,45 mounting hole</p>	<p>1831 1831-1-00-15-00-00-03-0 Concave face Target contact, solder Tail Hex press-fit in 0,86 mounting hole</p>	<p>1931 1931-1-00-15-00-00-03-0 Flat face Target contact, solder Tail Hex press-fit in 0,86 mounting hole</p>
<p>1953 1953-0-00-XX-00-00-03-0 Flat face Target contact, surface mount Press-fit in 1,42 mounting hole</p>	<p>1954 1954-0-00-XX-00-00-03-0 Flat face Target contact, surface mount Press-fit in 1,42 mounting hole</p>	<p>1955 1955-0-00-15-00-00-03-0 Concave face Target contact, surface mount Press-fit in 1,42 mounting hole</p>	<p>1957 1957-0-00-15-00-00-03-0 Concave face Target contact, surface mount Press-fit in 1,42 mounting hole</p>
<p>1933 1933-0-00-XX-00-00-03-0 Flat face Target contact, solder Tail Press-fit in 0,86 mounting hole</p>	<p>1935 1935-0-00-XX-00-00-03-0 Flat face Target contact, surface mount Press-fit in 0,86 mounting hole</p>	<p>1934 1934-0-00-15-00-00-03-0 Concave face Target contact, solder Tail Press-fit in 0,86 mounting hole</p>	<p>1936 1936-0-00-15-00-00-03-0 Concave face Target contact, surface mount Press-fit in 0,86 mounting hole</p>

SPECIFICATIONS:

Pin Material: Brass Alloy 360, 1/2 Hard
(Except where noted)

Dimensions: Millimeters

Tolerances On: Lengths: $\pm 0,13$
Diameters: $\pm 0,051$
Angles: $\pm 2^\circ$



ORDER CODE: **XXXX - 0 - 00 - XX - 00 - 00 - 03 - 0**

BASIC PART #

SPECIFY PIN FINISH:

- 01 5,08 μ m TIN/LEAD OVER NICKEL
- ◆ 80 5,08 μ m TIN OVER NICKEL (RoHS)
- ◆ 15 0,25 μ m GOLD OVER NICKEL (RoHS)
- ◆ 21 0,51 μ m GOLD OVER NICKEL (RoHS)
- ◆ 34 1,27 μ m GOLD OVER NICKEL (RoHS)



MALE PCB PINS

PRINTED CIRCUIT PINS

1140

1140-0-01-XX-00-00-03-0

Press-fit in 1,45 mounting hole
For wire sizes up to 20 AWG

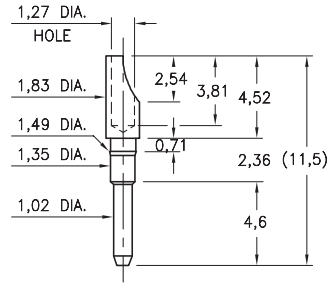

1160

1160-0-01-XX-00-00-03-0

Press-fit in 2,03 mounting hole
For wire sizes up to 16 AWG

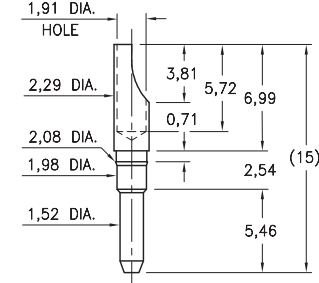

1178

1178-0-01-XX-00-00-03-0

Press-fit in 2,54 mounting hole
For wire sizes up to 14 AWG

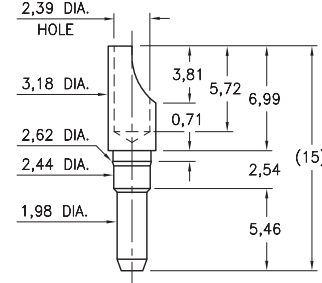

4658

4658-0-00-XX-00-00-08-0

Swage mount 1,09 mounting hole

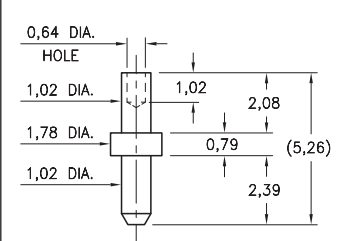

4275

4275-0-00-XX-00-00-08-0

Swage mount 1,09 mounting hole

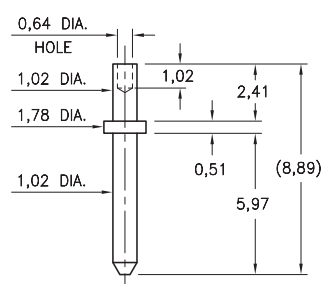

9103

9103-0-00-XX-00-00-08-0

Swage mount 1,09 mounting hole

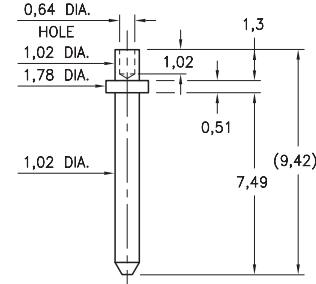

4357

4357-0-00-XX-00-00-03-0

Solder mount 1,63 mounting hole

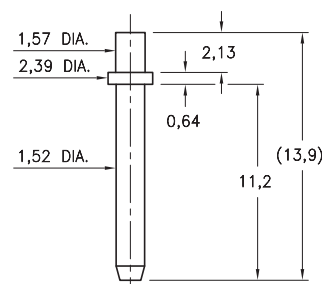

9242

9242-0-00-XX-00-00-08-0

Swage mount 2,39 mounting hole

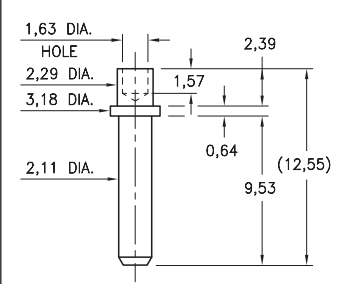

4639/4717

4XXX-0-00-XX-00-00-08-0

Swage mount 1,65 mounting hole

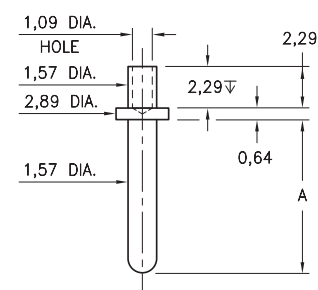

Basic Part Number	Pin Length A
4639-0	10,97
4717-0	8,43

3169

3169-0-61-15-00-00-03-0

Pins are mounted on a removable Kapton tape carrier at 2,54 pitch.
Packaged on continuous strip spools of 1,000 pins.
(Contact distributors for other order quantity options.)

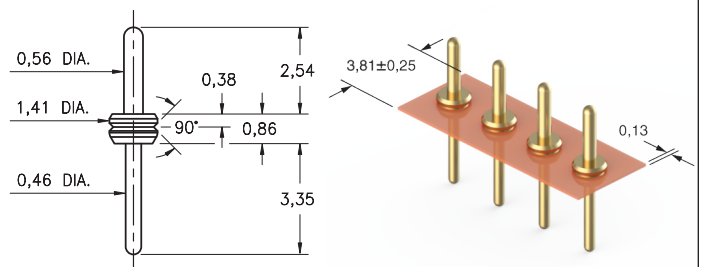

SPECIFICATIONS:

Pin Material: Brass Alloy 360, 1/2 Hard
(Except where noted)

Dimensions: Millimeters

Tolerances On: Lengths: $\pm 0,13$
Diameters: $\pm 0,051$
Angles: $\pm 2^\circ$



ORDER CODE: XXXX - 0 - 00 - XX - 00 - 00 - 03 - 0

BASIC PART #

SPECIFY PIN FINISH:

- 01 5,08 μ m TIN/LEAD OVER NICKEL
- ◆ 80 5,08 μ m TIN OVER NICKEL (RoHS)
- ◆ 15 0,25 μ m GOLD OVER NICKEL (RoHS)
- ◆ 21 0,51 μ m GOLD OVER NICKEL (RoHS)
- ◆ 34 1,27 μ m GOLD OVER NICKEL (RoHS)



MALE PCB PINS

PRINTED CIRCUIT PINS

5920

5920-0-00-XX-00-00-03-0

Solderless press-fit pin for plated through-hole
Recommended drilled hole size: 2,18mm (.086")

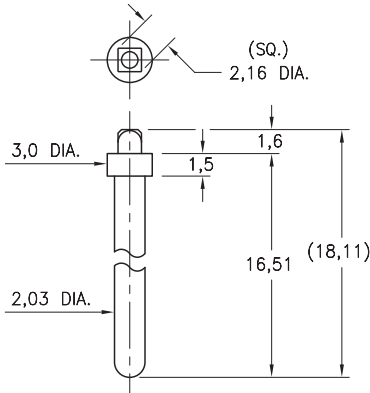

6025

6025-0-00-XX-00-00-03-0

Solderless press-fit pin for plated through-hole
Recommended drilled hole size: 1,73mm (.068")

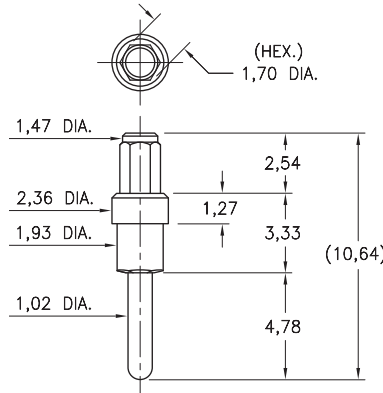

6035

6035-0-00-XX-00-00-03-0

Solderless press-fit pin for plated through-hole
Recommended drilled hole size: 1,73mm (.068")

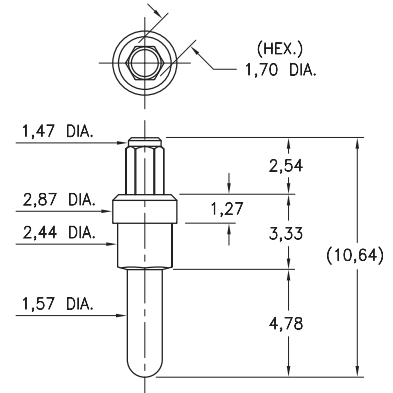

8237

8237-0-05-XX-00-00-03-0

Solderless press-fit pin for plated through-hole
Recommended drilled hole size: 2,34mm (.092")

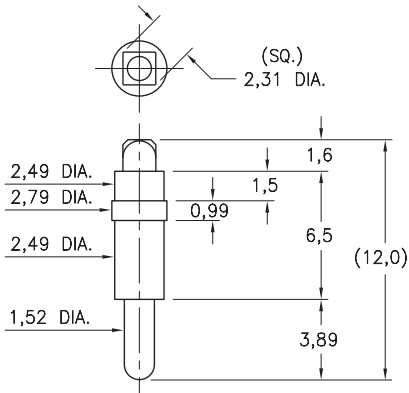

6834

6834-0-00-XX-00-00-03-0

Solderless press-fit pin for plated through-hole
Recommended drilled hole size: 1,3mm (.0512")

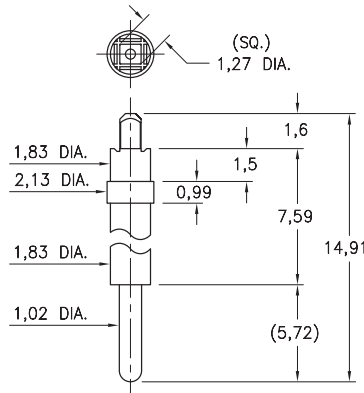

6835

6835-0-00-XX-00-00-44-0

Solderless press-fit pin for plated through-hole
Recommended drilled hole size: 2,34mm (.092")
* Pin Material: Tellurium Copper Alloy

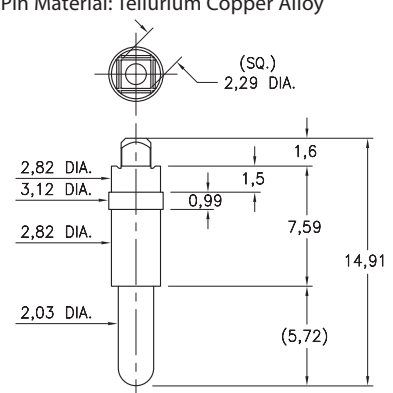

Recommended drilled hole sizes are prior to plating of the PCB and based on typical copper deposition of .5 - 1 oz. This results in a reduction of hole size by approximately 0,038 - 0,076. Depending on surface plating, typical finished hole sizes are 0,076 - 0,127 smaller than drilled hole sizes. The finished hole size tolerance for press-fit applications should be specified as +/- 0,051

SPECIFICATIONS:

Pin Material: Brass Alloy 360, 1/2 Hard
(Except where noted) *

Dimensions: Millimeters

Tolerances On: Lengths: ± 0,13
Diameters: ± 0,051
Angles: ± 2°



ORDER CODE: XXXX - 0 - 0X - XX - 00 - 00 - XX - 0

BASIC PART # →

SPECIFY PIN FINISH:

- 01 5,08µm TIN/LEAD OVER NICKEL
- ◆ 80 5,08µm TIN OVER NICKEL (RoHS)
- ◆ 15 0,25µm GOLD OVER NICKEL (RoHS)
- ◆ 21 0,51µm GOLD OVER NICKEL (RoHS)
- ◆ 34 1,27µm GOLD OVER NICKEL (RoHS)



MALE PCB PINS

PRINTED CIRCUIT PINS

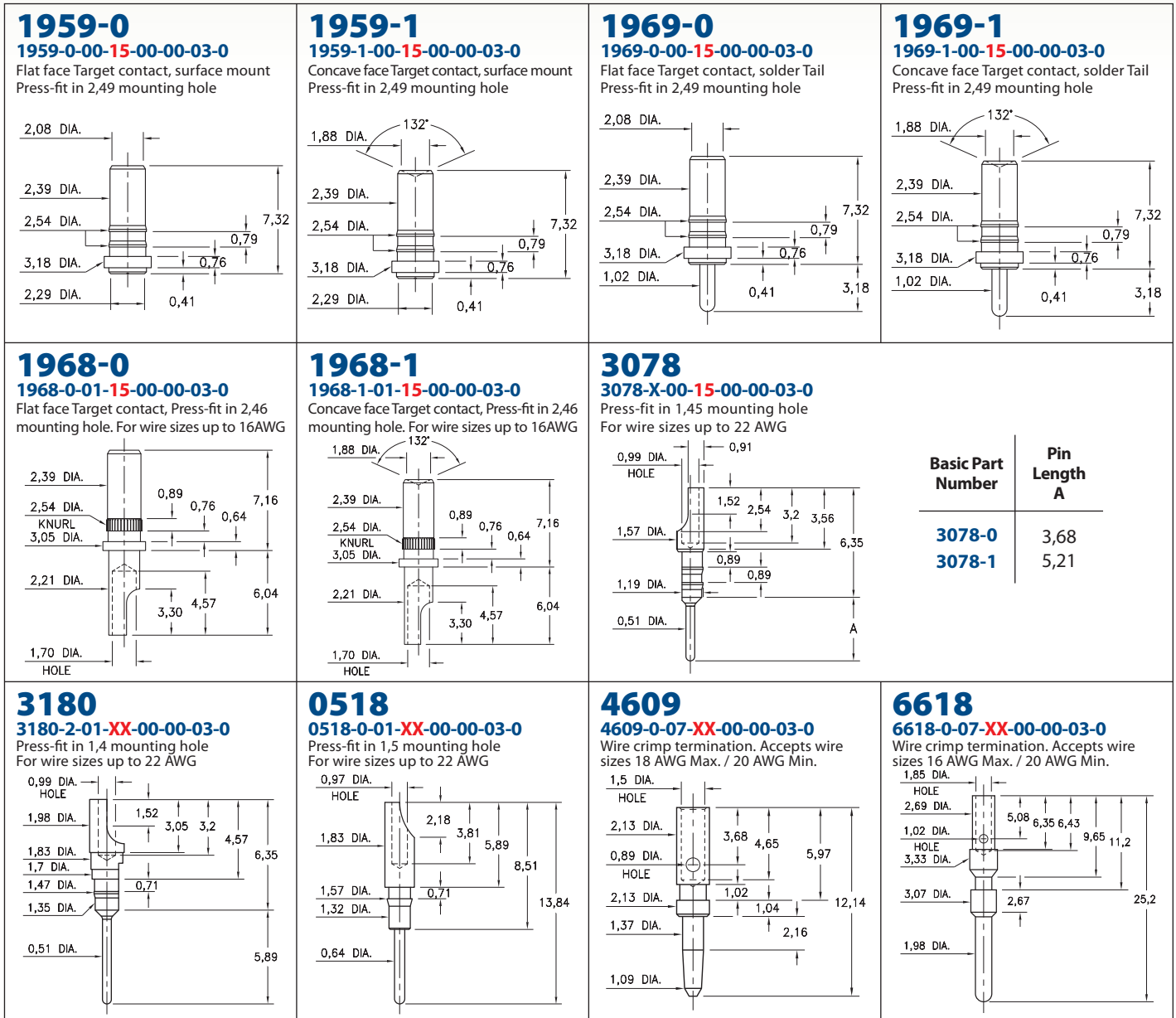

SPECIFICATIONS:

Pin Material: Brass Alloy 360, 1/2 Hard
(Annealed)

Dimensions: Millimeters

Tolerances On: Lengths: $\pm 0,13$
Diameters: $\pm 0,051$
Angles: $\pm 2^\circ$



ORDER CODE: XXXX - 0 - 00 - XX - 00 - 00 - 03 - 0

BASIC PART #

SPECIFY PIN FINISH:

- 01 5,08 μ m TIN/LEAD OVER NICKEL
- ◆ 80 5,08 μ m TIN OVER NICKEL (RoHS)
- ◆ 15 0,25 μ m GOLD OVER NICKEL (RoHS)
- ◆ 21 0,51 μ m GOLD OVER NICKEL (RoHS)
- ◆ 34 1,27 μ m GOLD OVER NICKEL (RoHS)



MALE PCB PINS

CRIMP PINS FOR 12-28 AWG WIRE

3922

3922-0-01-XX-00-00-08-0

Wire crimp termination. Accepts wire sizes 22 AWG Max. / 28 AWG Min.

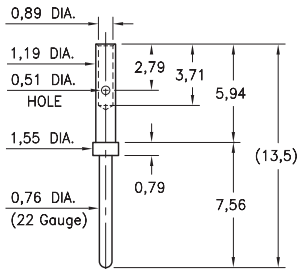

Dimensions per M39029/58-360

3920

3920-0-01-XX-00-00-08-0

Wire crimp termination. Accepts wire sizes 20 AWG Max. / 24 AWG Min.

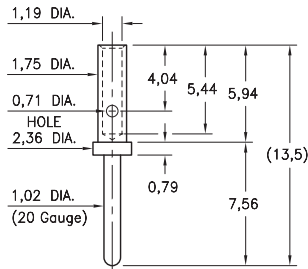

Dimensions per M39029/58-363

3916

3916-0-01-XX-00-00-08-0

Wire crimp termination. Accepts wire sizes 16 AWG Max. / 20 AWG Min.

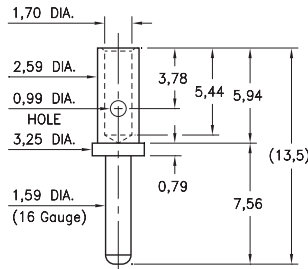

Dimensions per M39029/58-364

3914

3914-0-01-XX-00-00-08-0

Wire crimp termination. Accepts wire sizes 16 AWG Max. / 20 AWG Min.

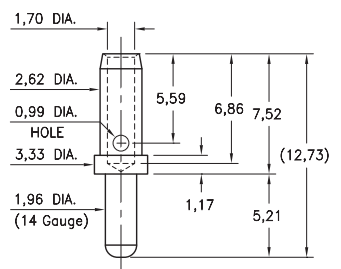

Dimensions per M39029/1-102

3912

3912-0-01-XX-00-00-08-0

Wire crimp termination. Accepts wire sizes 12 AWG Max. / 14 AWG Min.

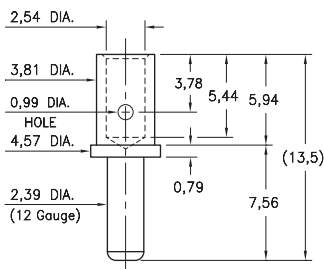

Dimensions per M39029/58-365

SPECIFICATIONS:

Pin Material: Brass Alloy 360, 1/2 Hard (Annealed)

Dimensions: Millimeters

Tolerances On: Lengths: $\pm 0,13$
Diameters: $\pm 0,051$
Angles: $\pm 2^\circ$



ORDER CODE: 39XX - X - 01 - XX - 00 - 00 - 08 - 0

BASIC PART #

SPECIFY PIN FINISH:

- 01 5,08 μ m TIN/LEAD OVER NICKEL
- ◆ 80 5,08 μ m TIN OVER NICKEL (RoHS)
- ◆ 15 0,25 μ m GOLD OVER NICKEL (RoHS)
- ◆ 21 0,51 μ m GOLD OVER NICKEL (RoHS)
- ◆ 34 1,27 μ m GOLD OVER NICKEL (RoHS)



MALE PCB PINS

PRINTED CIRCUIT PINS

3975

3975-0-00-XX-00-00-03-0

Solderless press-fit pin for plated through-hole
Recommended drilled hole size: (1,78mm) .070"

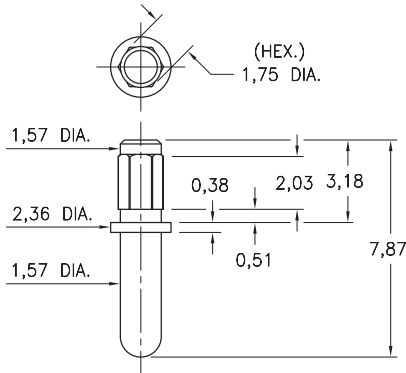

3977

3977-0-00-XX-00-00-03-0

Solderless press-fit pin for plated through-hole
Recommended drilled hole size: (1,78mm) .070"

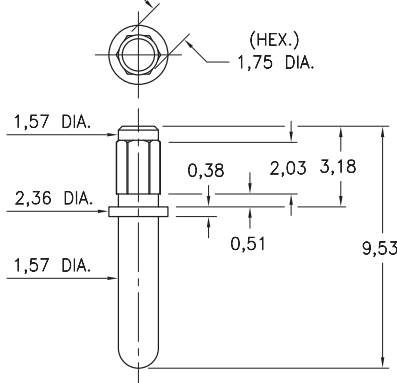

4427

4427-0-00-XX-00-00-03-0

Solderless press-fit pin for plated through-hole
Recommended drilled hole size: (1,73mm) .068"

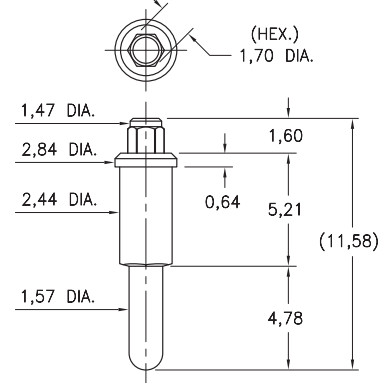

7504

7504-0-00-XX-00-00-03-0

Solderless press-fit pin for plated through-hole
Recommended drilled hole size: (1,73mm) .068"

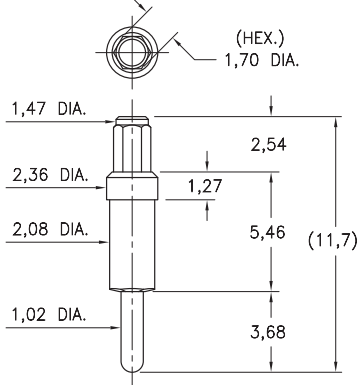

9003

9003-0-00-XX-00-00-03-0

Solderless press-fit pin for plated through-hole
Recommended drilled hole size: (1,19mm) .047"

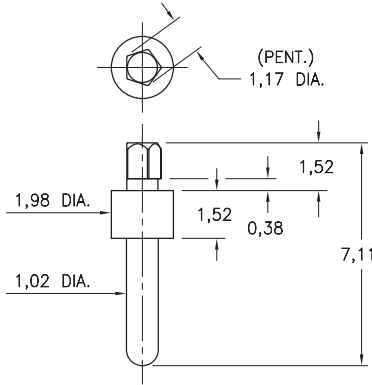

6955

6955-0-05-XX-00-00-03-0

Solderless press-fit pin for plated through-hole
Recommended drilled hole size: (2,31mm) .091"

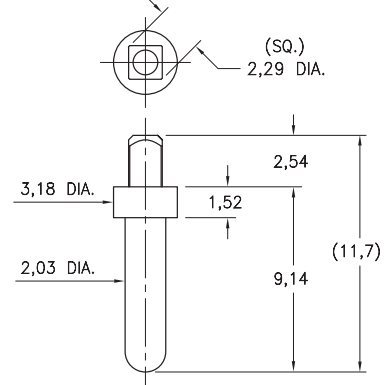

Recommended drilled hole sizes are prior to plating of the PCB and based on typical copper deposition of .5 - 1 oz. This results in a reduction of hole size by approximately 0,038 - 0,076. Depending on surface plating, typical finished hole sizes are 0,076 - 0,127 smaller than drilled hole sizes. The finished hole size tolerance for press-fit applications should be specified as +/- 0,051

SPECIFICATIONS:

Pin Material: Brass Alloy 360, 1/2 Hard
(Except where noted) *

Dimensions: Millimeters

Tolerances On: Lengths: $\pm 0,13$
Diameters: $\pm 0,051$
Angles: $\pm 2^\circ$



ORDER CODE: XXXX - 0 - 0X - XX - 00 - 00 - XX - 0

BASIC PART # →

SPECIFY PIN FINISH:

- 01** 5,08 μ m TIN/LEAD OVER NICKEL
- ◆ **80** 5,08 μ m TIN OVER NICKEL (RoHS)
- ◆ **15** 0,25 μ m GOLD OVER NICKEL (RoHS)
- ◆ **21** 0,51 μ m GOLD OVER NICKEL (RoHS)
- ◆ **34** 1,27 μ m GOLD OVER NICKEL (RoHS)



MALE PCB PINS

PRINTED CIRCUIT PINS

1655

1655-0-00-XX-00-00-03-0

Solderless press-fit pin for plated through-hole
Recommended drilled hole size: (1,28mm) .0505"

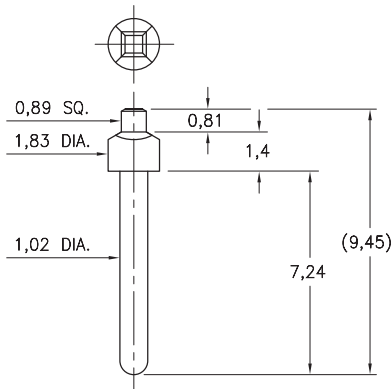

4219

4219-0-05-XX-00-00-03-0

Solderless press-fit pin for plated through-hole
Recommended drilled hole size: (1,28mm) .0505"

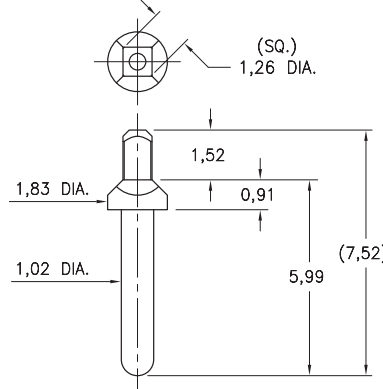

5459

5459-0-00-XX-00-00-03-0

Solderless press-fit pin for plated through-hole
Recommended drilled hole size: (1,3mm) .051"

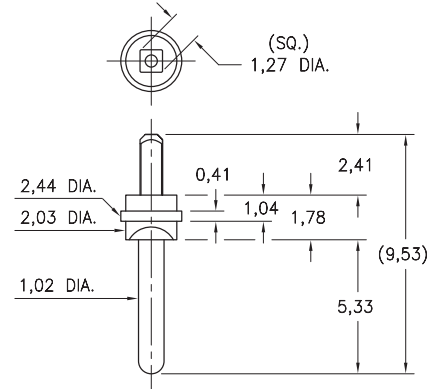

9061

9061-0-00-XX-00-00-03-0

Solderless press-fit pin for plated through-hole
Recommended drilled hole size: (1,28mm) .0505"

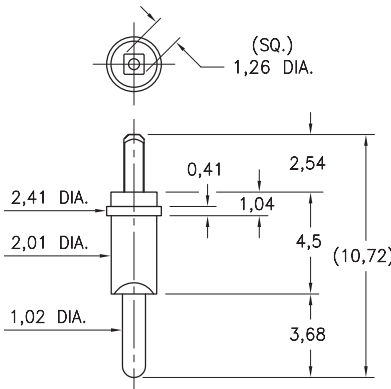

5316

5316-0-00-XX-00-00-03-0

Solderless press-fit pin for plated through-hole
Recommended drilled hole size: (1,02mm) .040"

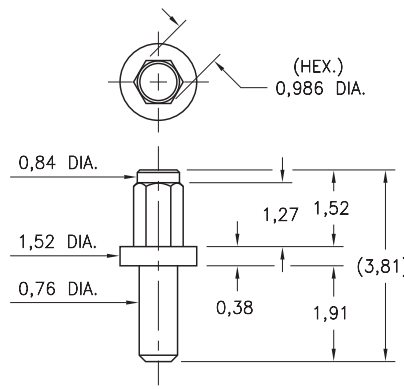

Recommended drilled hole sizes are prior to plating of the PCB and based on typical copper deposition of .5 - 1 oz. This results in a reduction of hole size by approximately 0,038 - 0,076. Depending on surface plating, typical finished hole sizes are 0,076 - 0,127 smaller than drilled hole sizes. The finished hole size tolerance for press-fit applications should be specified as +/- 0,051

SPECIFICATIONS:

Pin Material: Brass Alloy 360, 1/2 Hard
(Except where noted) *

Dimensions: Millimeters

Tolerances On: Lengths: ± 0,13
Diameters: ± 0,051
Angles: ± 2°



ORDER CODE: XXXX - 0 - 0X - XX - 00 - 00 - 03 - 0

BASIC PART # →

SPECIFY PIN FINISH:

- 01 5,08µm TIN/LEAD OVER NICKEL
- ◆ 80 5,08µm TIN OVER NICKEL (RoHS)
- ◆ 15 0,25µm GOLD OVER NICKEL (RoHS)
- ◆ 21 0,51µm GOLD OVER NICKEL (RoHS)
- ◆ 34 1,27µm GOLD OVER NICKEL (RoHS)

MALE PCB PINS

PRINTED CIRCUIT PINS

4118

4118-0-00-XX-00-00-03-0

Solderless press-fit pin for plated through-hole
Recommended drilled hole size: (0,75mm) .0295"

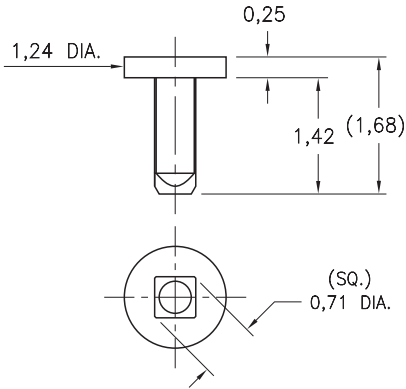

5317

5317-0-00-XX-00-00-03-0

Solderless press-fit pin for plated through-hole
Recommended drilled hole size: (1,02mm) .040"

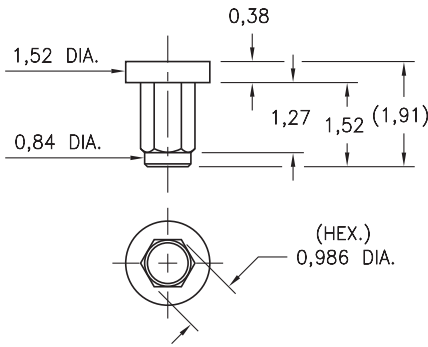

Recommended drilled hole sizes are prior to plating of the PCB and based on typical copper deposition of .5 - 1 oz. This results in a reduction of hole size by approximately .0015" - .003". Depending on surface plating, typical finished hole sizes are .003" - .005" smaller than drilled hole sizes. The finished hole size tolerance for press-fit applications should be specified as +/- .002"

SPECIFICATIONS:

Pin Material: Brass Alloy 360, 1/2 Hard
(Except where noted) *

Dimensions: Inches

Tolerances On: Lengths: ±.005
Diameters: ±.002
Angles: ±2°



ORDER CODE: XXXX - 0 - 0X - XX - 00 - 00 - XX - 0

BASIC PART #

SPECIFY PIN FINISH:

- 01 200 μ" TIN/LEAD OVER NICKEL
- ◆ 80 200 μ" TIN OVER NICKEL (RoHS)
- ◆ 15 10 μ" GOLD OVER NICKEL (RoHS)
- ◆ 21 20 μ" GOLD OVER NICKEL (RoHS)
- ◆ 34 50 μ" GOLD OVER NICKEL (RoHS)

MALE PCB PINS

PRINTED CIRCUIT PINS

5231

5231-0-00-XX-00-00-38-0

Swage mount in 2,39 hole
For a 3,18 thick board

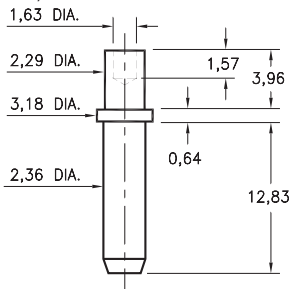

9092

9092-0-00-XX-00-00-38-0

Wire crimp termination up to 14 AWG

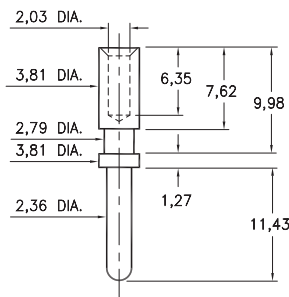

7310

7310-0-01-XX-00-00-08-0

Board edge press-fit

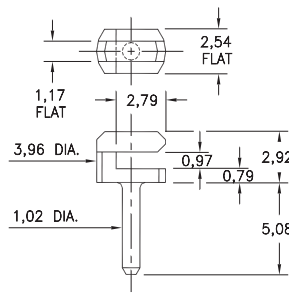

5066

5066-0-00-26-00-00-03-0

Press-fit in 1,09 mounting hole

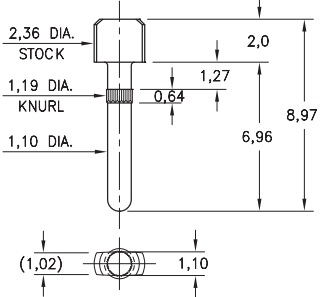

7937

7937-0-00-15-00-00-03-0

Target contact, horizontal surface mount
Also available on 16mm wide carrier tape:

2,400 parts per 330mm reel.
See page 224.4 for Tape & Reel details

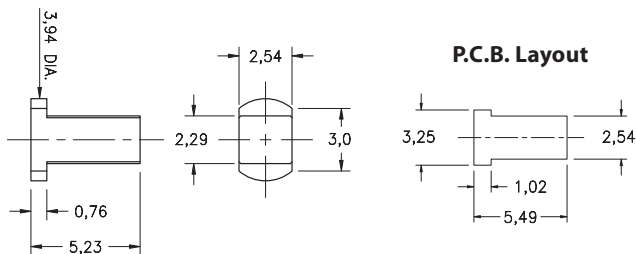

1502

1502-0-00-XX-00-00-03-0

Press-fit in 1,45 mounting hole

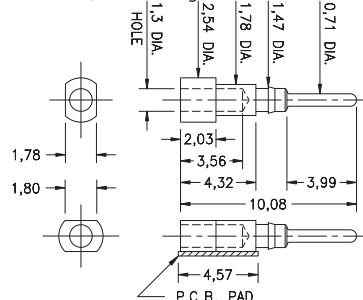

P.C.B. Layout

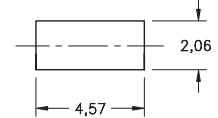

5102

5102-0-00-XX-00-00-33-0

Press-fit in 1,45 mounting hole

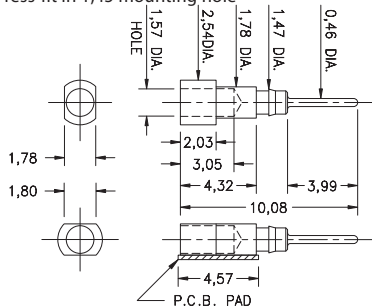

P.C.B. Layout

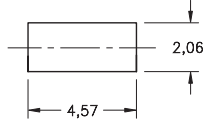

1508

1508-0-00-15-00-00-03-0

Test point, surface mount
Also available on 16mm wide carrier tape:

1,600 parts per 330mm reel.
See page 224.4 for Tape & Reel details

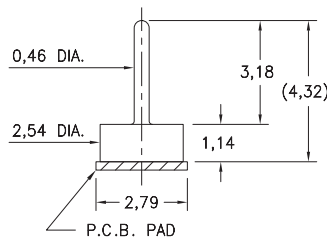

P.C.B. Layout

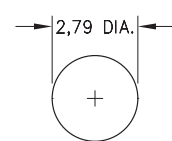

SPECIFICATIONS:

Pin Material: Brass Alloy 360, 1/2 Hard
(Except swage pins which are annealed)

Dimensions: Millimeters

Tolerances On: Lengths: $\pm 0,13$
Diameters: $\pm 0,051$
Angles: $\pm 2^\circ$



ORDER CODE: **XXXX - X - 0X - XX - 00 - 00 - XX - 0**

BASIC PART #

SPECIFY PIN FINISH:

- 01 5,08 μ m TIN/LEAD OVER NICKEL
- ◆ 80 5,08 μ m TIN OVER NICKEL (RoHS)
- ◆ 15 0,25 μ m GOLD OVER NICKEL (RoHS)
- ◆ 21 0,51 μ m GOLD OVER NICKEL (RoHS)
- ◆ 34 1,27 μ m GOLD OVER NICKEL (RoHS)



MALE PCB PINS

PINS ON TAPE & REEL PACKAGING

4825

4825-0-57-XX-00-00-33-0

Solder mount in 0,48 mounting hole
16mm wide X 8mm pitch carrier tape:
3,250 parts per 330mm reel.

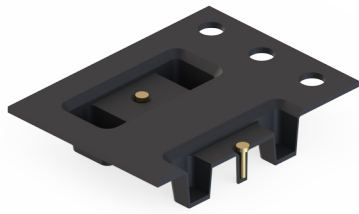
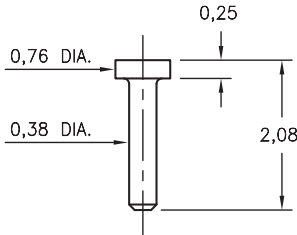

4288

4288-0-57-XX-00-00-33-0

Solder mount in 0,48 mounting hole
16mm wide X 8mm pitch carrier tape:
3,250 parts per 330mm reel.

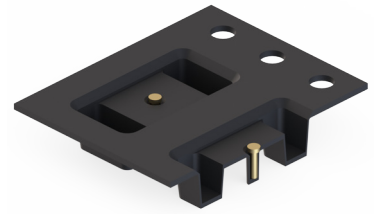
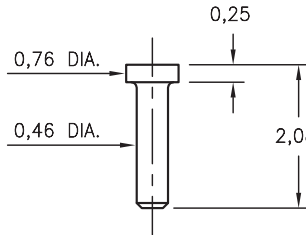

4353

4353-0-57-XX-00-00-33-0

Solder mount in 0,41 mounting hole
16mm wide X 8mm pitch carrier tape:
3,040 parts per 330mm reel.

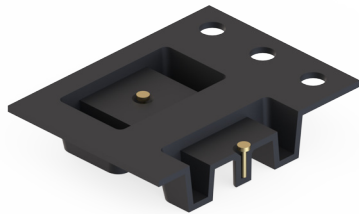
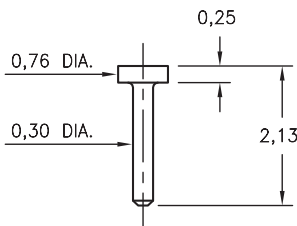

4068

4068-0-57-XX-00-00-33-0

Solder mount in 0,56 mounting hole
16mm wide X 8mm pitch carrier tape:
2,000 parts per 330mm reel.

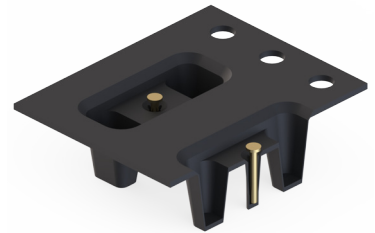
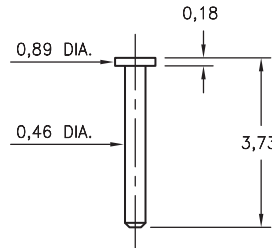

6547

6547-0-57-XX-00-00-33-0

Solder mount in 0,61 mounting hole
24mm wide X 8mm pitch carrier tape:
1,080 parts per 330mm reel.

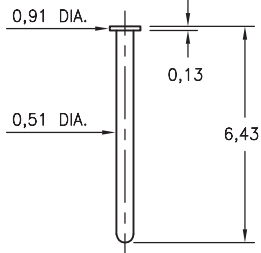

9083

9083-0-57-XX-00-00-38-0

Solder mount in 0,41 mounting hole
16mm wide X 8mm pitch carrier tape:
1,950 parts per 330mm reel.

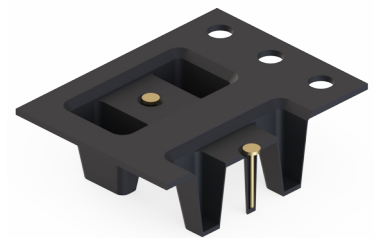
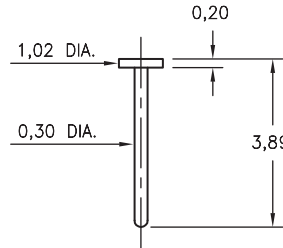

SPECIFICATIONS:

Pin Material: Brass Alloy 360, 1/2 Hard
(Except where noted)

Dimensions: Millimeters

Tolerances On: Lengths: $\pm 0,13$
Diameters: $\pm 0,051$
Angles: $\pm 2^\circ$



ORDER CODE: XXXX - X - 00 - XX - 00 - 00 - XX - 0

BASIC PART # →

SPECIFY PIN FINISH:

- 01 5,08 μ m TIN/LEAD OVER NICKEL
- ◆ 80 5,08 μ m TIN OVER NICKEL (RoHS)
- ◆ 15 0,25 μ m GOLD OVER NICKEL (RoHS)
- ◆ 21 0,51 μ m GOLD OVER NICKEL (RoHS)
- ◆ 34 1,27 μ m GOLD OVER NICKEL (RoHS)



MALE PCB PINS

PINS ON TAPE & REEL PACKAGING

5058

5058-0-57-XX-00-00-03-0

Solder mount in 0,61 mounting hole
16mm wide X 8mm pitch carrier tape:
2,000 parts per 330mm reel.

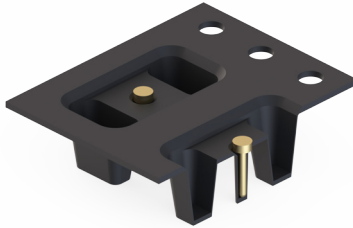
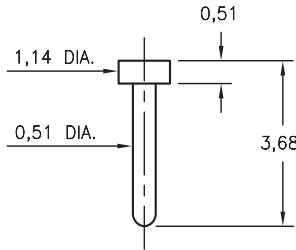

9113

9113-0-57-XX-00-00-38-0

Solder mount in 0,56 mounting hole
16mm wide X 8mm pitch carrier tape:
1,800 parts per 330mm reel.

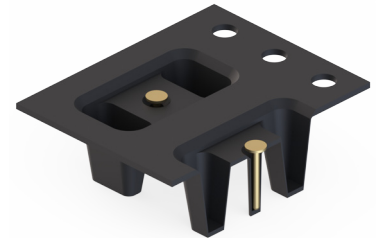
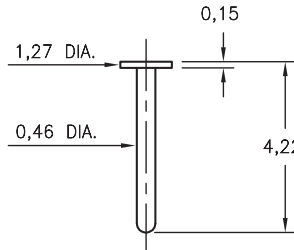

4965

4965-0-57-XX-00-00-33-0

Solder mount in 0,61 mounting hole
24mm wide X 8mm pitch carrier tape:
1,300 parts per 330mm reel.

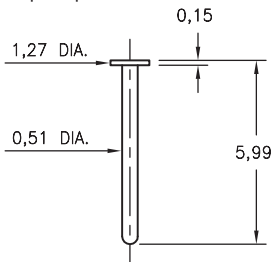

4361

4361-0-57-XX-00-00-33-0

Solder mount in 0,48 mounting hole
16mm wide X 8mm pitch carrier tape:
3,600 parts per 330mm reel.

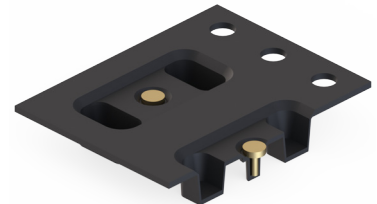
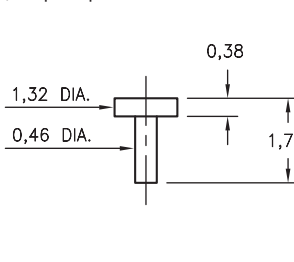

4477

4477-0-57-XX-00-00-33-0

Solder mount in 0,86 mounting hole
24mm wide X 8mm pitch carrier tape:
1,300 parts per 330mm reel.

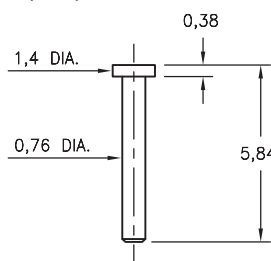

3137

3137-1-57-XX-00-00-08-0

Solder mount in 1,09 mounting hole
16mm wide X 12mm pitch carrier tape:
580 parts per 330mm reel.

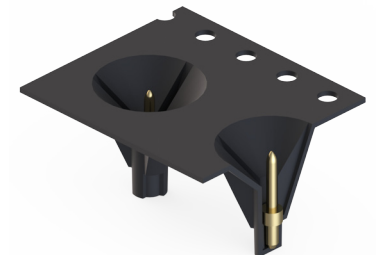
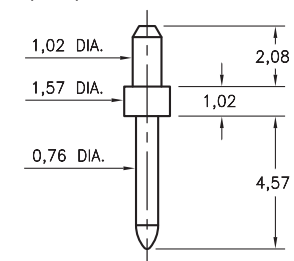

SPECIFICATIONS:

Pin Material: Brass Alloy 360, 1/2 Hard
(Except where noted)

Dimensions: Millimeters

Tolerances On: Lengths: $\pm 0,13$
Diameters: $\pm 0,051$
Angles: $\pm 2^\circ$



ORDER CODE: XXXX - X - 00 - XX - 00 - 00 - XX - 0

BASIC PART #

SPECIFY PIN FINISH:

◆ 15 0,25 μ m GOLD OVER NICKEL (RoHS)



MALE PCB PINS

8330

8330-0-57-XX-00-00-03-0

Solder mount in 1,12 mounting hole
24mm wide X 12mm pitch carrier tape:
610 parts per 330mm reel.

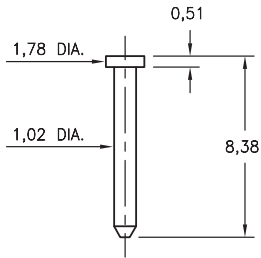

0286

0286-0-57-XX-00-00-03-0

Press-fit in 1,45 mounting hole
16mm wide X 8mm pitch carrier tape:
2,500 parts per 330mm reel.

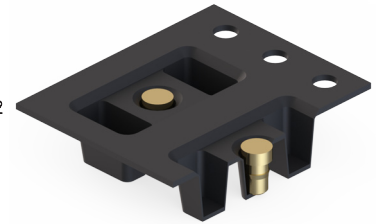
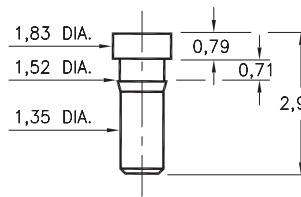

9265

9265-0-57-XX-00-00-38-0

Solder mount in 1,6 mounting hole
16mm wide X 8mm pitch carrier tape:
1,170 parts per 330mm reel.

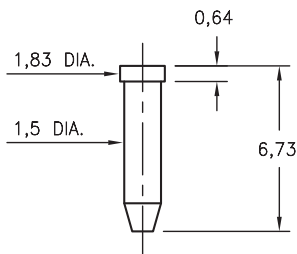

2381

2381-0-57-XX-00-00-33-0

Solder mount in 1,37 mounting hole
16mm wide X 8mm pitch carrier tape:
1,800 parts per 330mm reel.

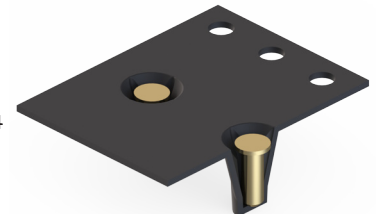
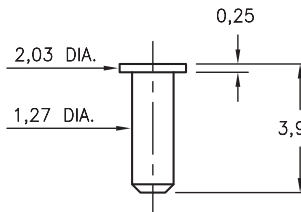

1944

1944-0-57-15-00-00-03-0

Flat face Target contact, surface mount
16mm wide X 8mm pitch carrier tape:
2,200 parts per 330mm reel.

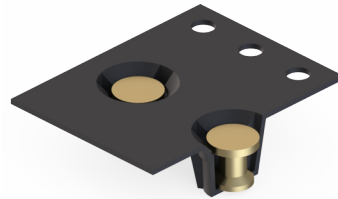
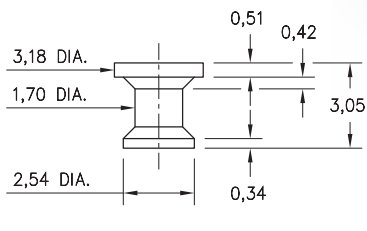

P.C.B. Layout

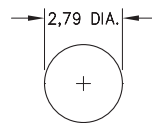

1943

1943-0-57-15-00-00-03-0

Concave face Target contact, surface mount
16mm wide X 8mm pitch carrier tape:
2,200 parts per 330mm reel.

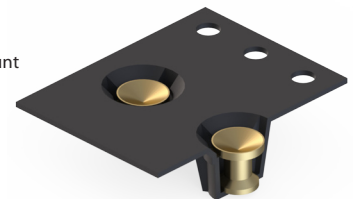
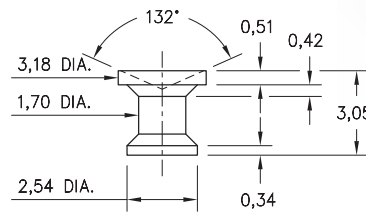

P.C.B. Layout

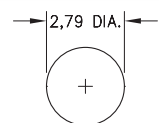

SPECIFICATIONS:

Pin Material: Brass Alloy 360, 1/2 Hard
(Except where noted)

Dimensions: Millimeters

Tolerances On: Lengths: $\pm .005$
Diameters: $\pm .002$
Angles: $\pm 2^\circ$



ORDER CODE: XXXX - X - 00 - XX - 00 - 00 - XX - 0

BASIC PART # →

SPECIFY PIN FINISH:

- 01 200 μ " TIN/LEAD OVER NICKEL
- ◆ 80 200 μ " TIN OVER NICKEL (RoHS)
- ◆ 15 10 μ " GOLD OVER NICKEL (RoHS)
- ◆ 21 20 μ " GOLD OVER NICKEL (RoHS)
- ◆ 34 50 μ " GOLD OVER NICKEL (RoHS)



MALE PCB PINS

9022

9022-0-57-XX-00-00-33-0

Solder mount in 1,68 mounting hole
24mm wide X 8mm pitch carrier tape:
1,500 parts per 330mm reel.

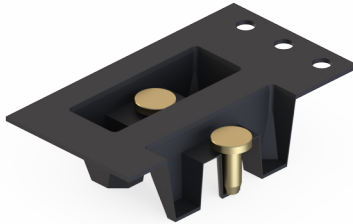
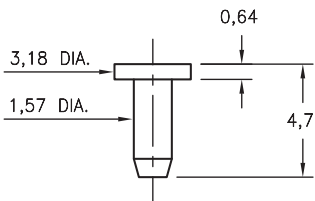

7937

7937-0-58-15-00-00-03-0

Target contact, horizontal surface mount
16mm wide X 8mm pitch carrier tape:
2,400 parts per 330mm reel.

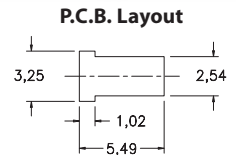
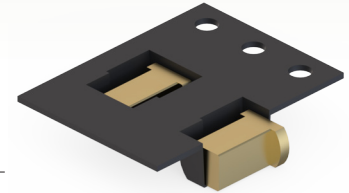
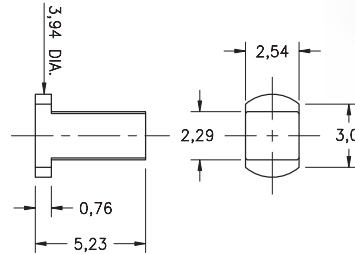

8086

8086-0-57-XX-00-00-33-0

Solder mount in 2,01 mounting hole
12mm wide X 8mm pitch carrier tape:
550 parts per 330mm reel.

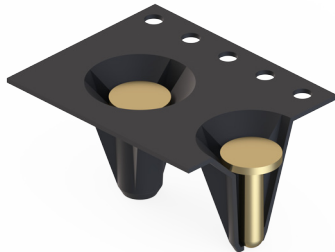
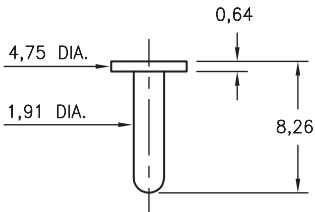

8086

8086-0-59-XX-00-00-33-0

Surface mount
24mm wide X 16mm pitch carrier tape:
450 parts per 330mm reel.

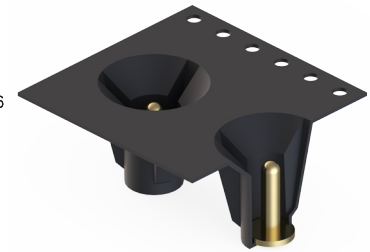
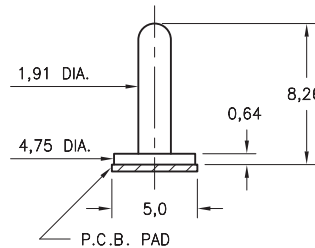

1508

1508-0-57-15-00-00-03-0

Test point, surface mount
16mm wide X 8mm pitch carrier tape:
1,600 parts per 330mm reel.

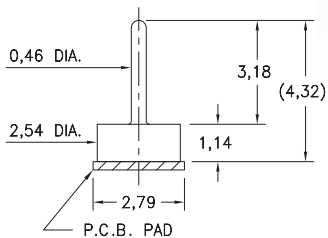

P.C.B. Layout

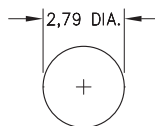

SPECIFICATIONS:

Pin Material: Brass Alloy 360, 1/2 Hard
(Except where noted)

Dimensions: Inches

Tolerances On: Lengths: ±.005
Diameters: ±.002
Angles: ± 2°



ORDER CODE: XXXX - X - 00 - XX - 00 - 00 - XX - 0

BASIC PART #

SPECIFY PIN FINISH:

◆ 15 10 μ" GOLD OVER NICKEL (RoHS)



MALE PCB PINS

WRAPOST TERMINALS

5275

5275-X-05-XX-00-00-01-0

Square press-fit in 0,89 plated through-hole

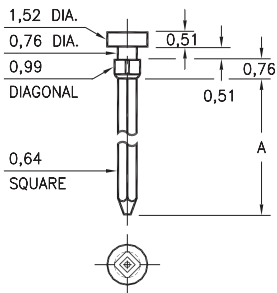

Basic Part Number	# of Wraps	Length A
5275-1	1	9,40
5275-2	2	11,94
5275-3	3	15,49

1010 ⇔ 1012/1020 ⇔ 1022

10XX-X-05-XX-00-00-01-0

Press-fit in 1,45 mounting hole

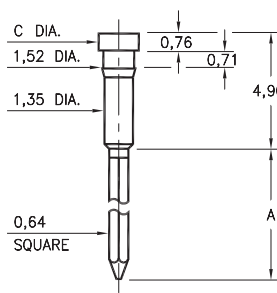

Basic Part Number	# of Wraps	Wrapost Length A	Head Dia. C
1012-1	1	6,60	1,83
1011-2	2	9,14	
1010-3	3	12,7	
1022-1	1	6,60	1,57
1021-2	2	9,14	
1020-3	3	12,7	

1215

1215-3-05-XX-00-00-01-0

Press-fit in 1,09 mounting hole

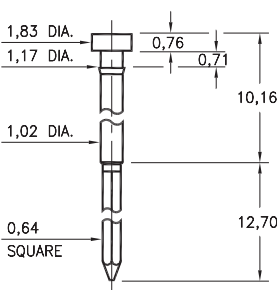

1124

1124-0-05-XX-00-00-01-0

Press-fit in 1,09 mounting hole

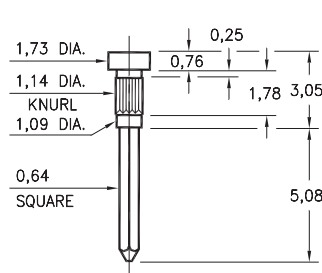

1210

1210-0-05-XX-00-00-01-0

Press-fit in 1,35 mounting hole

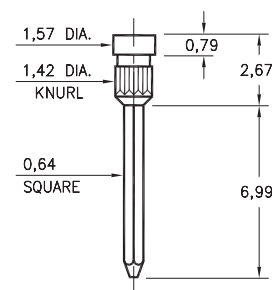

1222

1222-0-05-XX-00-00-01-0

Press-fit in 1,40 mounting hole

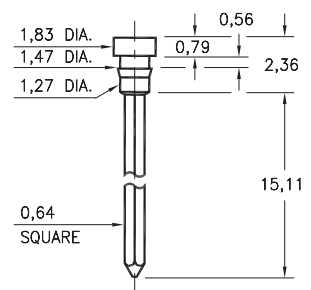

1221

1221-0-05-XX-00-00-01-0

Press-fit in 1,42 mounting hole

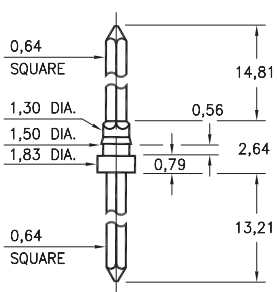

1110

1110-3-05-XX-00-00-01-0

Press-fit in 1,45 mounting hole

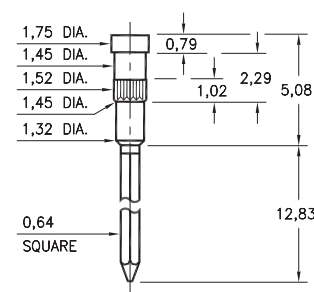

1094

1094-0-05-XX-00-00-01-0

Press-fit in 1,42 mounting hole

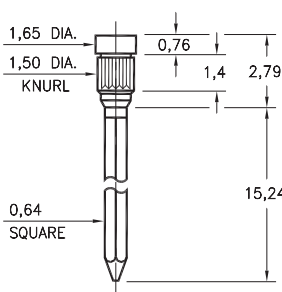

SPECIFICATIONS:

Pin Material: Brass Alloy 360, 1/2 Hard
(Except where noted)

Dimensions: Millimeters

Tolerances On: Lengths: ± 0,13
Diameters: ± 0,051
Angles: ± 2°



ORDER CODE: **XXXX - X - 05 - XX - 00 - 00 - 01 - 0**

BASIC PART #

SPECIFY PIN FINISH:

- 01 5,08µm TIN/LEAD OVER NICKEL
- ◆ 80 5,08µm TIN OVER NICKEL (RoHS)
- ◆ 15 0,25µm GOLD OVER NICKEL (RoHS)
- ◆ 21 0,51µm GOLD OVER NICKEL (RoHS)



MALE PCB PINS

WRAPOST TERMINALS

1030 → 1032

103X-X-05-XX-00-00-01-0

Press-fit in 1,45 mounting hole

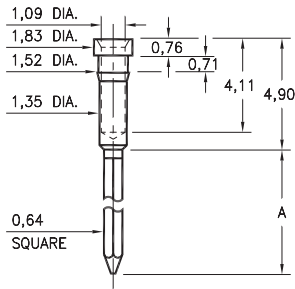

Basic Part Number	# of Wraps	Length A
1032-1	1	6,60
1031-2	2	9,14
1030-3	3	12,7

1216

1216-0-05-XX-00-00-01-0

Press-fit in 1,42 mounting hole

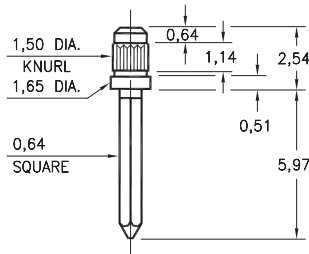

1095

1095-0-05-XX-00-00-01-0

Swage mount in 2,39 hole

For a 1,57 thick board

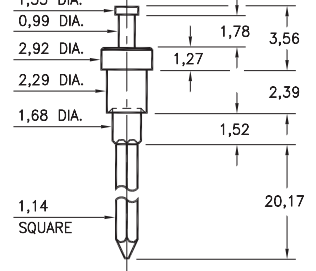

1214

1214-0-05-XX-00-00-01-0

Press-fit in 1,50 mounting hole

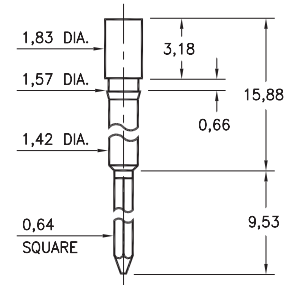

1212

1212-0-05-XX-00-00-01-0

Press-fit in 1,55 mounting hole

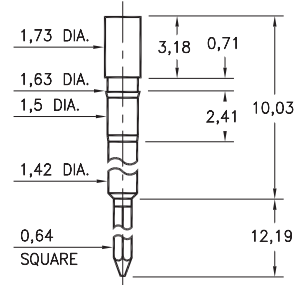

1213

1213-0-05-XX-00-00-01-0

Press-fit in 1,55 mounting hole

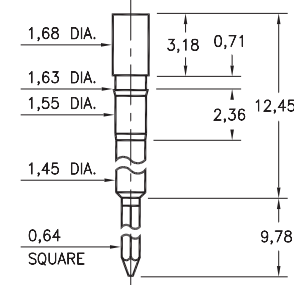

0318

0318-3-05-XX-00-00-01-0

Press-fit in 1,45 mounting hole

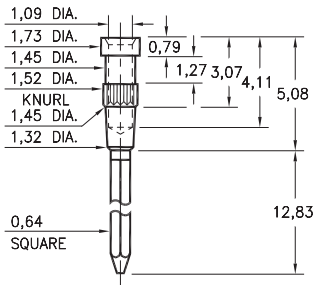

1302

1302-0-05-XX-00-00-01-0

Press-fit in 1,45 mounting hole

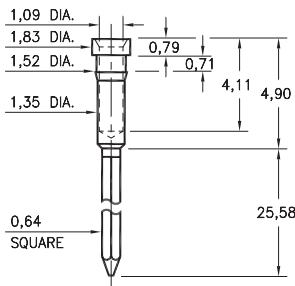

1097

1097-0-05-XX-00-00-01-0

Swage mount in 2,39 hole

For a 1,57 thick board

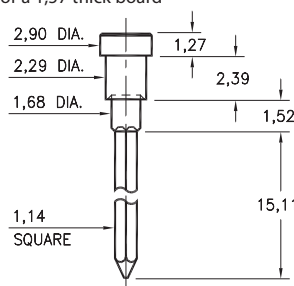

SPECIFICATIONS:

Pin Material: Brass Alloy 360, 1/2 Hard
(Except swage pins which are annealed)

Dimensions: Millimeters

Tolerances On: Lengths: ± 0,13
Diameters: ± 0,051
Angles: ± 2°



ORDER CODE: XXXX - X - 05 - XX - 00 - 00 - 01 - 0

BASIC PART #

SPECIFY PIN FINISH:

- 01 5,08µm TIN/LEAD OVER NICKEL
- ◆ 80 5,08µm TIN OVER NICKEL (RoHS)
- ◆ 15 0,25µm GOLD OVER NICKEL (RoHS)
- ◆ 21 0,51µm GOLD OVER NICKEL (RoHS)



MALE PCB PINS

WRAPOST TERMINALS

8301

8301-X-24-XX-00-00-01-0

Press-fit in 1,45 mounting hole
For wire sizes up to 22 AWG

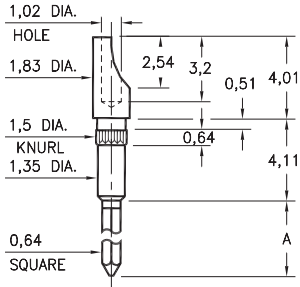

Basic Part Number	# of Wraps	Length A
8301-2	2	9,40
8301-3	3	12,95

1083

1083-0-05-XX-00-00-01-0

Press-fit in 1,50 mounting hole

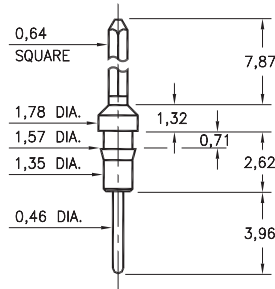

5301

5301-0-05-XX-00-00-01-0

Press-fit in 1,45 mounting hole

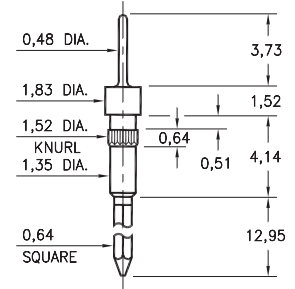

1090

1090-0-05-XX-00-00-01-0

Press-fit in 1,50 mounting hole

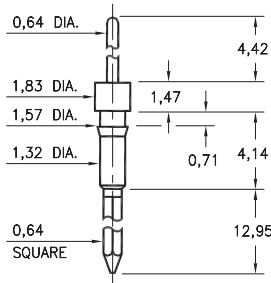

8608

8608-0-05-XX-00-00-01-0

Press-fit in 1,42 mounting hole

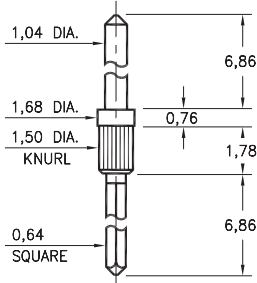

SPECIFICATIONS:

Pin Material: Brass Alloy 360, 1/2 Hard
(Except where noted)

Dimensions: Millimeters

Tolerances On: Lengths: $\pm 0,13$
Diameters: $\pm 0,051$
Angles: $\pm 2^\circ$



ORDER CODE: **XXXX - X - XX - XX - 00 - 00 - 01 - 0**

BASIC PART #

SPECIFY PIN FINISH:

- 01** 5,08 μ m TIN/LEAD OVER NICKEL
- 80** 5,08 μ m TIN OVER NICKEL (RoHS)
- 15** 0,25 μ m GOLD OVER NICKEL (RoHS)
- 21** 0,51 μ m GOLD OVER NICKEL (RoHS)



MALE PCB PINS

WRAPOST TERMINALS

1096

1096-X-05-XX-00-00-01-0

Press-fit in 1,45 mounting hole

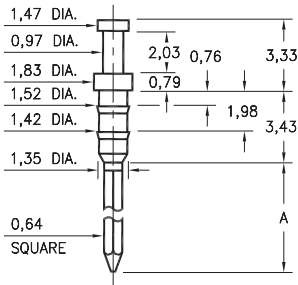

Basic Part Number	# of Wraps	Length A
1096-2	2	9,68
1096-3	3	13,39

1106

1106-X-23-XX-00-00-01-0

Press-fit in 1,45 mounting hole

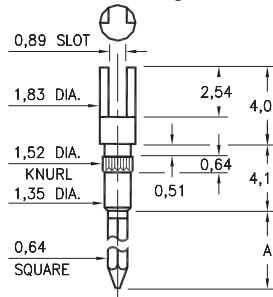

Basic Part Number	# of Wraps	Length A
1106-2	2	9,40
1106-3	3	12,95

1093

1093-0-05-XX-00-00-01-0

Press-fit in 1,42 mounting hole

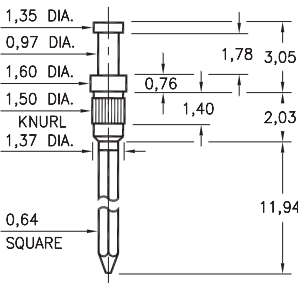

0730

0730-3-05-XX-00-00-01-0

Press-fit in 1,45 mounting hole

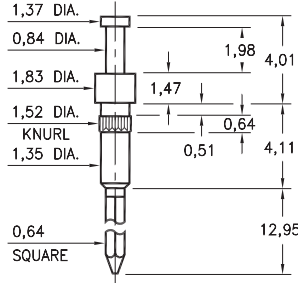

1122

1122-0-22-XX-00-00-01-0

Press-fit in 1,35 mounting hole

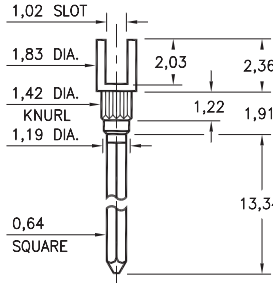

1064

1064-0-23-XX-00-00-01-0

Press-fit in 1,42 mounting hole

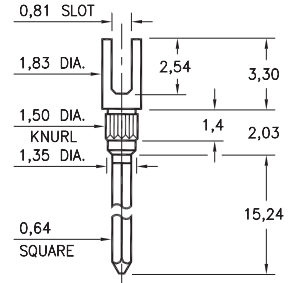

1092

1092-0-05-XX-00-00-01-0

Press-fit in 1,42 mounting hole

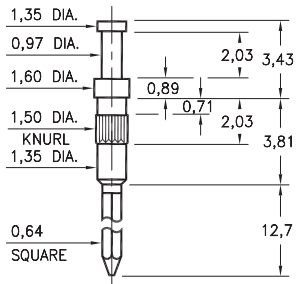

1068

1068-0-23-XX-00-00-01-0

Press-fit in 1,45 mounting hole

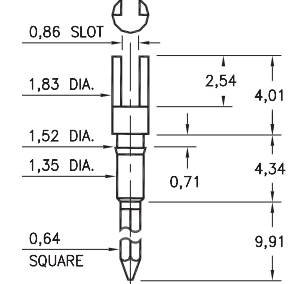

1070 → 1072

107X-X-23-XX-00-00-01-0

Press-fit in 1,45 mounting hole

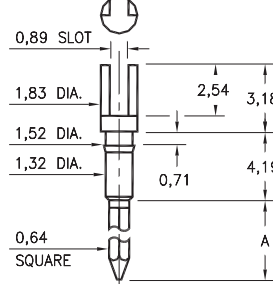

Basic Part Number	# of Wraps	Length A
1072-1	1	6,60
1071-2	2	9,40
1070-3	3	12,95

SPECIFICATIONS:

Pin Material: Brass Alloy 360, 1/2 Hard
(Except where noted)

Dimensions: Millimeters

Tolerances On: Lengths: ±0,13
Diameters: ±0,051
Angles: ±2°



ORDER CODE: XXXX - X - XX - XX - 00 - 00 - 01 - 0

BASIC PART #

SPECIFY PIN FINISH:

- 01 5,08µm TIN/LEAD OVER NICKEL
- ◆ 80 5,08µm TIN OVER NICKEL (RoHS)
- ◆ 15 0,25µm GOLD OVER NICKEL (RoHS)
- ◆ 21 0,51µm GOLD OVER NICKEL (RoHS)



MALE PCB PINS

SOLDER TERMINAL TURRETS

2111

2111-X-00-XX-00-00-07-0

Swage mount in 0,84 hole

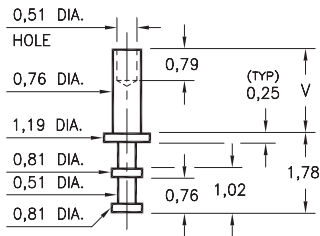

Basic Part Number	Board Thickness	Length V
2111-1	0,79	1,35
2111-2	1,57	2,13
2111-3	2,39	2,92

2113

2113-X-00-XX-00-00-07-0

Swage mount in 1,09 hole

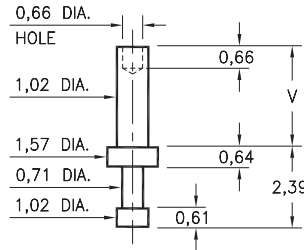

Basic Part Number	Board Thickness	Length V
2113-1	0,79	1,35
2113-2	1,57	2,13
2113-3	2,39	2,92
2113-4	3,18	3,73

2108

2108-X-00-XX-00-00-07-0

Swage mount in 1,09 hole

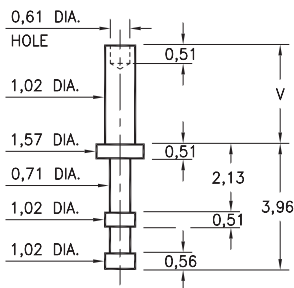

Basic Part Number	Board Thickness	Length V
2108-1	0,79	1,35
2108-2	1,57	2,13
2108-3	2,39	2,92
2108-4	3,18	3,73

2102

2102-X-00-XX-00-00-07-0

Swage mount in 1,32 hole

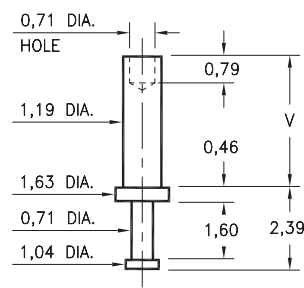

Basic Part Number	Board Thickness	Length V
2102-5	0,41	0,89
2102-1	0,79	1,37
2102-2	1,57	2,13
2102-3	2,39	2,92
2102-4	3,18	3,73

2109

2109-X-00-XX-00-00-07-0

Swage mount in 1,32 hole

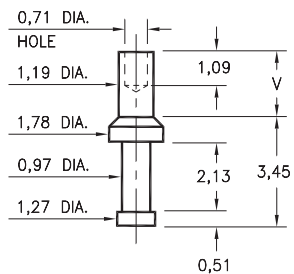

Basic Part Number	Board Thickness	Length V
2109-1	0,79	1,32
2109-2	1,57	2,16

2324

2324-2-00-XX-00-00-07-0

Swage mount in 1,32 hole
For a 1,57 thick board

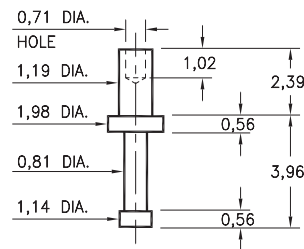

SPECIFICATIONS:

Pin Material: Brass Alloy 360, 1/2 Hard
(Swage pins are annealed)

Dimensions: Millimeters

Tolerances On: Lengths: $\pm 0,13$
Diameters: $\pm 0,051$
Angles: $\pm 2^\circ$



ORDER CODE: XXXX - X - 00 - XX - 00 - 00 - 07 - 0

BASIC PART #

SPECIFY PIN FINISH:

- 01 5,08μm TIN/LEAD OVER NICKEL
- ◆ 80 5,08μm TIN OVER NICKEL (RoHS)
- ◆ 44 7,62μm SILVER OVER COPPER (RoHS)
- 50 7,62μm ELECTRO-SOLDER
(60/40 SnPb)



MALE PCB PINS

SOLDER TERMINAL TURRETS

2312

2312-X-00-XX-00-00-07-0

Swage mount in 1,63 hole

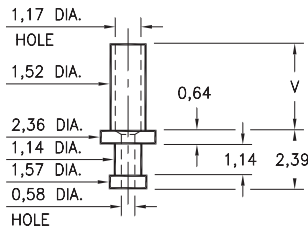

Basic Part Number	Board Thickness	Length V
2312-1	0,79	1,35
2312-2	1,57	2,39
2312-3	2,39	2,92
2312-4	3,18	3,73

2308

2308-X-00-XX-00-00-07-0

Swage mount in 1,63 hole

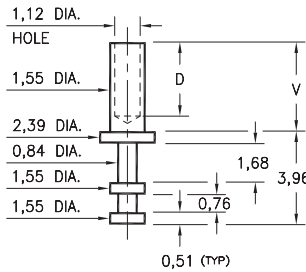

Basic Part Number	Board Thickness	Length V	Depth D
2308-1	0,79	1,37	0,91
2308-2	1,57	2,13	1,68
2308-3	2,39	2,92	2,44
2308-4	3,18	3,73	3,20

2707

2707-X-00-XX-00-00-07-0

Swage mount in 3,05 hole

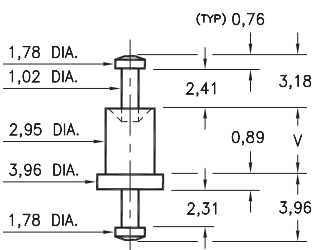

Basic Part Number	Board Thickness	Length V
2707-1	0,79	1,57
2707-2	1,57	2,39
2707-3	2,39	3,18
2707-4	3,18	3,96

2329

2329-X-00-XX-00-00-07-0

Swage mount in 1,70 hole

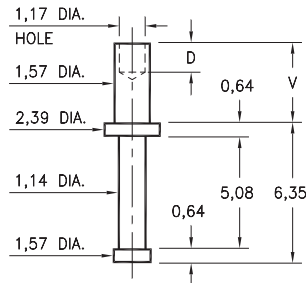

Basic Part Number	Board Thickness	Length V	Depth D
2329-1	0,79	1,14	1,14
2329-2	1,57	2,39	1,57
2329-3	2,39	3,18	1,57
2329-4	3,18	3,96	1,57

2510

2510-X-00-XX-00-00-07-0

Swage mount in 1,63 hole

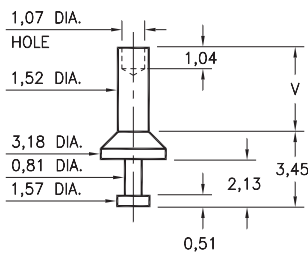

2513

2513-X-00-XX-00-00-07-0

Swage mount in 1,63 hole

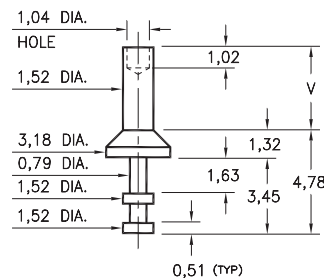

Basic Part Number	Board Thickness	Length V
251X-1	0,79	1,57
251X-2	1,57	2,39
251X-3	2,39	3,18
251X-4	3,18	3,96

SPECIFICATIONS:

Pin Material: Brass Alloy 360, 1/2 Hard
(Swage pins are annealed)

Dimensions: Millimeters

Tolerances On: Lengths: $\pm 0,13$
Diameters: $\pm 0,051$
Angles: $\pm 2^\circ$



ORDER CODE: XXXX - X - 00 - XX - 00 - 00 - 07 - 0

BASIC PART #

SPECIFY PIN FINISH:

- 01 5,08 μ m TIN/LEAD OVER NICKEL
- ◆ 80 5,08 μ m TIN OVER NICKEL (RoHS)
- ◆ 44 7,62 μ m SILVER OVER COPPER (RoHS)
- 50 7,62 μ m ELECTRO-SOLDER
(60/40 SnPb)



MALE PCB PINS

SOLDER TERMINAL TURRETS

2110

2110-X-00-XX-00-00-07-0

Swage mount in 1,32 hole

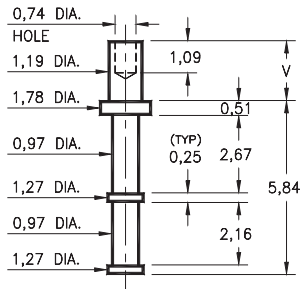

Basic Part Number	Board Thickness	Length V
2110-1	0,79	1,24
2110-2	1,57	2,08

2333

2333-X-00-XX-00-00-07-0

Press-fit & swage in 1,32 mounting hole

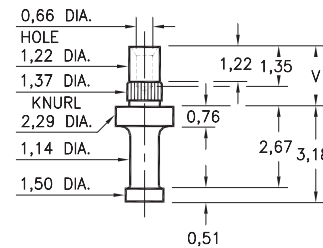

Basic Part Number	Board Thickness	Length V
2333-1	1,98	2,62
2333-2	1,57	2,21
2333-3	1,19	1,83

2821

2821-X-00-XX-00-00-07-0

Swage mount in 3,18 hole

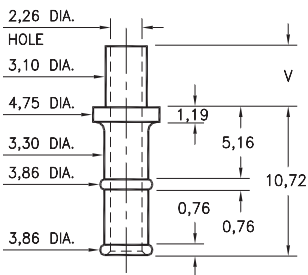

Basic Part Number	Board Thickness	Length V
2821-2	1,57	2,77
2821-3	2,39	3,58
2821-4	3,18	4,37

2533

2533-0-00-XX-00-00-07-0

Press-fit & swage in 1,32 mounting hole
For a 1,57 to 2,39 thick board

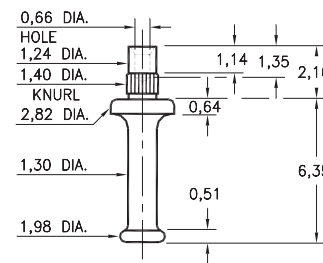

2101

2101-3-00-XX-00-00-07-0

Press-fit in 1,35 mounting hole
For a 1,57 to 2,39 thick board

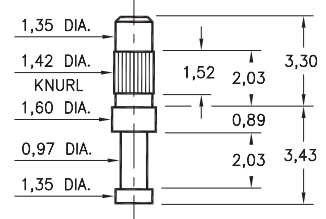

2316

2316-X-00-XX-00-00-07-0

Swage mount in 1,63 hole

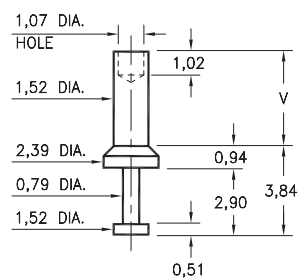

2317

2317-X-00-XX-00-00-07-0

Swage mount in 1,63 hole

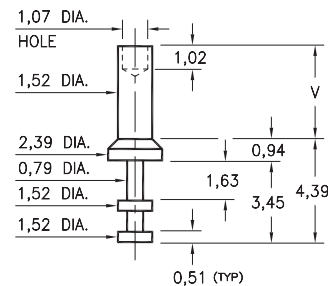

2708

2708-X-00-XX-00-00-07-0

Swage mount in 3,05 hole

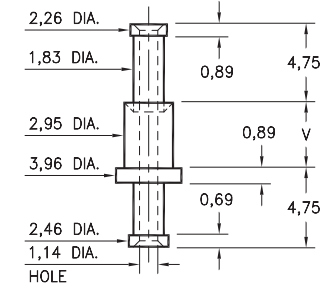

Basic Part Number	Board Thickness	Length V
2XXX-1	0,79	1,57
2XXX-2	1,57	2,39
2XXX-3	2,39	3,18
2XXX-4	3,18	3,96

SPECIFICATIONS:

Pin Material: Brass Alloy 360, 1/2 Hard
(Swage pins are annealed)

Dimensions: Millimeters

Tolerances On: Lengths: $\pm 0,13$
Diameters: $\pm 0,051$
Angles: $\pm 2^\circ$



ORDER CODE: **XXXX - X - 00 - XX - 00 - 00 - 07 - 0**

BASIC PART #

SPECIFY PIN FINISH:

- 01 5,08µm TIN/LEAD OVER NICKEL
- ◆ 80 5,08µm TIN OVER NICKEL (RoHS)
- ◆ 44 7,62µm SILVER OVER COPPER (RoHS)
- 50 7,62µm ELECTRO-SOLDER (60/40 SnPb)



MALE PCB PINS

SOLDER TERMINAL TURRETS

2348

2348-X-00-XX-00-00-07-0

Swage mount in 1,63 hole

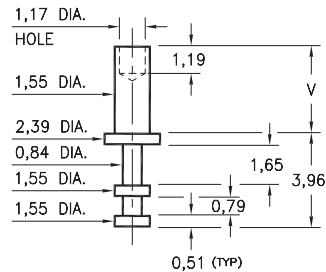

2301

2301-X-00-XX-00-00-07-0

Swage mount in 1,70 hole

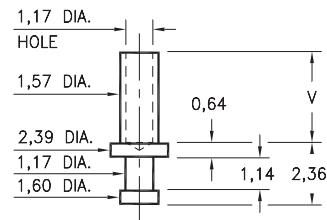

2506

2506-X-00-XX-00-00-07-0

Swage mount in 1,70 hole

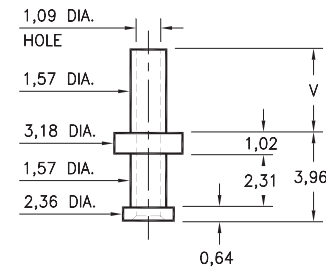

Basic Part Number	Board Thickness	Length V
2XXX-1	0,79	1,35
2XXX-2	1,57	2,13
2XXX-3	2,39	2,92
2XXX-4	3,18	3,73

2310

2310-X-00-XX-00-00-07-0

Swage mount in 1,70 hole

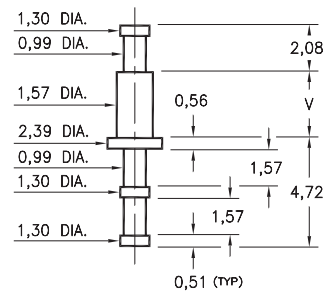

Basic Part Number	Board Thickness	Length V
2310-1	0,79	1,35
2310-2	1,57	2,08
2310-3	2,39	2,87
2310-4	3,18	3,68

2505

2505-X-00-XX-00-00-07-0

Swage mount in 1,93 hole

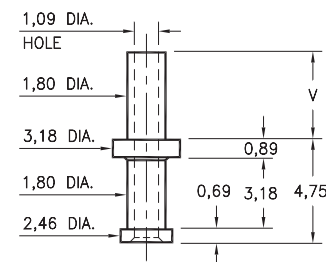

Basic Part Number	Board Thickness	Length V
2505-1	0,79	1,57
2505-2	1,57	2,36
2505-3	2,39	3,18
2505-4	3,18	3,96

2325

2325-X-00-XX-00-00-07-0

Swage mount in 1,85 hole

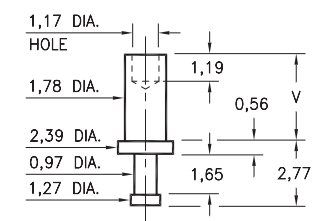

2355

2355-X-00-XX-00-00-07-0

Swage mount in 1,85 hole

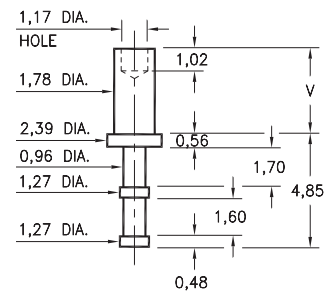

2365

2365-X-00-XX-00-00-07-0

Swage mount in 1,93 hole

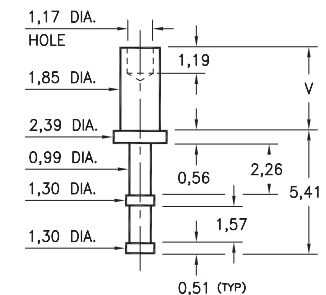

Basic Part Number	Board Thickness	Length V
23X5-1	0,79	1,35
23X5-2	1,57	2,13
23X5-3	2,39	2,92
23X5-4	3,18	3,73

SPECIFICATIONS:

Pin Material: Brass Alloy 360, 1/2 Hard
(Swage pins are annealed)

Dimensions: Millimeters

Tolerances On: Lengths: $\pm 0,13$
Diameters: $\pm 0,051$
Angles: $\pm 2^\circ$



ORDER CODE: XXXX - X - 00 - XX - 00 - 00 - 07 - 0

BASIC PART #

SPECIFY PIN FINISH:

- 01 5,08µm TIN/LEAD OVER NICKEL
- ◆ 80 5,08µm TIN OVER NICKEL (RoHS)
- ◆ 44 7,62µm SILVER OVER COPPER (RoHS)
- 50 7,62µm ELECTRO-SOLDER
(60/40 SnPb)



MALE PCB PINS

SOLDER TERMINAL TURRETS

2304

2304-X-00-XX-00-00-07-0

Swage mount in 1,93 hole

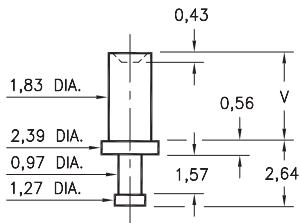

2305

2305-X-00-XX-00-00-07-0

Swage mount in 1,93 hole

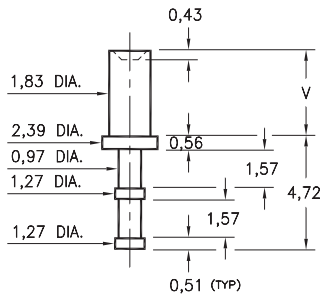

Basic Part Number	Board Thickness	Length V
230X-1	0,79	1,30
230X-2	1,57	2,08
230X-3	2,39	2,87
230X-4	3,18	3,68

2503

2503-X-00-XX-00-00-07-0

Swage mount in 2,08 hole

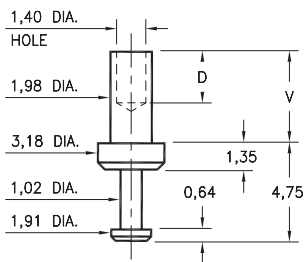

Basic Part Number	Board Thickness	Length V	Depth D
2503-1	0,79	1,98	1,72
2503-2	1,57	2,77	2,49
2503-3	2,39	3,58	2,49
2503-4	3,18	4,39	2,49

2704

2704-X-00-XX-00-00-07-0

Swage mount in 2,08 hole

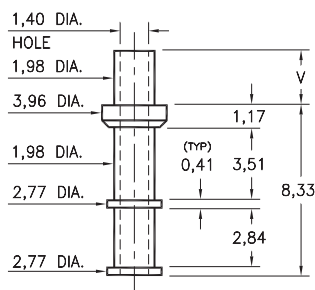

Basic Part Number	Board Thickness	Length V
2704-1	0,79	1,91
2704-2	1,57	2,67
2704-3	2,39	3,43
2704-4	3,18	4,19

2306

2306-X-00-XX-00-00-07-0

Swage mount in 1,93 hole

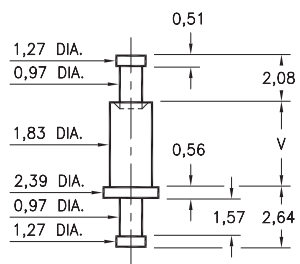

2307

2307-X-00-XX-00-00-07-0

Swage mount in 1,93 hole

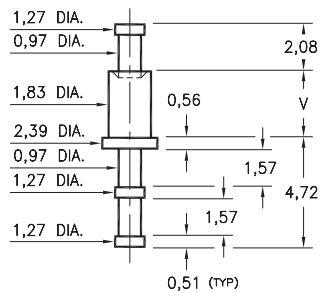

2311

2311-X-00-XX-00-00-07-0

Swage mount in 1,93 hole

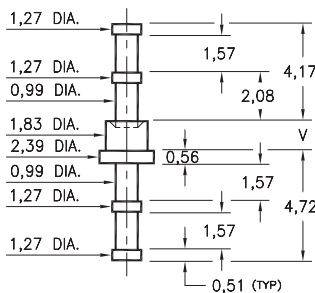

Basic Part Number	Board Thickness	Length V
23XX-1	0,79	1,30
23XX-2	1,57	2,08
23XX-3	2,39	2,87
23XX-4	3,18	3,68

SPECIFICATIONS:

Pin Material: Brass Alloy 360, 1/2 Hard
(Swage pins are annealed)

Dimensions: Millimeters

Tolerances On: Lengths: $\pm 0,13$
Diameters: $\pm 0,051$
Angles: $\pm 2^\circ$



ORDER CODE: XXXX - X - 00 - XX - 00 - 00 - 07 - 0

BASIC PART #

SPECIFY PIN FINISH:

- 01 5,08μm TIN/LEAD OVER NICKEL
- ◆ 80 5,08μm TIN OVER NICKEL (RoHS)
- ◆ 44 7,62μm SILVER OVER COPPER (RoHS)
- 50 7,62μm ELECTRO-SOLDER (60/40 SnPb)



MALE PCB PINS

SOLDER TERMINAL TURRETS

2810

2810-X-00-XX-00-00-07-0

Swage mount in 3,0 hole

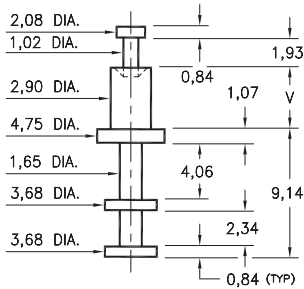

Basic Part Number	Board Thickness	Length V
2810-2	1,57	2,67
2810-3	2,39	3,43
2810-4	3,18	4,19

2524

2524-X-00-XX-00-00-07-0

Swage mount in 2,34 hole

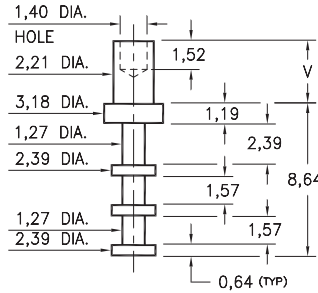

Basic Part Number	Board Thickness	Length V
2524-1	0,79	1,91
2524-2	1,57	2,67
2524-3	2,39	3,43
2524-4	3,18	4,19

2561

2561-X-00-XX-00-00-07-0

Swage mount in 2,39 hole

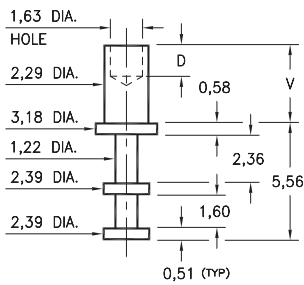

2508

2508-X-00-XX-00-00-07-0

Swage mount in 2,39 hole

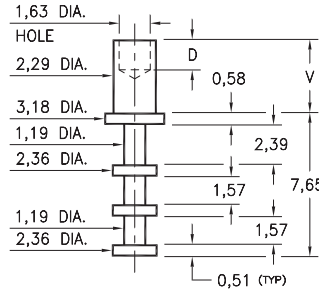

Basic Part Number	Board Thickness	Length V	Depth D
25XX-1	0,79	1,60	1,19
25XX-2	1,57	2,39	1,57
25XX-3	2,39	3,18	1,57
25XX-4	3,18	3,96	1,57

2551

2551-X-00-XX-00-00-07-0

Swage mount in 2,39 hole

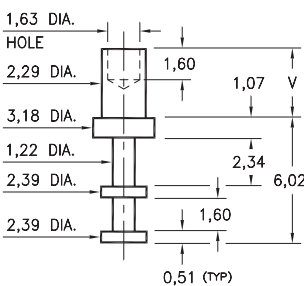

Basic Part Number	Board Thickness	Length V
2551-1	0,79	1,91
2551-2	1,57	2,67
2551-3	2,39	3,43
2551-4	3,18	4,19

2812

2812-X-00-XX-00-00-07-0

Swage mount in 2,95 hole

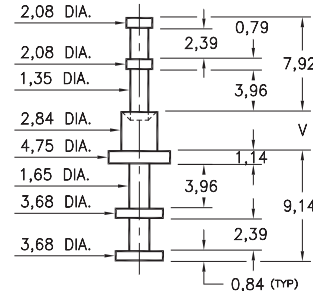

Basic Part Number	Board Thickness	Length V
2812-1	1,57	2,67
2812-2	2,39	3,43
2812-3	3,18	4,19
2812-4	4,78	5,84

SPECIFICATIONS:

Pin Material: Brass Alloy 360, 1/2 Hard
(Swage pins are annealed)

Dimensions: Millimeters

Tolerances On: Lengths: $\pm 0,13$
Diameters: $\pm 0,051$
Angles: $\pm 2^\circ$



ORDER CODE: XXXX - X - 00 - XX - 00 - 00 - 07 - 0

BASIC PART #

SPECIFY PIN FINISH:

- 01 5,08 μ m TIN/LEAD OVER NICKEL
- ◆ 80 5,08 μ m TIN OVER NICKEL (RoHS)
- ◆ 44 7,62 μ m SILVER OVER COPPER (RoHS)
- 50 7,62 μ m ELECTRO-SOLDER
(60/40 SnPb)



MALE PCB PINS

SOLDER TERMINAL TURRETS

2501

2501-X-00-XX-00-00-07-0

Swage mount in 2,39 hole

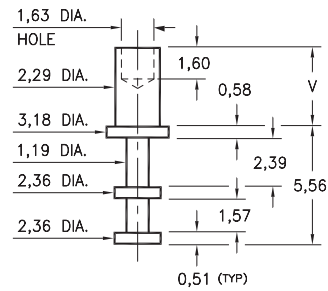

Basic Part Number	Board Thickness	Length V
2501-1	0,79	1,98
2501-2	1,57	2,77
2501-3	2,39	3,56
2501-4	3,18	4,34

2703

2703-X-00-XX-00-00-07-0

Swage mount in 2,39 hole

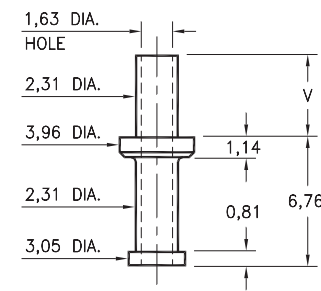

Basic Part Number	Board Thickness	Length V
2703-1	0,79	1,96
2703-2	1,57	2,72
2703-3	2,39	3,48
2703-4	3,18	4,24

2702

2702-X-00-XX-00-00-07-0

Swage mount in 2,39 hole

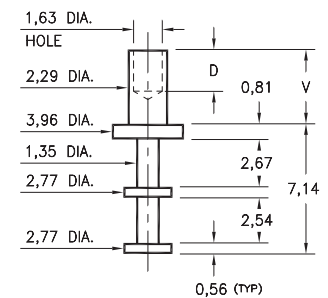

Basic Part Number	Board Thickness	Length V	Depth D
2702-1	0,79	1,91	1,60
2702-2	1,57	2,67	2,36
2702-3	2,39	3,43	2,36
2702-4	3,18	4,19	2,36

2710

2710-X-00-XX-00-00-07-0

Swage mount in 2,39 hole

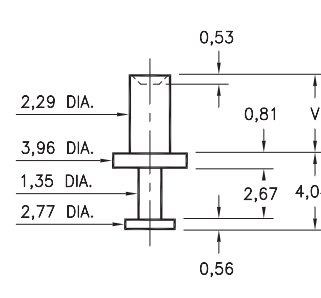

Basic Part Number	Board Thickness	Length V
2710-1	0,79	1,57
2710-2	1,57	2,39
2710-3	2,39	3,18
2710-4	3,18	3,96

2717

2717-X-00-XX-00-00-07-0

Swage mount in 2,39 hole

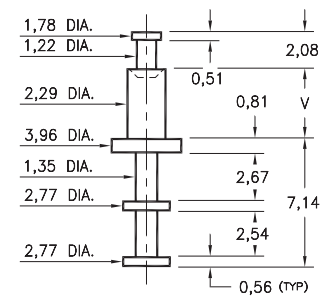

2713

2713-X-00-XX-00-00-07-0

Swage mount in 2,39 hole

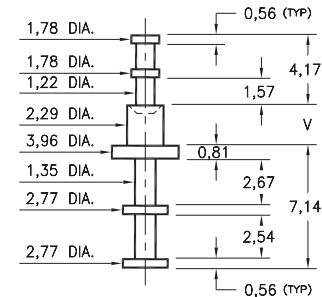

Basic Part Number	Board Thickness	Length V
271X-1	0,79	1,57
271X-2	1,57	2,39
271X-3	2,39	3,18
271X-4	3,18	3,96

SPECIFICATIONS:

Pin Material: Brass Alloy 360, 1/2 Hard
(Swage pins are annealed)

Dimensions: Millimeters

Tolerances On: Lengths: $\pm 0,13$
Diameters: $\pm 0,051$
Angles: $\pm 2^\circ$



ORDER CODE: **XXXX - X - 00 - XX - 00 - 00 - 07 - 0**

BASIC PART #

SPECIFY PIN FINISH:

- 01 5,08μm TIN/LEAD OVER NICKEL
- ◆ 80 5,08μm TIN OVER NICKEL (RoHS)
- ◆ 44 7,62μm SILVER OVER COPPER (RoHS)
- 50 7,62μm ELECTRO-SOLDER (60/40 SnPb)



MALE PCB PINS

SOLDER TERMINAL TURRETS

2512

2512-X-00-XX-00-00-07-0

Swage mount in 2,39 hole

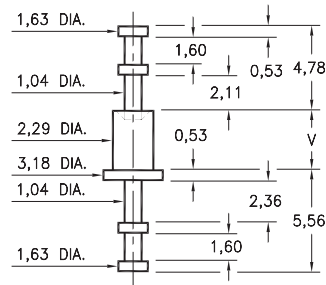

Basic Part Number	Board Thickness	Length V
2512-1	0,79	1,57
2512-2	1,57	2,39
2512-3	2,39	3,18
2512-4	3,18	3,96

2705

2705-X-00-XX-00-00-07-0

Swage mount in 3,28 hole

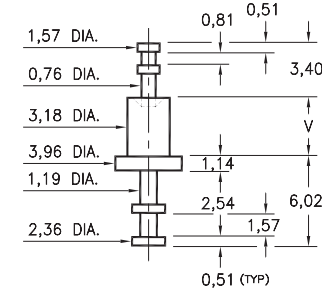

Basic Part Number	Board Thickness	Length V
2705-1	0,79	1,91
2705-2	1,57	2,67
2705-3	2,39	3,43
2705-4	3,18	4,19

2803

2803-X-00-XX-00-00-07-0

Swage mount in 2,87 hole

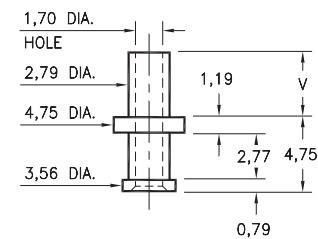

Basic Part Number	Board Thickness	Length V
2803-1	0,79	1,98
2803-2	1,57	2,77
2803-3	2,39	3,56
2803-4	3,18	4,34

2815

2815-X-00-XX-00-00-07-0

Swage mount in 2,87 hole

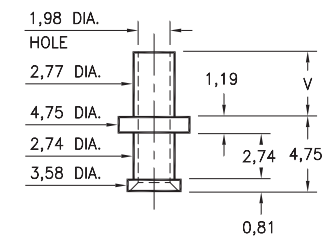

Basic Part Number	Board Thickness	Length V
2815-1	0,79	1,91
2815-2	1,57	2,67
2815-3	2,39	3,43
2815-4	3,18	4,19

2816

2816-X-00-XX-00-00-07-0

Swage mount in 2,95 hole

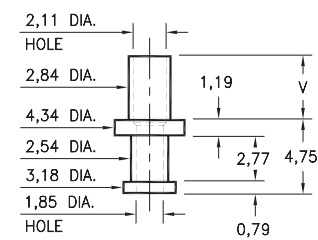

Basic Part Number	Board Thickness	Length V
2816-1	0,79	1,98
2816-2	1,57	2,77
2816-3	2,39	3,58
2816-4	3,18	4,37

2817

2817-X-00-XX-00-00-07-0

Swage mount in 2,95 hole

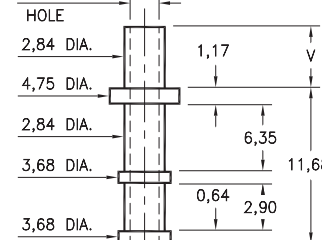

Basic Part Number	Board Thickness	Length V
2817-1	0,79	1,91
2817-2	1,57	2,67
2817-3	2,39	3,43
2817-4	3,18	4,19

SPECIFICATIONS:

Pin Material: Brass Alloy 360, 1/2 Hard
(Swage pins are annealed)

Dimensions: Millimeters

Tolerances On: Lengths: $\pm 0,13$
Diameters: $\pm 0,051$
Angles: $\pm 2^\circ$



ORDER CODE: **XXXX - X - 00 - XX - 00 - 00 - 07 - 0**

BASIC PART #

SPECIFY PIN FINISH:

- 01** 5,08 μ m TIN/LEAD OVER NICKEL
- 80** 5,08 μ m TIN OVER NICKEL (RoHS)
- 44** 7,62 μ m SILVER OVER COPPER (RoHS)
- 50** 7,62 μ m ELECTRO-SOLDER
(60/40 SnPb)



MALE PCB PINS

SOLDER TERMINAL TURRETS

2802

2802-X-00-XX-00-00-07-0

Swage mount in 3,0 hole

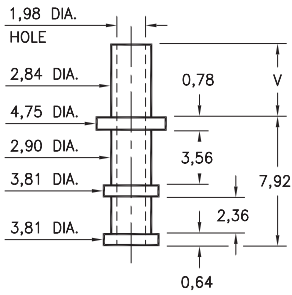

2804

2804-X-00-XX-00-00-07-0

Swage mount in 3,0 hole

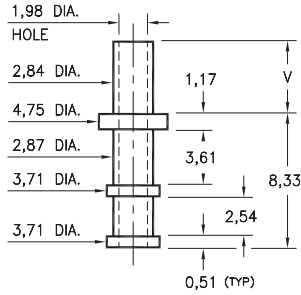

Basic Part Number	Board Thickness	Length V
280X-1	0,79	1,98
280X-2	1,57	2,77
280X-3	2,39	3,56
280X-4	3,18	4,34

2805

2805-X-00-XX-00-00-07-0

Swage mount in 2,95 hole

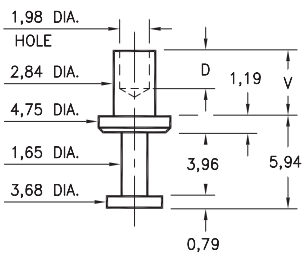

Basic Part Number	Board Thickness	Length V	Depth D
2805-1	0,79	1,88	1,73
2805-2	1,57	2,67	2,49
2805-3	2,39	3,43	2,49
2805-4	3,18	4,19	2,49

2801

2801-X-00-XX-00-00-07-0

Swage mount in 2,95 hole

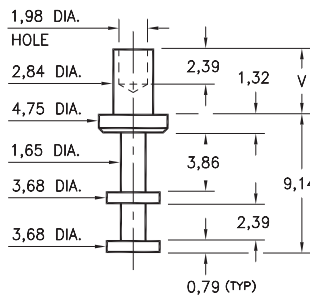

Basic Part Number	Board Thickness	Length V
2801-1	0,79	1,98
2801-2	1,57	2,77
2801-3	2,39	3,58
2801-4	3,18	4,37
2801-5	4,76	5,94

2806

2806-X-00-XX-00-00-07-0

Swage mount in 2,95 hole

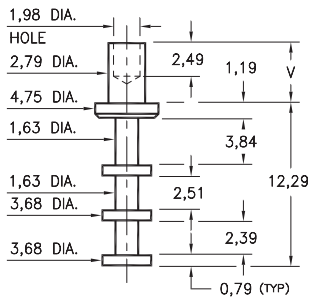

Basic Part Number	Board Thickness	Length V
2806-1	0,79	1,98
2806-2	1,57	2,77
2806-3	2,39	3,58
2806-4	3,18	4,37

2811

2811-X-00-XX-00-00-07-0

Swage mount in 2,95 hole

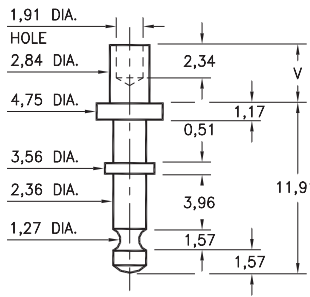

Basic Part Number	Board Thickness	Length V
2811-1	0,79	1,91
2811-2	1,57	2,67
2811-3	2,39	3,43
2811-4	3,18	4,19

SPECIFICATIONS:

Pin Material: Brass Alloy 360, 1/2 Hard
(Swage pins are annealed)

Dimensions: Millimeters

Tolerances On: Lengths: $\pm 0,13$
Diameters: $\pm 0,051$
Angles: $\pm 2^\circ$



ORDER CODE: XXXX - X - 00 - XX - 00 - 00 - 07 - 0

BASIC PART #

SPECIFY PIN FINISH:

- 01 5,08 μ m TIN/LEAD OVER NICKEL
- ◆ 80 5,08 μ m TIN OVER NICKEL (RoHS)
- ◆ 44 7,62 μ m SILVER OVER COPPER (RoHS)
- 50 7,62 μ m ELECTRO-SOLDER (60/40 SnPb)



MALE PCB PINS

SOLDER TERMINALS SLOTTED

2104

2104-X-01-XX-00-00-07-0

Swage mount in 0,91 hole

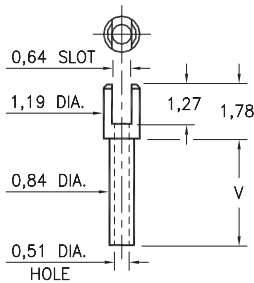

Basic Part Number	Board Thickness	Length V
2104-1	0,79	1,40
2104-2	1,57	2,18
2104-3	2,39	2,97
2104-4	3,18	3,76

2112

2112-X-01-XX-00-00-07-0

Swage mount in 1,09 hole

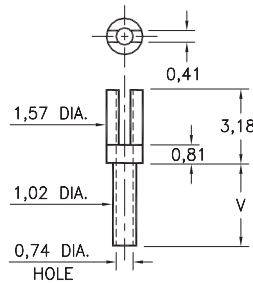

Basic Part Number	Board Thickness	Length V
2112-5	0,41	0,94
2112-1	0,79	1,35
2112-2	1,57	2,13
2112-3	2,39	2,92
2112-4	3,18	3,73

2105

2105-X-01-XX-00-00-07-0

Swage mount in 1,32 hole

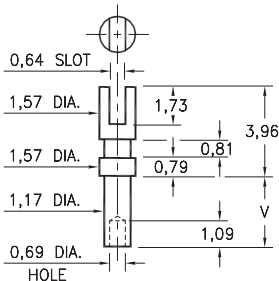

Basic Part Number	Board Thickness	Length V
2105-1	0,79	1,40
2105-2	1,57	2,18
2105-3	2,39	2,97
2105-4	3,18	3,78

2103

2103-X-01-XX-00-00-07-0

Swage mount in 1,32 hole

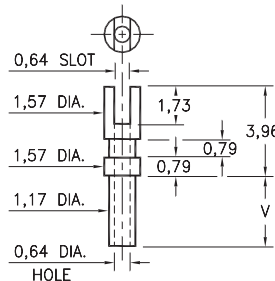

Basic Part Number	Board Thickness	Length V
2103-1	0,79	1,4
2103-2	1,57	2,18
2103-3	2,39	2,97
2103-4	3,18	3,78

2106

2106-X-01-XX-00-00-07-0

Swage mount in 1,32 hole

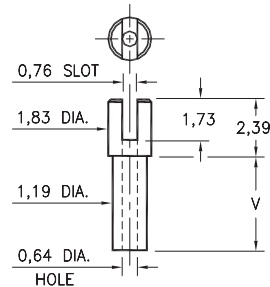

2107

2107-X-01-XX-00-00-07-0

Swage mount in 1,32 hole

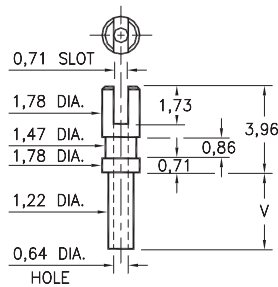

Basic Part Number	Board Thickness	Length V
210X-1	0,79	1,30
210X-2	1,57	2,08
210X-3	2,39	2,87
210X-4	3,18	3,68

6620

6620-0-35-XX-00-00-03-0

Solder mount in 1,63 mounting hole

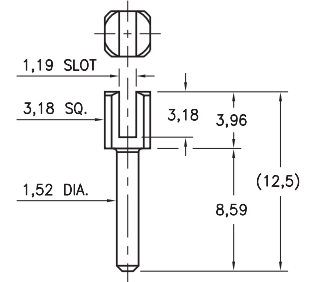

SPECIFICATIONS:

Pin Material: Brass Alloy 360, 1/2 Hard
(Swage pins are annealed)

Dimensions: Millimeters

Tolerances On: Lengths: $\pm 0,13$
Diameters: $\pm 0,051$
Angles: $\pm 2^\circ$



ORDER CODE: **XXXX - X - 01 - XX - 00 - 00 - 07 - 0**

BASIC PART #

SPECIFY PIN FINISH:

- 01 5,08 μ m TIN/LEAD OVER NICKEL
- ◆ 80 5,08 μ m TIN OVER NICKEL (RoHS)
- ◆ 44 7,62 μ m SILVER OVER COPPER (RoHS)
- 50 7,62 μ m ELECTRO-SOLDER
(60/40 SnPb)



MALE PCB PINS

SOLDER TERMINALS SLOTTED

2303

2303-X-01-XX-00-00-07-0

Swage mount in 1,63 hole

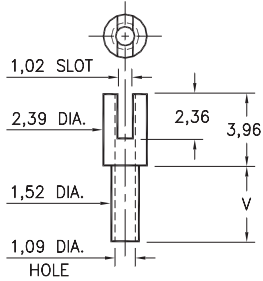

2323

2323-X-01-XX-00-00-07-0

Swage mount in 1,63 hole

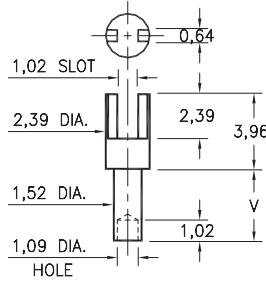

2322

2322-X-01-XX-00-00-07-0

Swage mount in 1,63 hole

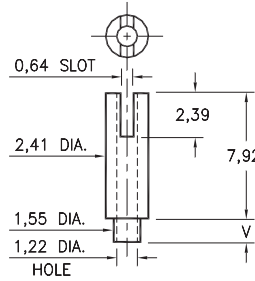

Basic Part Number	Board Thickness	Length V
23XX-1	0,79	1,35
23XX-2	1,57	2,13
23XX-3	2,39	2,92
23XX-4	3,18	3,73

2320

2320-X-01-XX-00-00-07-0

Swage mount in 1,63 hole

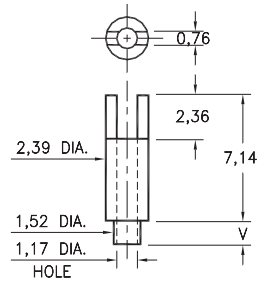

Basic Part Number	Board Thickness	Length V
2320-1	0,79	1,35
2320-2	1,57	2,13
2320-3	2,39	2,92

2328

2328-X-01-XX-00-00-07-0

Swage mount in 1,63 hole

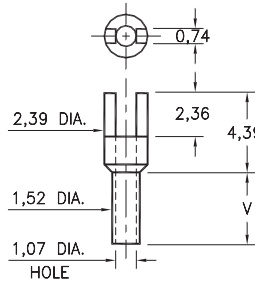

Basic Part Number	Board Thickness	Length V
2328-1	0,79	1,57
2328-2	1,57	2,39
2328-3	2,39	3,18
2328-4	3,18	3,96

2520

2520-X-01-XX-00-00-07-0

Swage mount in 1,63 hole

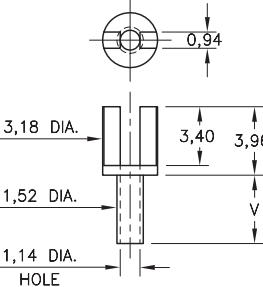

2517

2517-X-01-XX-00-00-07-0

Swage mount in 1,63 hole

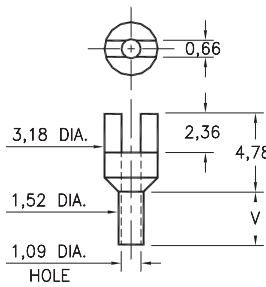

Basic Part Number	Board Thickness	Length V
25XX-1	0,79	1,57
25XX-2	1,57	2,39
25XX-3	2,39	3,18
25XX-4	3,18	3,96

SPECIFICATIONS:

Pin Material: Brass Alloy 360, 1/2 Hard
(Swage pins are annealed)

Dimensions: Millimeters

Tolerances On: Lengths: $\pm 0,13$
Diameters: $\pm 0,051$
Angles: $\pm 2^\circ$



ORDER CODE: XXXX - X - 01 - XX - 00 - 00 - 07 - 0

BASIC PART #

SPECIFY PIN FINISH:

- 01 5,08 μ m TIN/LEAD OVER NICKEL
- ◆ 80 5,08 μ m TIN OVER NICKEL (RoHS)
- ◆ 44 7,62 μ m SILVER OVER COPPER (RoHS)
- 50 7,62 μ m ELECTRO-SOLDER
(60/40 SnPb)



WIRE TERMINATION

LOOSE PINS, RECEPTACLES AND SPRING PINS

Mill-Max manufactures many different types of pins and receptacles for terminating wires. There are solder cup and crimp barrel styles for terminating discrete wires to boards, making up cable assemblies or converting device wires to pluggable pins. We have slotted and turret styles for connecting power and ground wires or for test and jumper applications. Wrapost termination styles are also available for prototyping and test. Along with our wide selection of standard products, custom designs are available by contacting Mill-Max Technical Services.

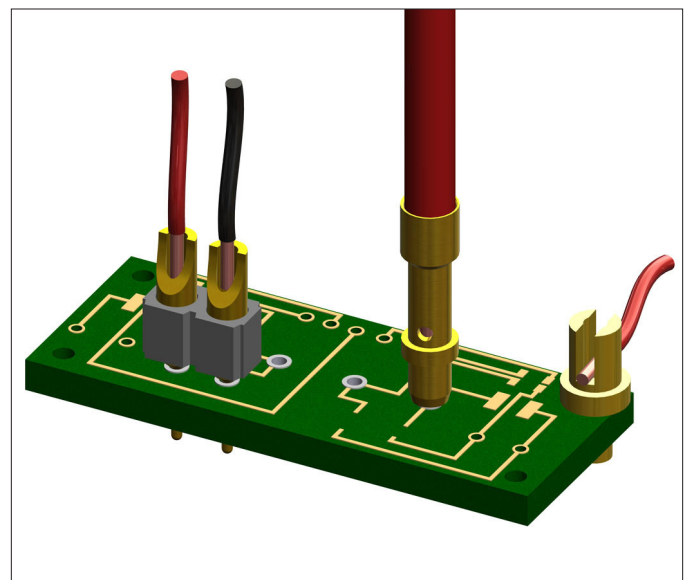
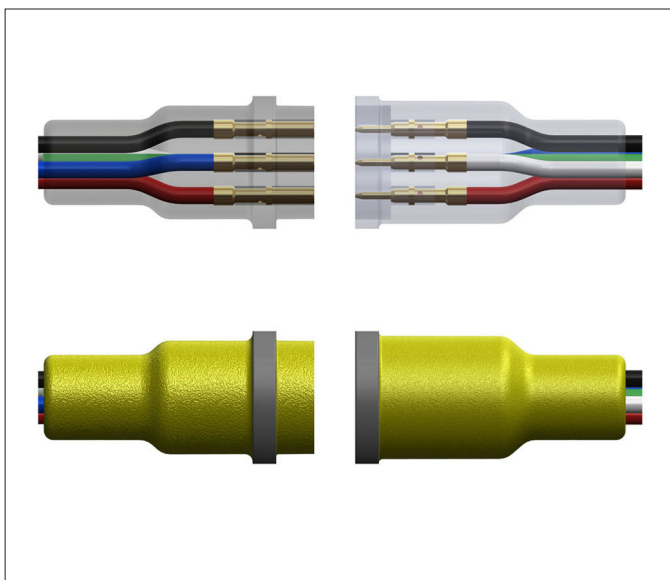
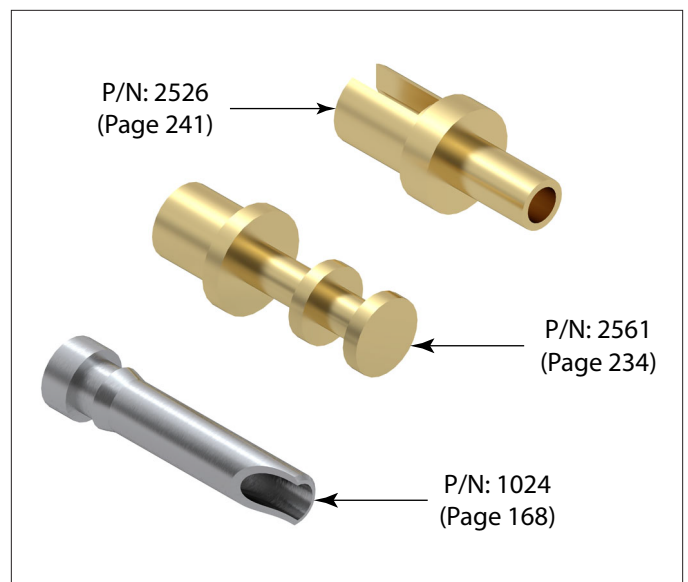
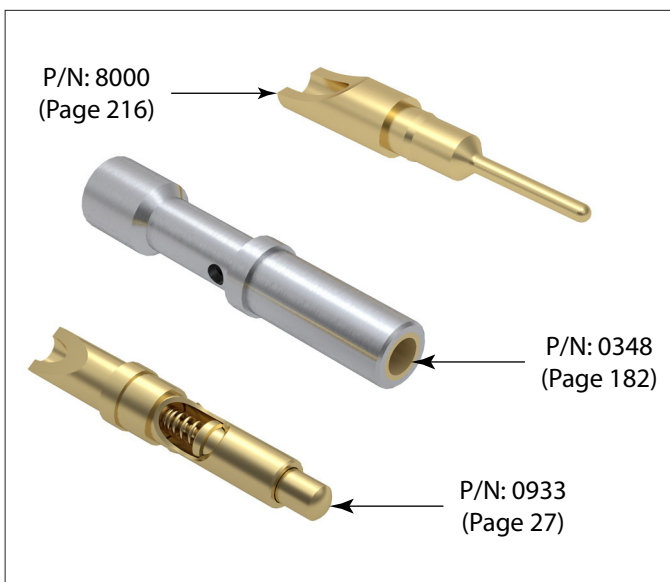

MALE PCB PINS

SOLDER TERMINALS SLOTTED

2315

2315-X-01-XX-00-00-07-0

Swage mount in 1,70 hole

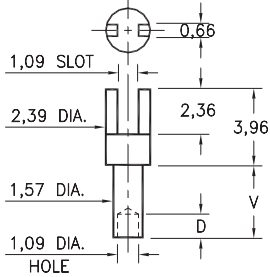

Basic Part Number	Board Thickness	Length V	Depth D
2315-1	0,79	1,14	1,02
2315-2	1,57	2,39	1,57
2315-3	2,39	3,18	1,57
2315-4	3,18	3,96	1,57

2302

2302-X-01-XX-00-00-07-0

Swage mount in 1,70 hole

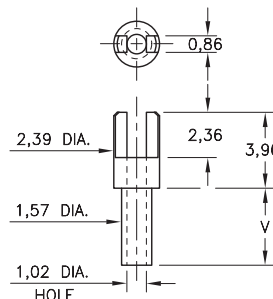

Basic Part Number	Board Thickness	Length V
2302-1	0,79	1,35
2302-2	1,57	2,13
2302-3	2,39	2,92
2302-4	3,18	3,73

2352

2352-X-01-XX-00-00-07-0

Swage mount in 1,70 hole

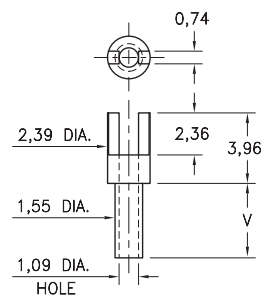

Basic Part Number	Board Thickness	Length V
2352-1	0,79	1,14
2352-2	1,57	2,39
2352-3	2,39	3,18
2352-4	3,18	3,96

2362

2362-X-01-XX-00-00-07-0

Swage mount in 1,70 hole

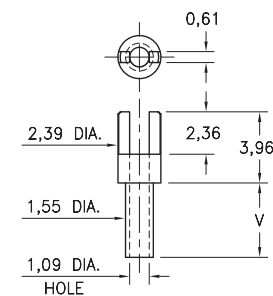

Basic Part Number	Board Thickness	Length V
2362-5	0,41	0,94
2362-1	0,79	1,35
2362-2	1,57	2,13
2362-3	2,39	2,92
2362-4	3,18	3,73

2507

2507-X-01-XX-00-00-07-0

Swage mount in 1,70 hole

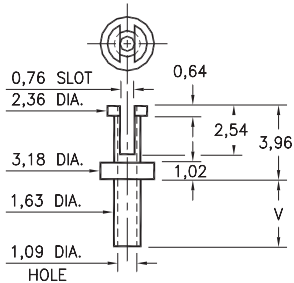

2526

2526-X-01-XX-00-00-07-0

Swage mount in 1,63 hole

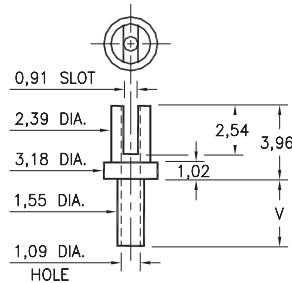

Basic Part Number	Board Thickness	Length V
25XX-1	0,79	1,35
25XX-2	1,57	2,13
25XX-3	2,39	2,92
25XX-4	3,18	3,73

SPECIFICATIONS:

Pin Material: Brass Alloy 360, 1/2 Hard
(Swage pins are annealed)

Dimensions: Millimeters

Tolerances On: Lengths: $\pm 0,13$
Diameters: $\pm 0,051$
Angles: $\pm 2^\circ$



ORDER CODE: XXXX - X - 01 - XX - 00 - 00 - 07 - 0

BASIC PART #

SPECIFY PIN FINISH:

- 01 5,08 μ m TIN/LEAD OVER NICKEL
- ◆ 80 5,08 μ m TIN OVER NICKEL (RoHS)
- ◆ 44 7,62 μ m SILVER OVER COPPER (RoHS)
- 50 7,62 μ m ELECTRO-SOLDER
(60/40 SnPb)



MALE PCB PINS

SOLDER TERMINALS SLOTTED

2314

2314-X-01-XX-00-00-07-0

Swage mount in 1,93 hole

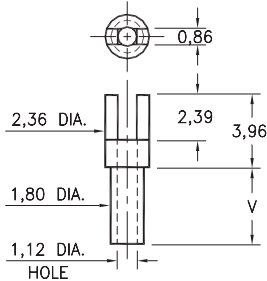

Basic Part Number	Board Thickness	Length V
2314-1	0,79	1,14
2314-2	1,57	2,39
2314-3	2,39	3,18
2314-4	3,18	3,96

2511

2511-X-01-XX-00-00-07-0

Swage mount in 1,93 hole

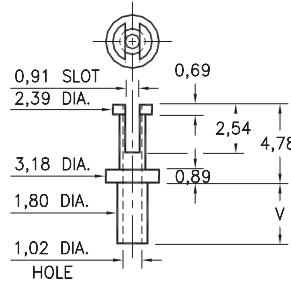

Basic Part Number	Board Thickness	Length V
2511-1	0,79	1,60
2511-2	1,57	2,39
2511-3	2,39	3,18
2511-4	3,18	3,96

2515

2515-X-01-XX-00-00-07-0

Swage mount in 2,39 hole

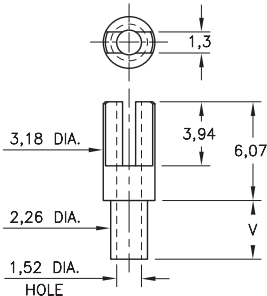

2516

2516-X-01-XX-00-00-07-0

Swage mount in 2,39 hole

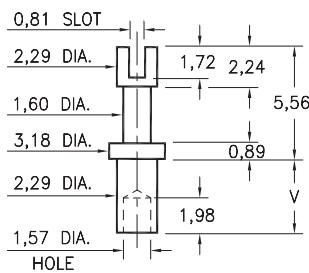

Basic Part Number	Board Thickness	Length V
251X-1	0,79	1,91
251X-2	1,57	2,67
251X-3	2,39	3,43
251X-4	3,18	3,73

2502

2502-X-01-XX-00-00-07-0

Swage mount in 2,39 hole

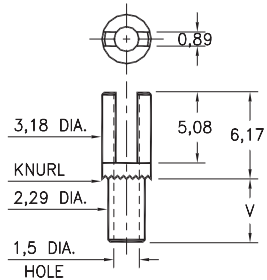

Basic Part Number	Board Thickness	Length V
2502-1	0,79	2,03
2502-2	1,57	2,82
2502-3	2,39	3,63
2502-4	3,18	4,42

SPECIFICATIONS:

Pin Material: Brass Alloy 360, 1/2 Hard
(Swage pins are annealed)

Dimensions: Millimeters

Tolerances On: Lengths: $\pm 0,13$
Diameters: $\pm 0,051$
Angles: $\pm 2^\circ$



ORDER CODE: XXXX - X - 01 - XX - 00 - 00 - 07 - 0

BASIC PART #

SPECIFY PIN FINISH:

- 01 5,08 μ m TIN/LEAD OVER NICKEL
- ◆ 80 5,08 μ m TIN OVER NICKEL (RoHS)
- ◆ 44 7,62 μ m SILVER OVER COPPER (RoHS)
- 50 7,62 μ m ELECTRO-SOLDER
(60/40 SnPb)



MALE PCB PINS

SOLDER TERMINALS VARIOUS TYPES

2709

2709-X-07-XX-00-00-07-0

Swage mount in 2,95 hole

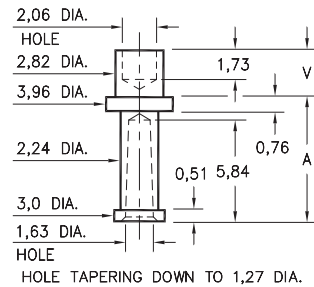

Basic Part Number	Board Thickness	Length V	Length A
2709-2	1,57	2,77	7,14
2709-3	2,39	3,58	6,35

2115

2115-2-00-XX-00-00-07-0

Swage mount in 1,09 hole
For a 1,57 thick board

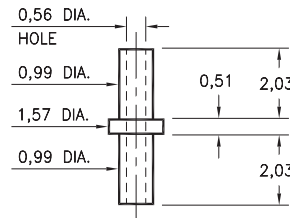

2326

2326-2-00-XX-00-00-07-0

Swage mount in 1,40 hole
For a 1,57 thick board

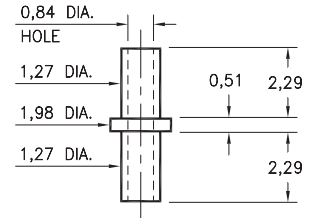

6430

6430-0-00-XX-00-00-03-0

Press-fit in 0,64 mounting hole

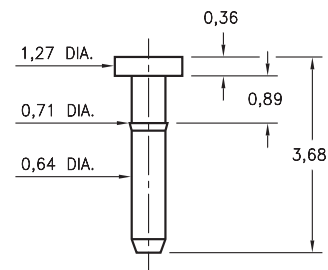

5731

5731-0-00-XX-00-00-03-0

Press-fit in .056 mounting hole

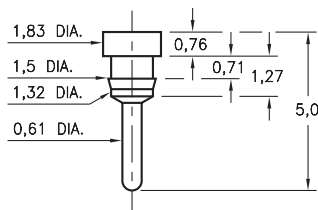

8831

8831-0-00-XX-00-00-03-0

Press-fit in 1,45 mounting hole

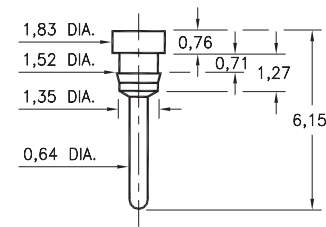

0995

0995-0-00-XX-00-00-03-0

Press-fit in 1,45 mounting hole

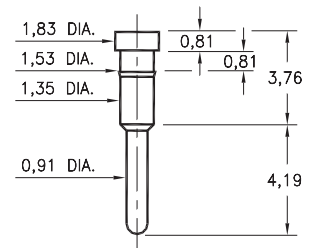

8835

8835-0-00-XX-00-00-03-0

Press-fit in 1,45 mounting hole

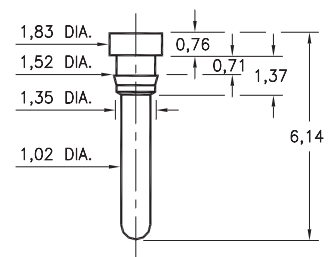

5130

5130-0-00-XX-00-00-03-0

Press-fit in .056 mounting hole

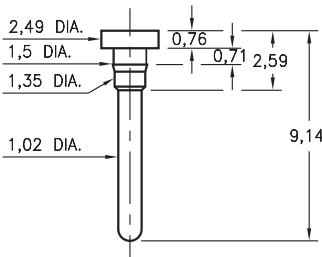

SPECIFICATIONS:

Pin Material: Brass Alloy 360, 1/2 Hard
(Swage pins are annealed)

Dimensions: Millimeters

Tolerances On: Lengths: $\pm 0,13$
Diameters: $\pm 0,051$
Angles: $\pm 2^\circ$



ORDER CODE: XXXX - X - XX - XX - 00 - 00 - XX - 0

BASIC PART #

SPECIFY PIN FINISH:

- 01 5,08 μ m TIN/LEAD OVER NICKEL
- ◆ 80 5,08 μ m TIN OVER NICKEL (RoHS)
- ◆ 44 7,62 μ m SILVER OVER COPPER (RoHS)
- 50 7,62 μ m ELECTRO-SOLDER
(60/40 SnPb)



MALE PCB PINS

SOLDER TERMINALS PIN TYPE

2318

2318-X-00-XX-00-00-07-0

Swage mount in 1,57 hole

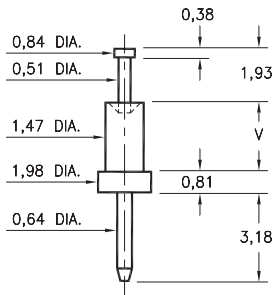

Basic Part Number	Board Thickness	Length V
2318-1	0,79	1,30
2318-2	1,57	2,08
2318-3	2,39	2,87

2309

2309-X-00-XX-00-00-07-0

Swage mount in 1,63 hole

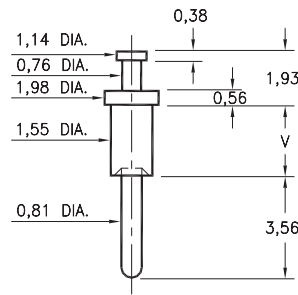

Basic Part Number	Board Thickness	Length V
2309-1	0,79	1,37
2309-2	1,57	2,13
2309-3	2,39	2,92
2309-4	3,18	3,73

2514

2514-2-00-XX-00-00-07-0

Press-fit in 1,78 mounting hole

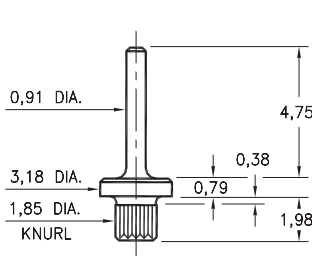

8602

8602-1-00-XX-00-00-07-0

Square press-fit in 0,81 plated through-hole

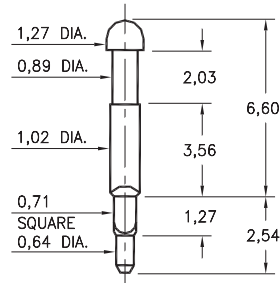

3050

3050-X-01-XX-00-00-03-0

Press-fit in 0,81 mounting hole
For wire sizes up to 26 AWG

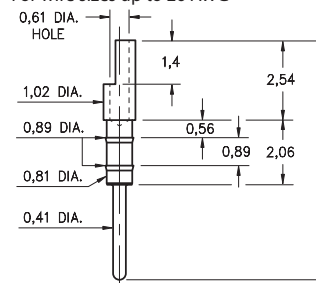

Basic Part Number	Pin Length A
3050-0	7,7
3050-3	9,55

8250

8250-0-00-XX-00-00-03-0

Press-fit in 0,86 mounting hole

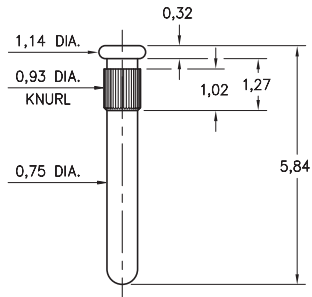

9994

9994-0-00-XX-00-00-03-0

Press-fit in 0,84 mounting hole

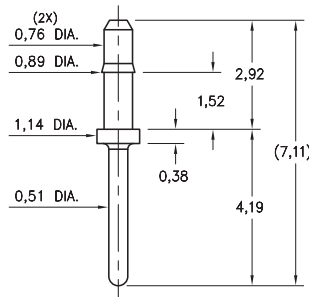

9067

9067-0-00-XX-00-00-03-0

Press-fit in 1,4 mounting hole

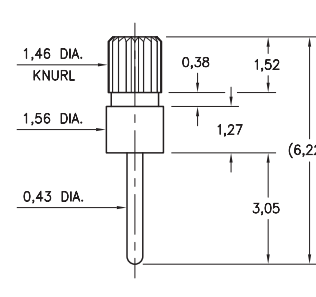

SPECIFICATIONS:

Pin Material: Brass Alloy 360, 1/2 Hard
(Swage pins are annealed)

Dimensions: Millimeters

Tolerances On: Lengths: $\pm 0,13$
Diameters: $\pm 0,051$
Angles: $\pm 2^\circ$



ORDER CODE: XXXX - X - 00 - XX - 00 - 00 - 07 - 0

BASIC PART #

SPECIFY PIN FINISH:

- 01 5,08 μ m TIN/LEAD OVER NICKEL
- ◆ 80 5,08 μ m TIN OVER NICKEL (RoHS)
- ◆ 44 7,62 μ m SILVER OVER COPPER (RoHS)
- 50 7,62 μ m ELECTRO-SOLDER
(60/40 SnPb)



MALE PCB PINS

SOLDER TERMINALS PIN TYPE

2319

2319-X-00-XX-00-00-07-0

Swage mount in 1,93 hole

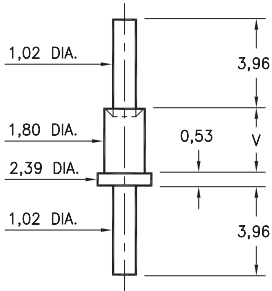

Basic Part Number	Board Thickness	Length V
2319-1	0,79	1,30
2319-2	1,57	2,08
2319-3	2,39	2,87

2313

2313-X-00-XX-00-00-07-0

Swage mount in 1,93 hole

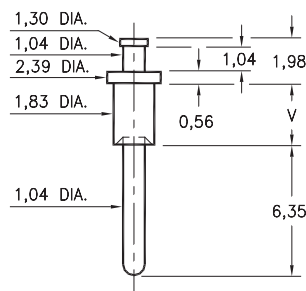

Basic Part Number	Board Thickness	Length V
2313-1	0,79	1,30
2313-2	1,57	2,13
2313-3	2,39	2,87
2313-4	3,18	3,68

2321

2321-X-00-XX-00-00-07-0

Swage mount in 1,93 hole

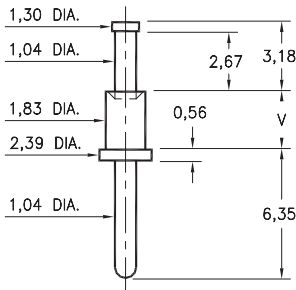

Basic Part Number	Board Thickness	Length V
2321-1	0,79	1,30
2321-2	1,57	2,08
2321-3	2,39	2,87
2321-4	3,18	3,68

2706

2706-X-00-XX-00-00-07-0

Swage mount in 3,05 hole

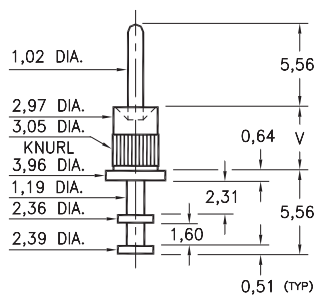

Basic Part Number	Board Thickness	Length V
2706-1	0,79	1,60
2706-2	1,57	2,36
2706-3	2,39	3,18
2706-4	3,18	3,96

2530

2530-X-00-XX-00-00-07-0

Swage mount in 2,39 hole

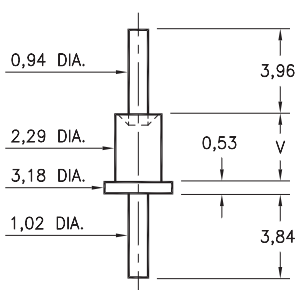

Basic Part Number	Board Thickness	Length V
2530-2	1,57	2,39
2530-3	2,39	3,18
2530-4	3,18	3,96

3156

3156-X-00-XX-00-00-08-0

Swage mount in 1,93 hole

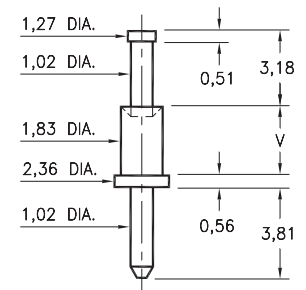

Basic Part Number	Board Thickness	Length V
3156-1	0,79	1,30
3156-2	1,57	2,08
3156-3	2,39	2,87
3156-4	3,18	3,68

SPECIFICATIONS:

Pin Material: Brass Alloy 360, 1/2 Hard
(Swage pins are annealed)

Dimensions: Millimeters

Tolerances On: Lengths: $\pm 0,13$
Diameters: $\pm 0,051$
Angles: $\pm 2^\circ$



ORDER CODE: XXXX - X - 00 - XX - 00 - 00 - XX - 0

BASIC PART #

SPECIFY PIN FINISH:

- 01 5,08 μ m TIN/LEAD OVER NICKEL
- ◆ 80 5,08 μ m TIN OVER NICKEL (RoHS)
- ◆ 44 7,62 μ m SILVER OVER COPPER (RoHS)
- 50 7,62 μ m ELECTRO-SOLDER
(60/40 SnPb)

